

### Problem T12

Consider the following relaxation-oscillator circuit, constructed from an ideal op-amp:

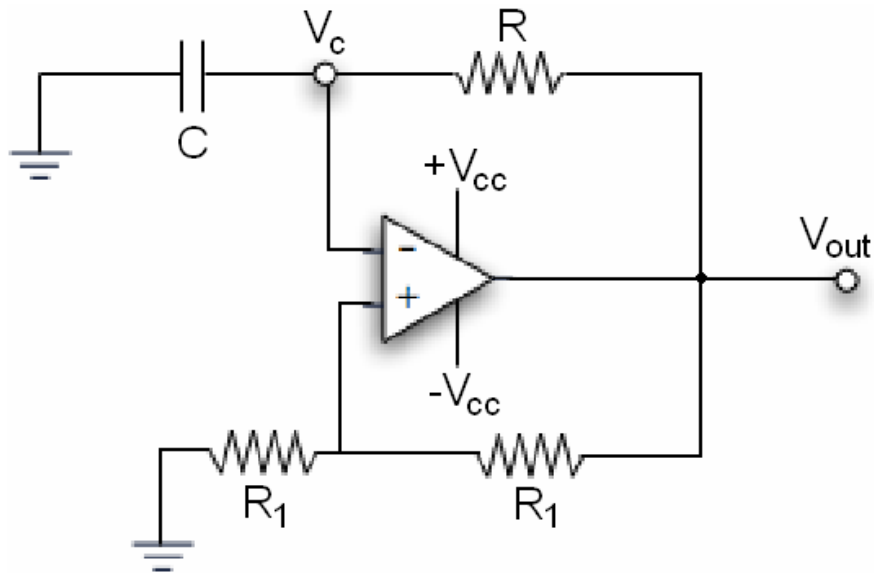

- If  $V_{out} = +V_{cc}$ , what is  $V_+$  (the voltage at the non-inverting input)?
- Does  $V_-$  (the voltage at the inverting input) always equal  $V_+$ ? If not, how do you justify the violation of Golden Rule #1?
- Plot  $V_c$  versus time; be sure to indicate the scale of the vertical and horizontal axes.