

# Two Dimensional Quantum Wells

- Quasi-2D properties
- Growth technique
- Basic spectroscopy (eg. Absorption spectroscopy)
- Conclusion

# Quantization

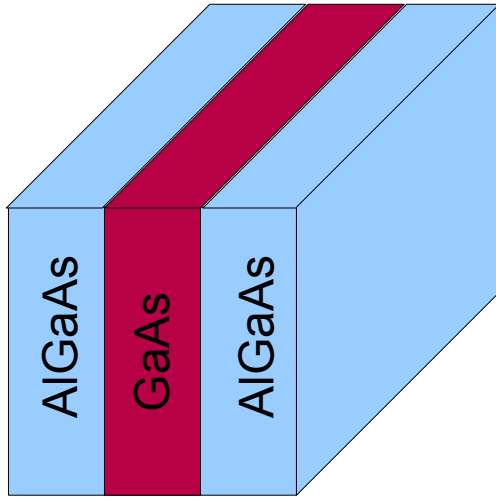

$$-\frac{\hbar^2}{2m} \frac{d^2\psi}{dx^2} + V(x)\psi = E\psi$$

$$\frac{\sqrt{2m(V-E)}}{\hbar} = \begin{cases} k \tan(ka) \\ -k \cot(ka) \end{cases}$$

e.g. GaAs / AlGaAs Conduction band

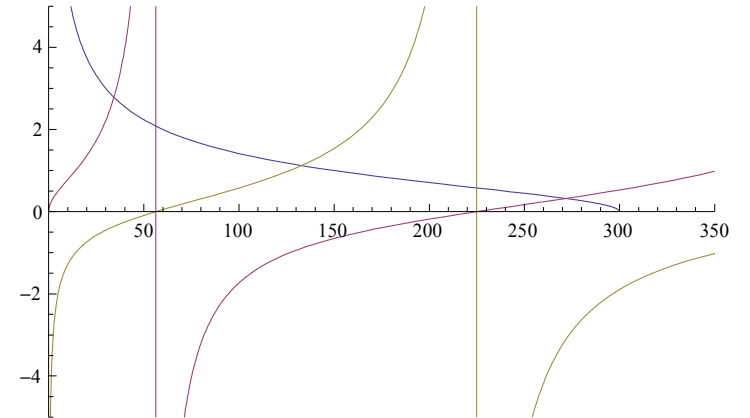
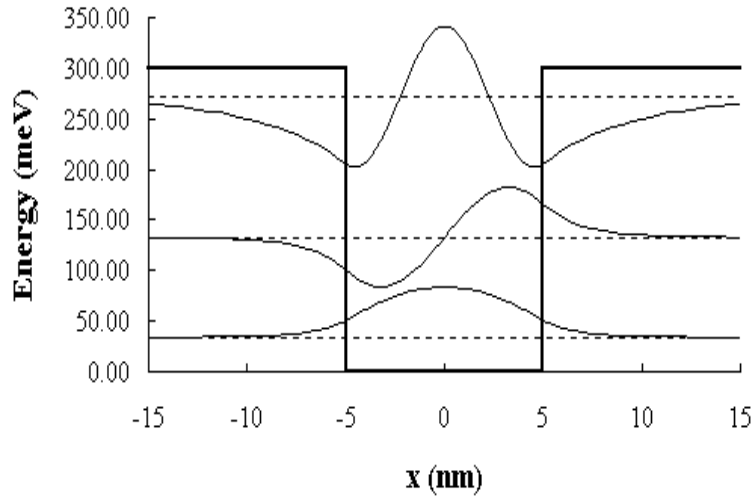
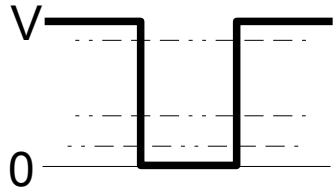

Ideal 2D systems

$$DOS = \frac{m}{\pi \hbar^2}$$

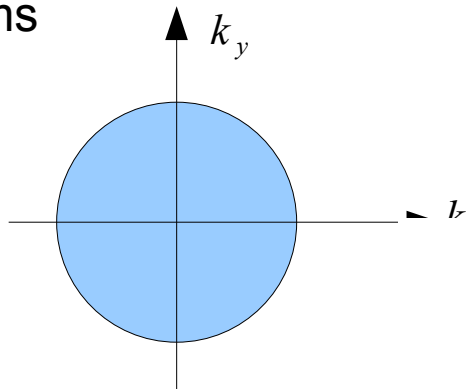

QW is a quasi-2D system.

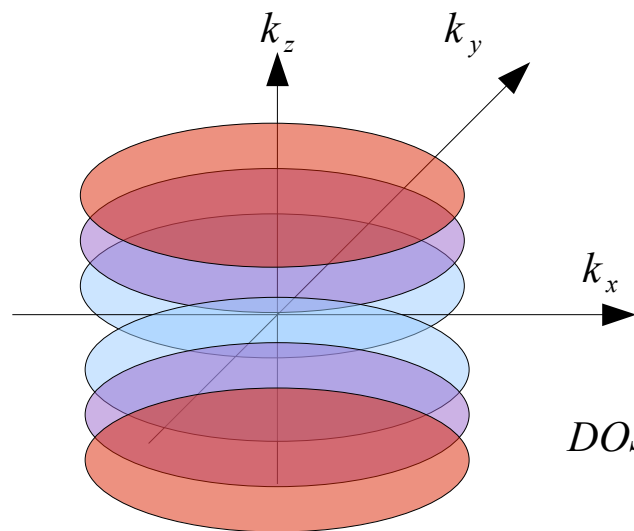

$$DOS = n \frac{m}{\pi \hbar^2}$$

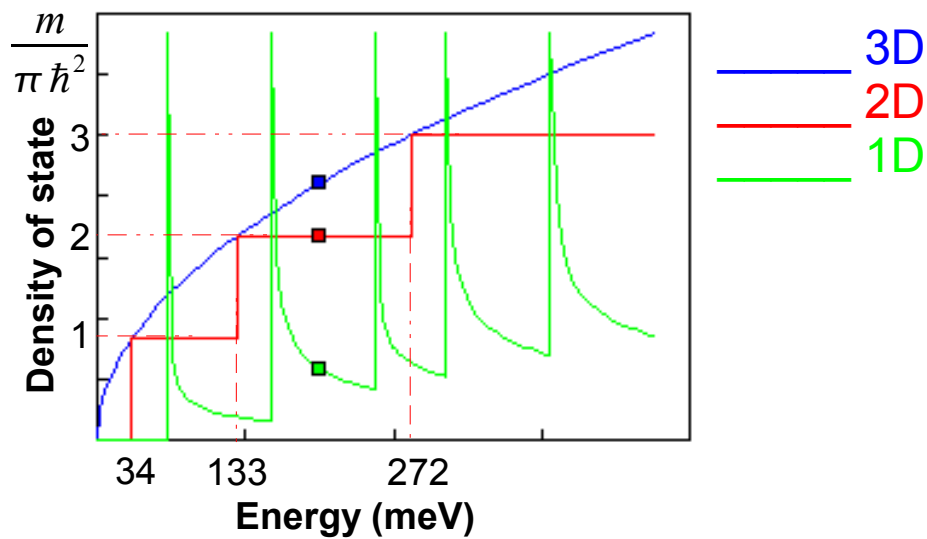

## Heavy hole and Light hole

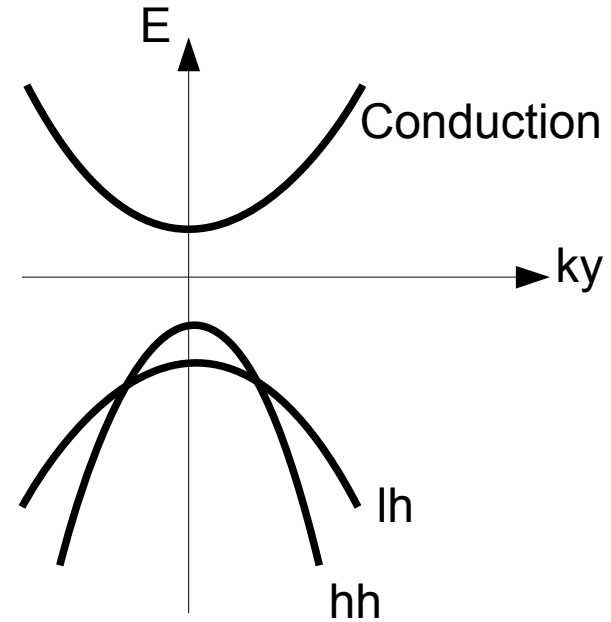
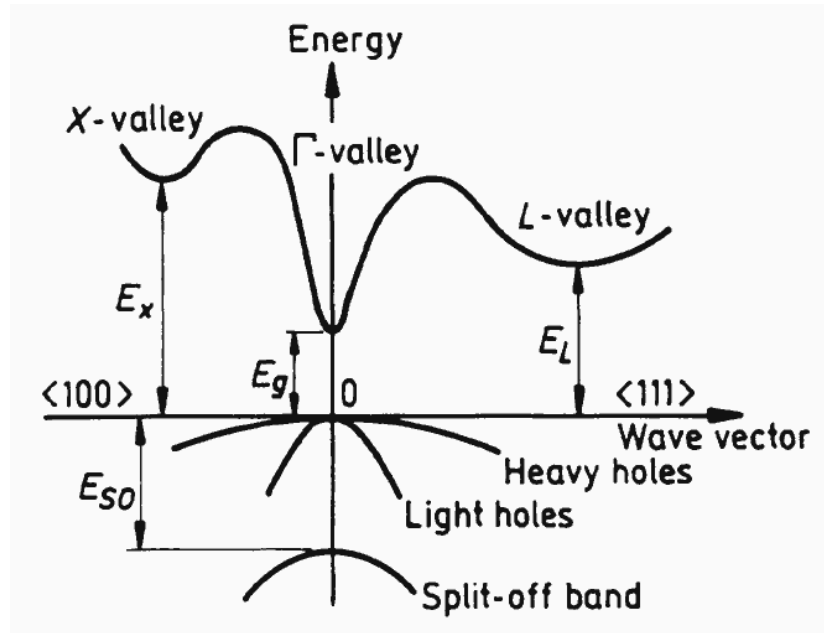

Band structure in Bulk GaAs

$$m_e = 0.064 m_0, m_{lh} = 0.08 m_0, m_{hh} = 0.5 m_0$$

Luttinger Hamiltonian, 
$$H = \frac{\hbar^2}{2m_0} \left( (\gamma_1 + \frac{5}{2}\gamma_2)k^2 - 2\gamma_2(k_x^2 J_x^2 + k_y^2 J_y^2 + k_z^2 J_z^2) - 4\gamma_3 \{k_x, k_y\} \{J_x, J_y + \dots\} \right)$$

For GaAs,  $\gamma_1 = 6.84$ ,  $\gamma_2 = 2.1$ ,  $\gamma_3 = 2.9$  "The Physics of Low-Dimensional Semiconductor" John H. Davies

$$m_{hh} = \frac{m_0}{\gamma_1 - 2\gamma_2}, m_{lh} = \frac{m_0}{\gamma_1 + 2\gamma_2} \text{ along } z \text{ (growth) direction}$$

$$m_{hh} = \frac{m_0}{\gamma_1 + \gamma_2}, m_{lh} = \frac{m_0}{\gamma_1 - \gamma_2} \text{ along } xy \text{ - direction}$$

# Selective spin excitation in Quantum Well

## 3D- Spin +1 excitation

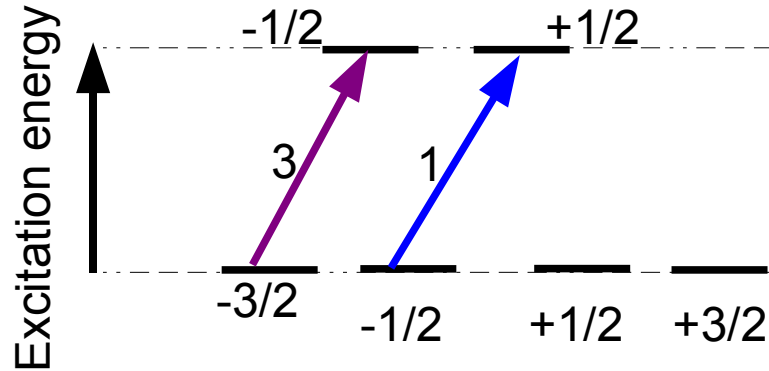

Excited to 3 (-1/2) + 1(+1/2)  
 Maximum polarizability =  $(3-1)/(3+1) = 50\%$

## 2D- Spin +1 excitation

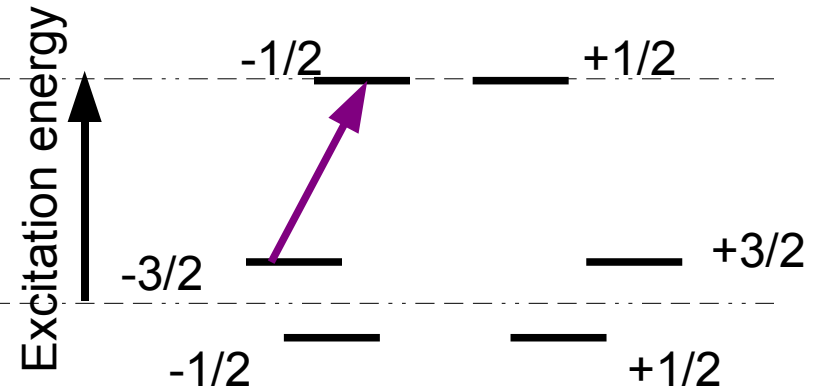

Excite only to -1/2 state  
 Polarization = 100%

# Exciton

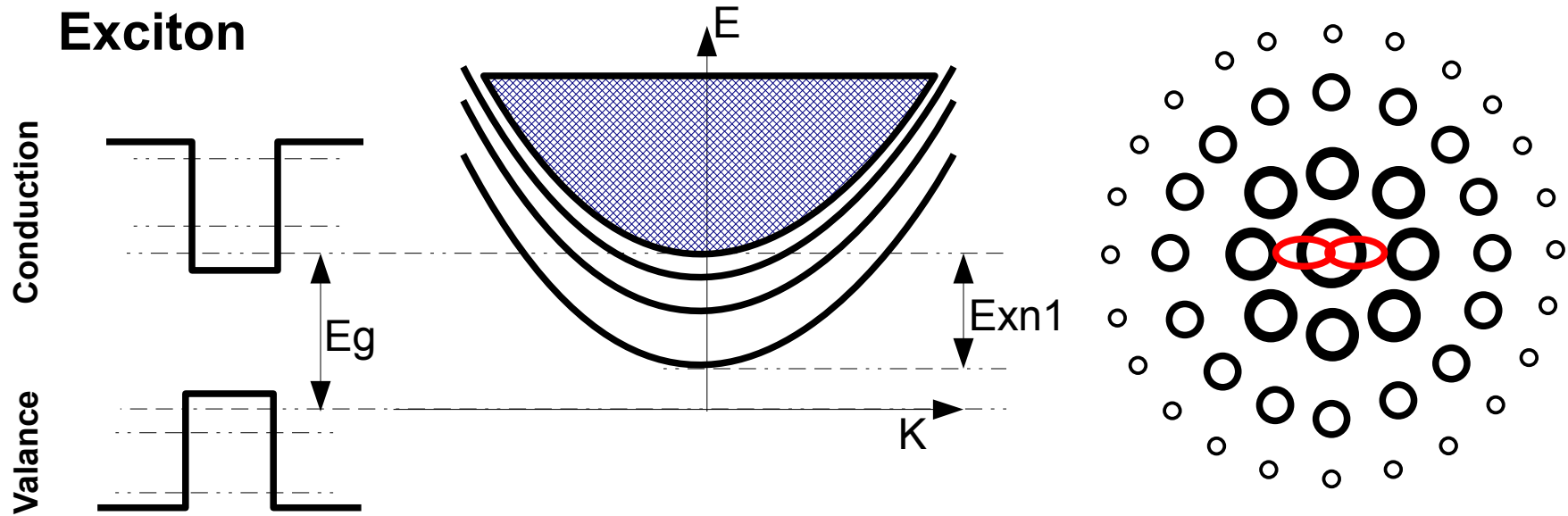

$$E_{xn}^{3D} = E_g - \frac{R_y}{n^2}, \text{ where } R_y = \frac{m_{eff}}{2} \left( \frac{e^2}{4\pi\epsilon_0\epsilon_b\hbar} \right)^2$$

3D\_GaAs , binding energy  $\sim 4.8\text{meV}$

$$E_{xn}^{2D} = E_g - \frac{R_y}{(n-1/2)^2}$$

In 2D, exciton binding energy increases 4 times.

2D\_GaAs, binding energy  $\sim 19.2\text{meV}$

room temperature  $\sim 25\text{meV}$

MOCVD (Metal-organic chemical vapour deposition)

MBE (Molecular-beam epitaxy)

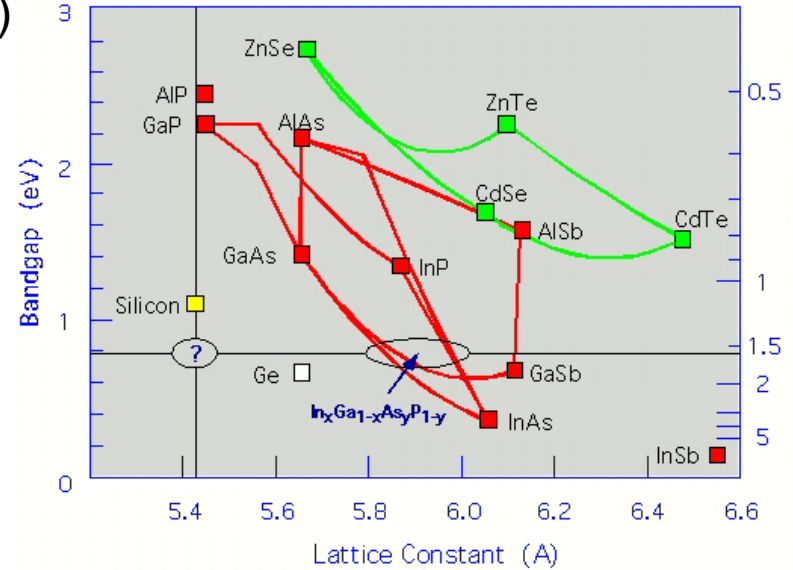
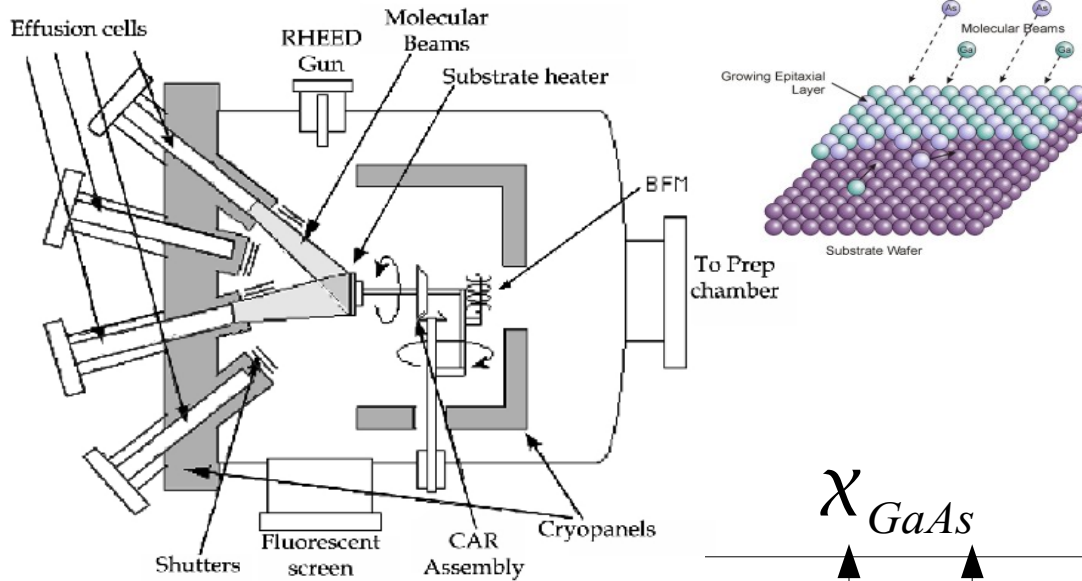

## Anderson's rule

Vacuum level must match.

$$\chi_{GaAs} = 4.07\text{eV}$$

$$\chi_{Al_{0.3}Ga_{0.7}As} = 3.74\text{eV}$$

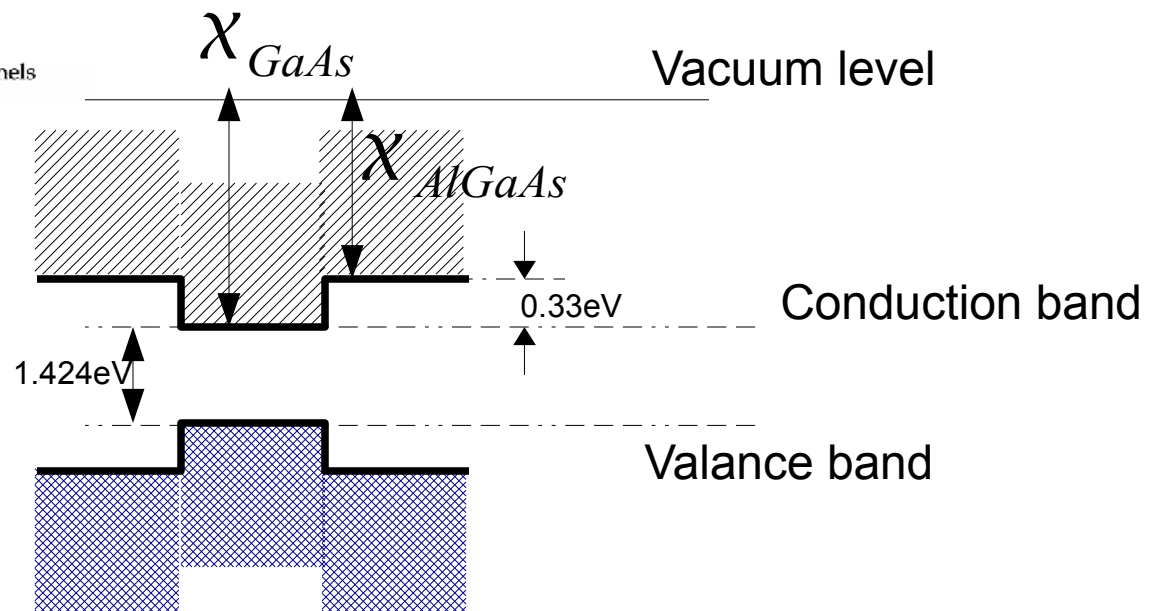

# Spectroscopy (Light-matter interaction)

- Absorption spectroscopy
- Photo-luminescent spectroscopy
- Raman spectroscopy
- 
- 

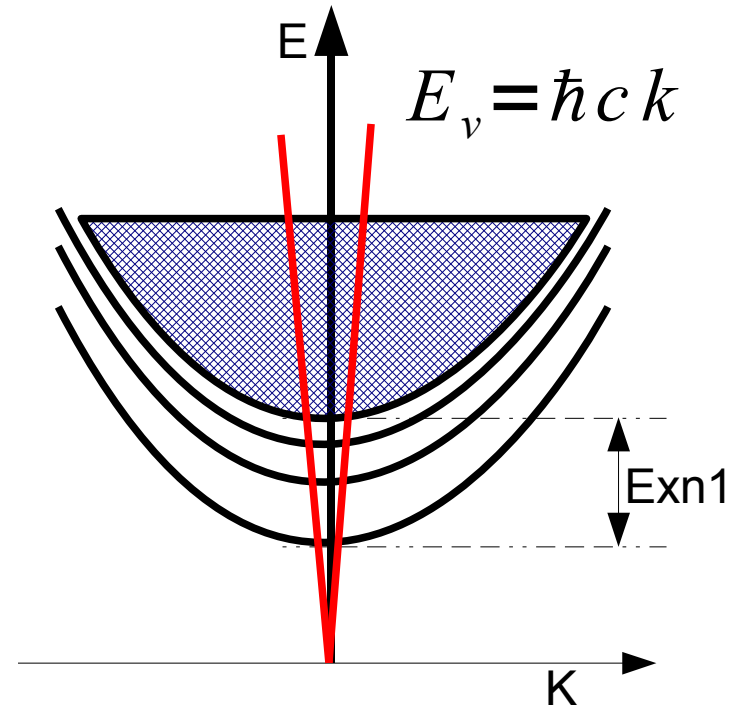

eg. wavelength=800nm excitation at GaAs ( $m_e=0.06 m_0$ )  
parabolic approximation  $\rightarrow \Delta E=0.6 \text{ meV}$



# Absorption spectroscopy



OPTICAL PROPERTIES OF THIN HETEROSTRUCTURES

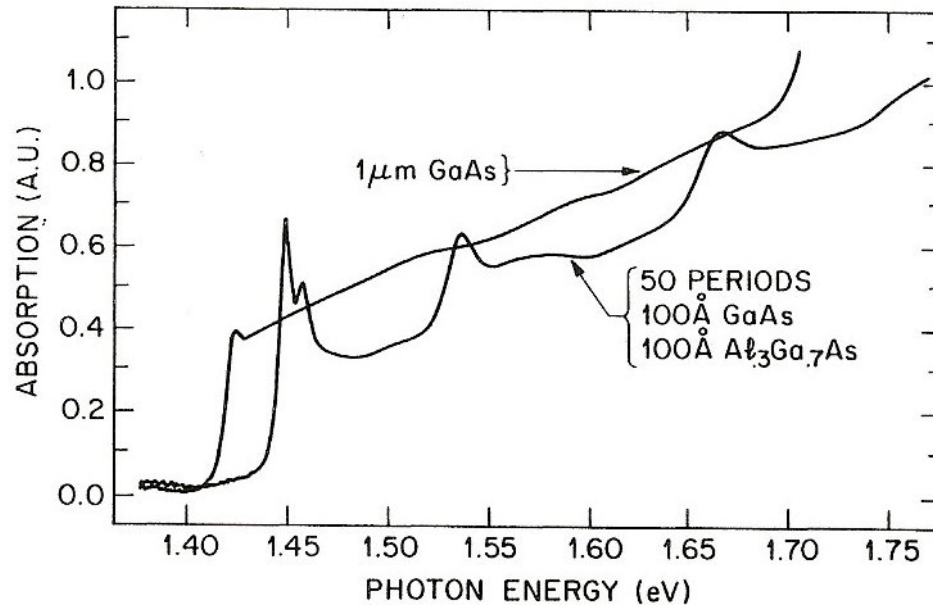

GaAs / AlGaAs QW absorption measurement

# Application and outlook

- Quantum well laser
- Electron spin control
- Room temperature exciton applications
- Lattice mismatch problem and strain

Thank you

MOCVD (Metal-organic chemical vapour deposition)

MBE (Molecular-beam epitaxy)

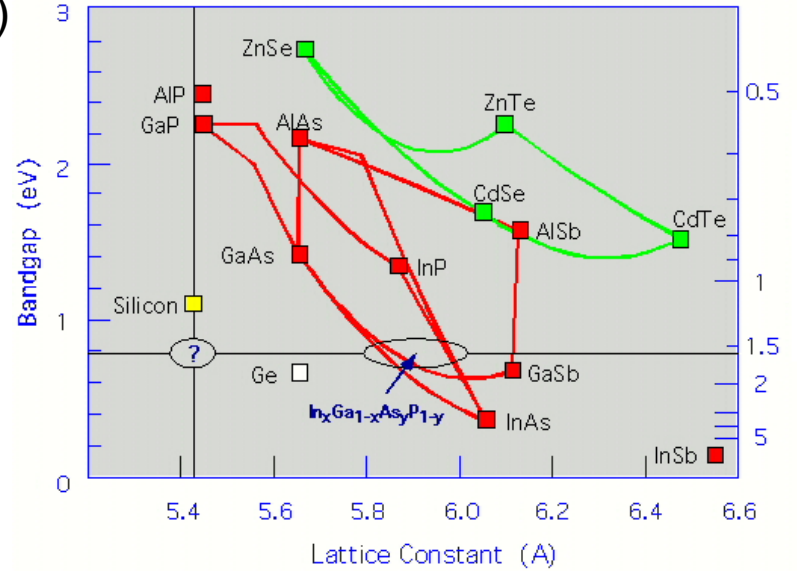
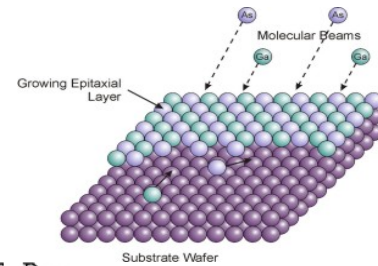
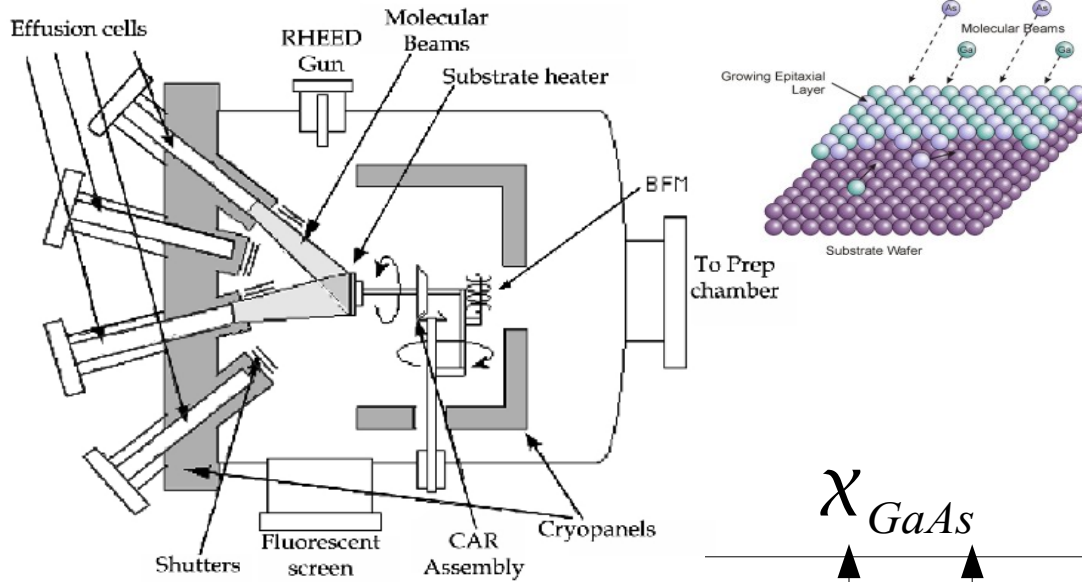

## Anderson's rule

Vacuum level must match.

$$\chi_{GaAs} = 4.07\text{eV}$$

$$\chi_{Al_{0.3}Ga_{0.7}As} = 3.74\text{eV}$$

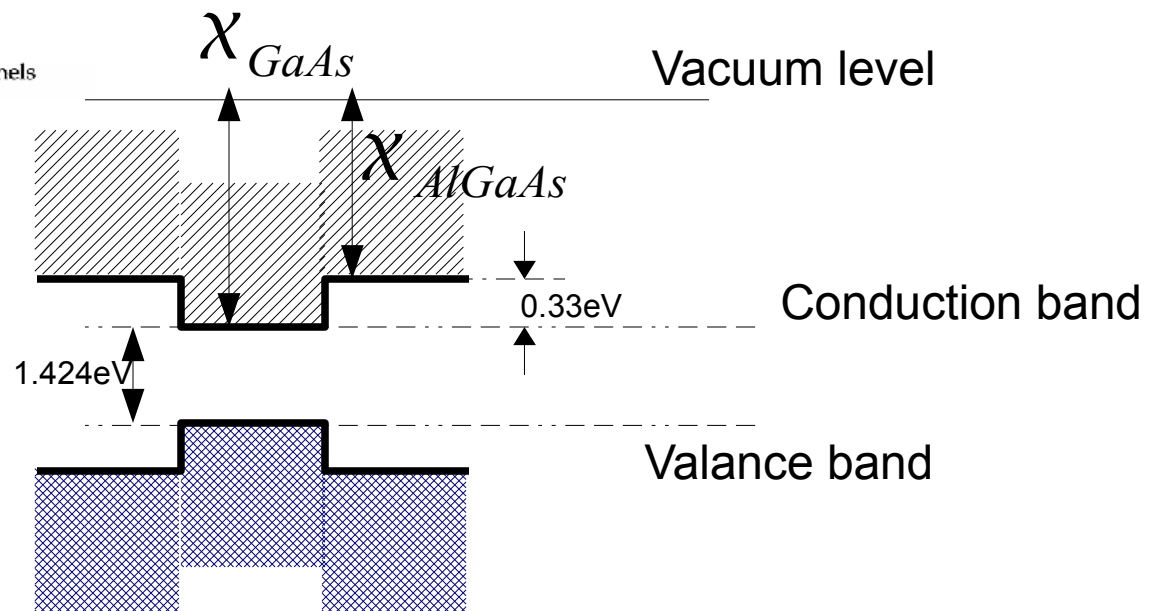

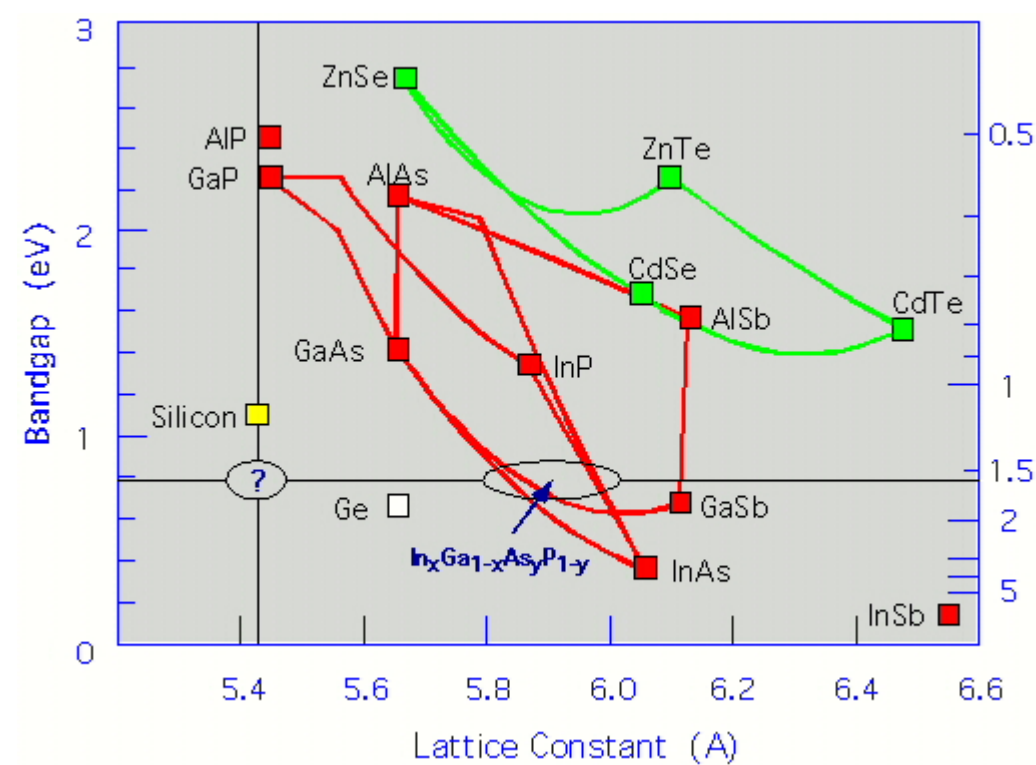

Lattice constant must match to avoid strain in the structure.

## Anderson's rule

Vacuum level must match.

$$\chi_{GaAs} = 4.07\text{eV}$$

$$\chi_{Al_{0.3}Ga_{0.7}As} = 3.74\text{eV}$$

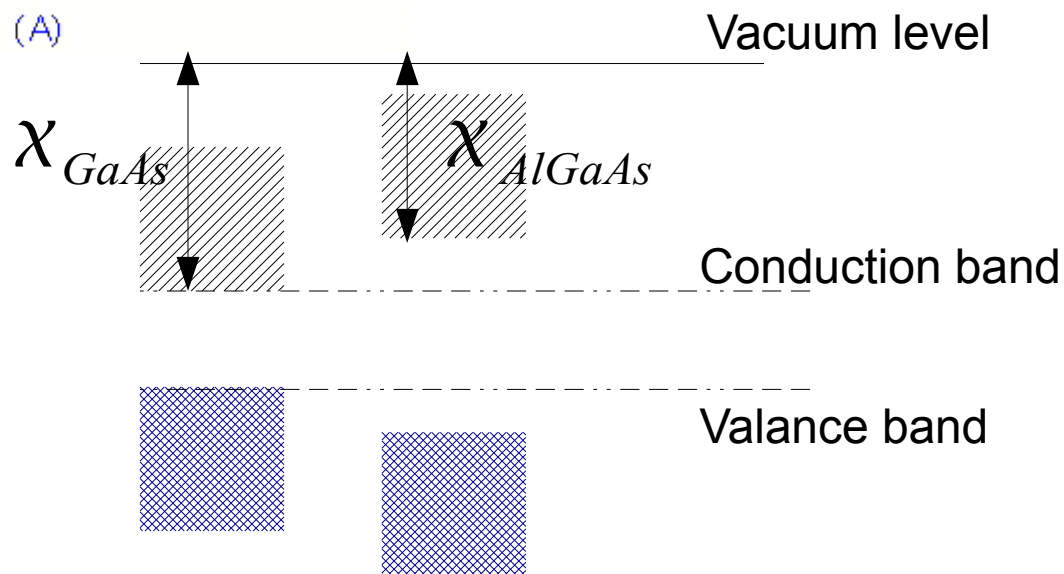

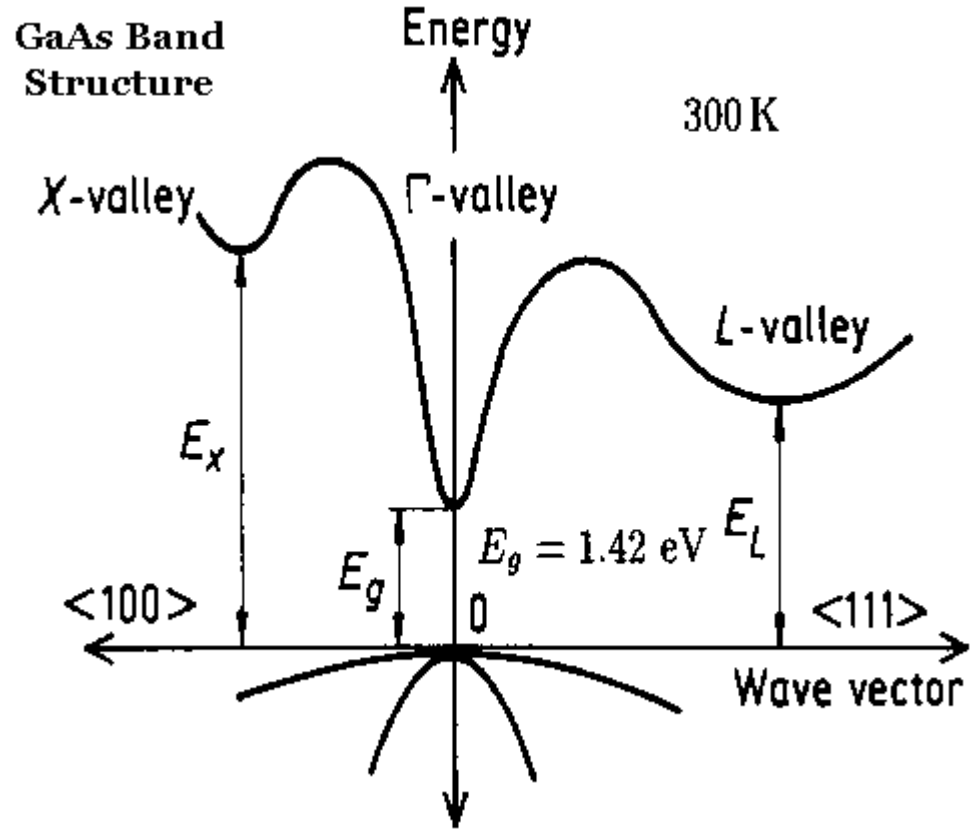
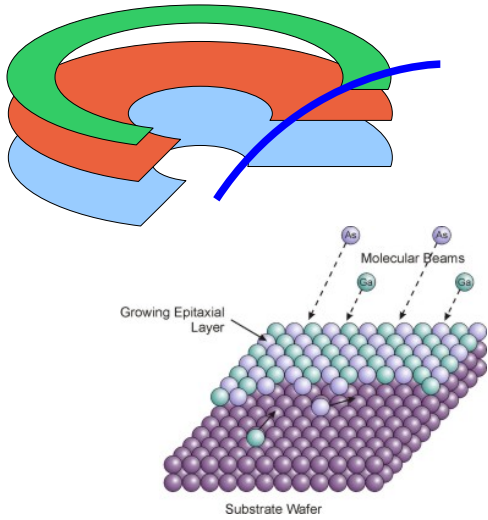

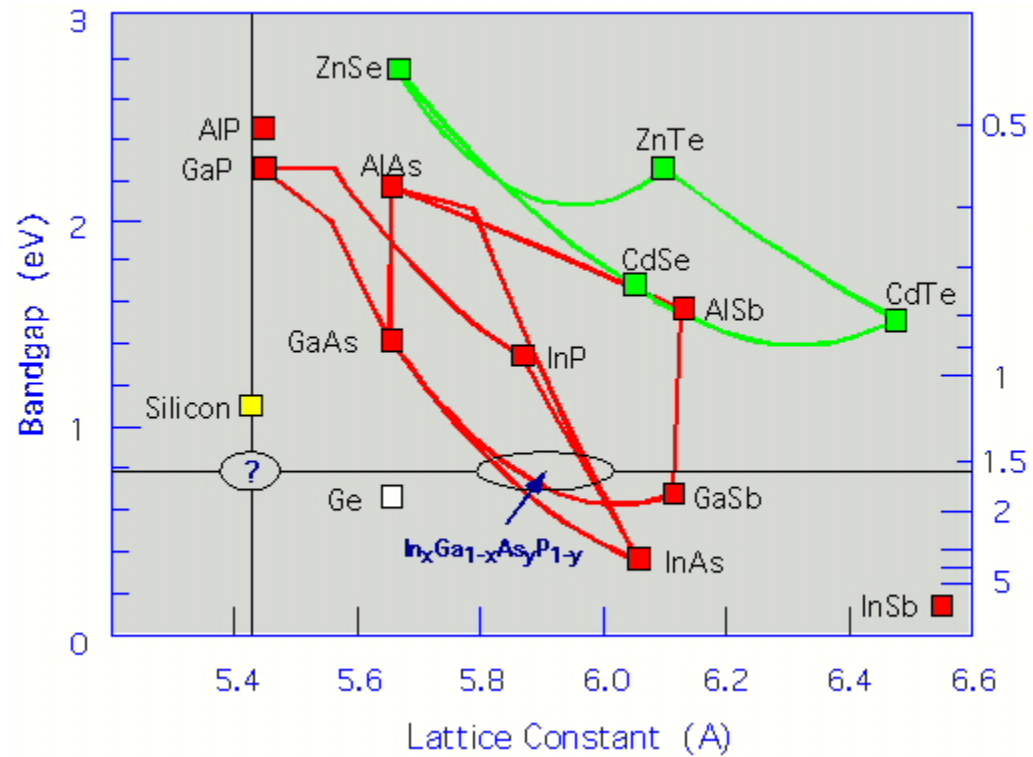

## Exciton in 3D

$$a_0 = 4\pi\epsilon_0\epsilon_b\hbar^2/e^2 m_0 m_{eh}$$

$$1/m_{eh} = 1/m_e + 1/m_h$$

$$E_n = E_g - \frac{R_{eh}}{n^2} \quad R_{eh} = \frac{m_{eh}}{2} \left( \frac{e^2}{4\pi\epsilon_0\epsilon_b\hbar} \right)$$





$$-\frac{\hbar^2}{2m} \frac{d^2\psi}{dx^2} + V(x)\psi = E\psi \quad (1)$$

$$\frac{\sqrt{2m(V-E)}}{\hbar} = \begin{cases} k \tan(ka) \\ -k \cot(ka) \end{cases}$$

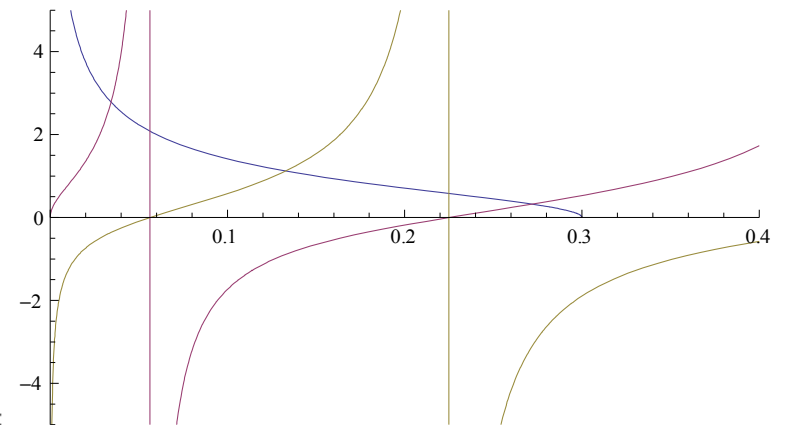
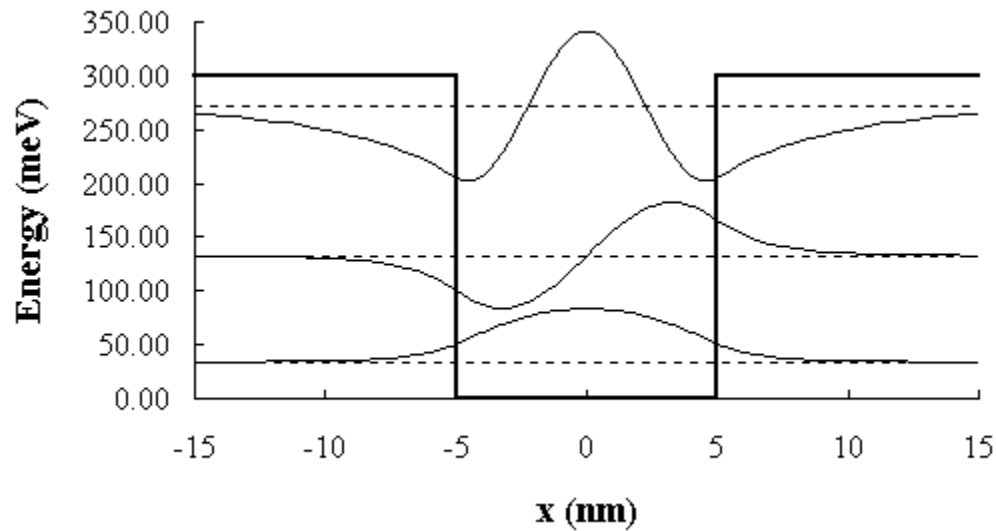

$m_e = 0.067 m_0$  in GaAs

$\Delta E_c \sim 0.2 \sim 0.3$  eV for AlGaAs and GaAs

$$E_{bound} = E_{GaAs} + \frac{\hbar^2 \pi^2 n^2}{2 m_e a^2}$$

band gap of GaAs = 1.424 eV (300K)  $\sim$  870nm

## Useful data

room temp X-ionization,  $t \sim 300 \pm 100$  fs (GaAs QW) < PRL 54, 1306 1985 >

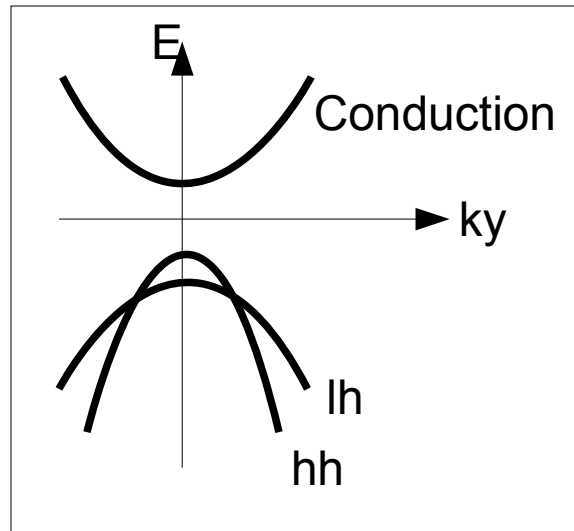

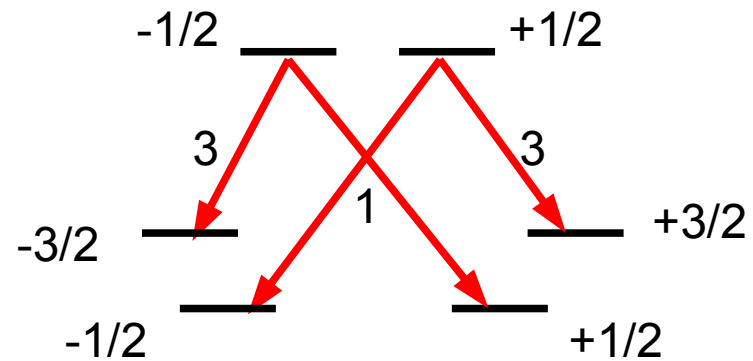
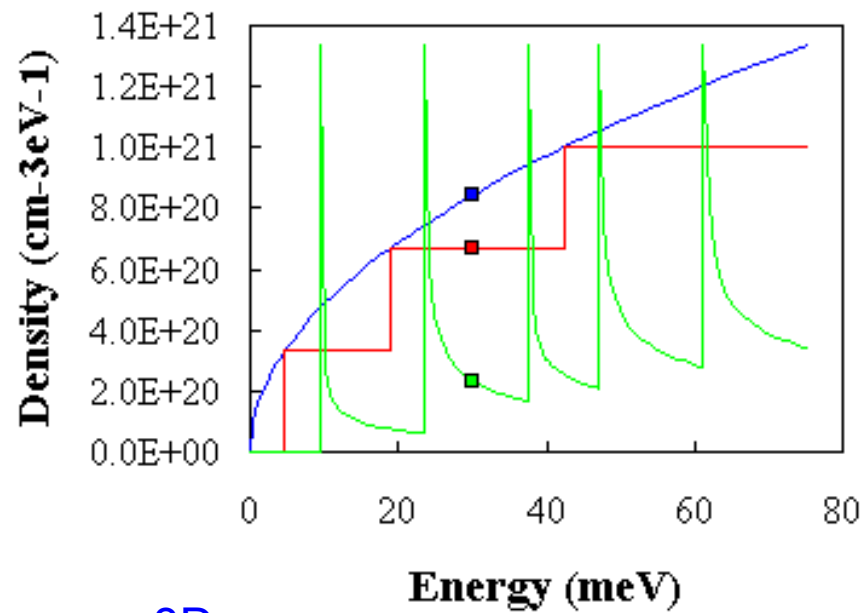

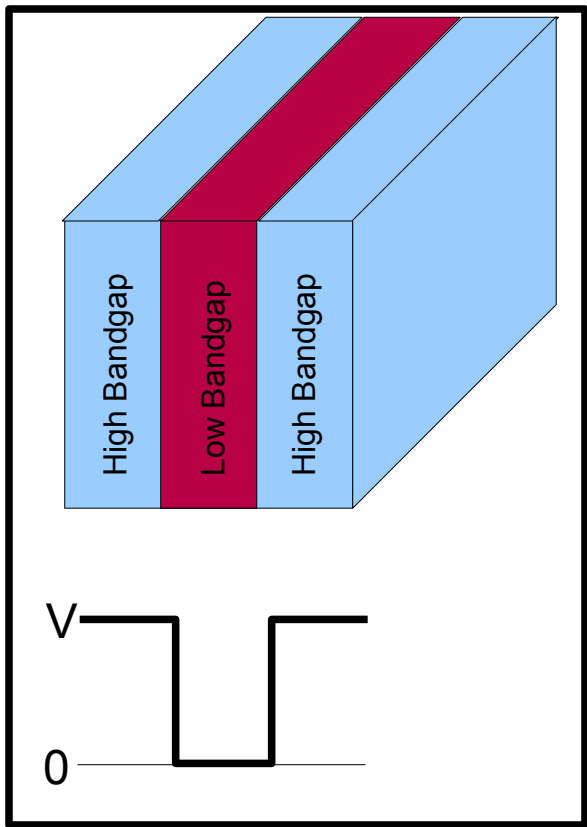

$$\frac{m}{\pi \hbar^2}$$

Conduction

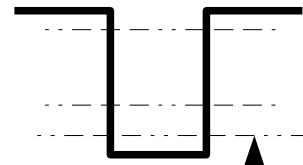

Valance

