

# Stern Gerlach Experiment

how spins behave in magnetic fields

# Basic elements of Stern-Gerlach Experiment

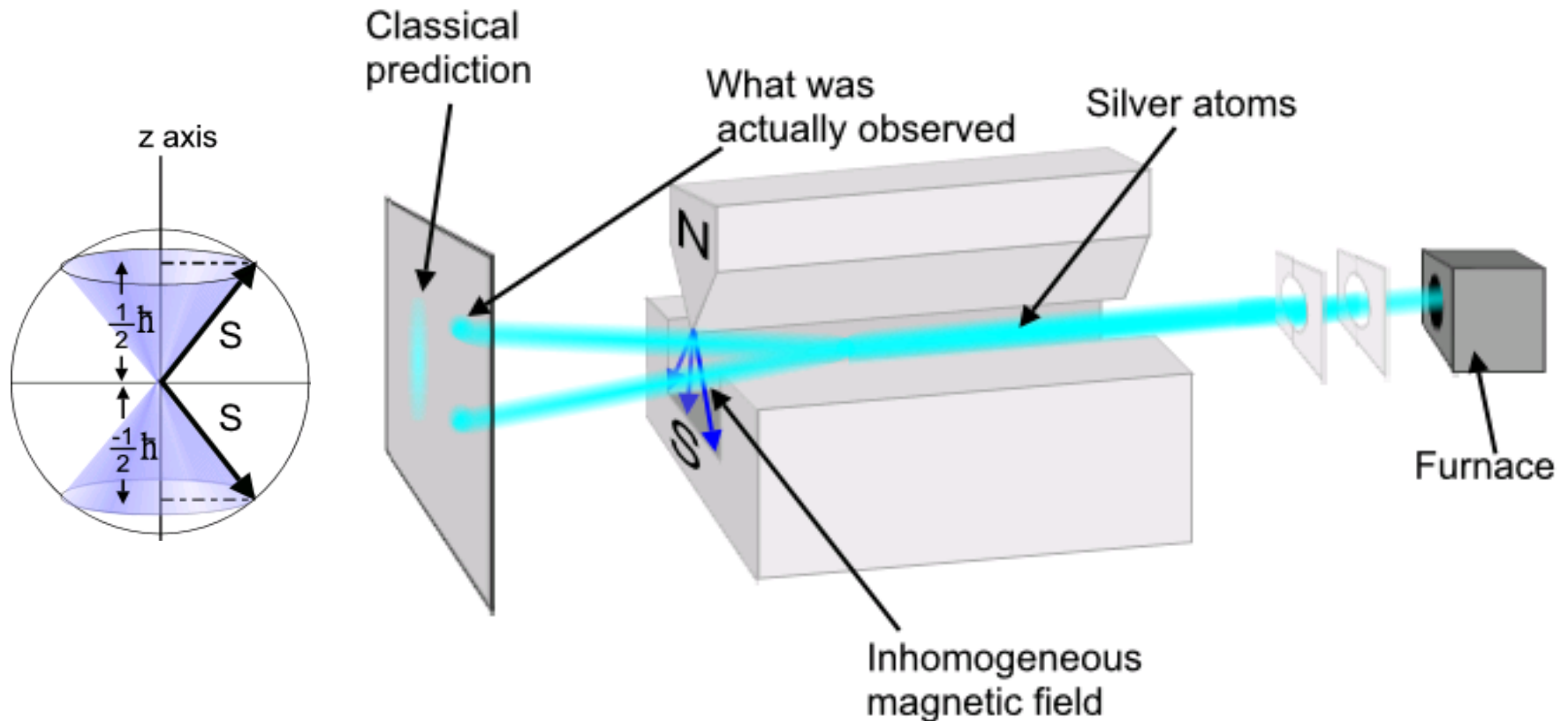

[http://en.wikipedia.org/wiki/File:Stern-Gerlach\\_experiment.PNG](http://en.wikipedia.org/wiki/File:Stern-Gerlach_experiment.PNG)

# Stern-Gerlach Experiment - animation

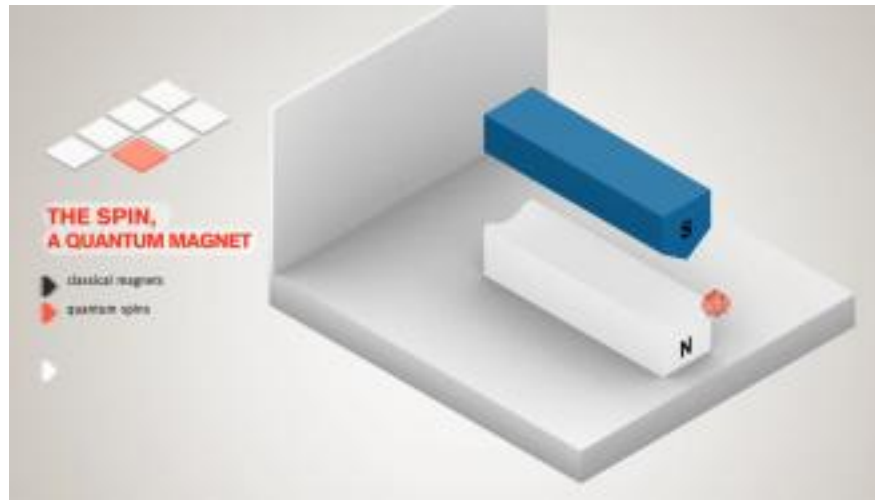

[http://upload.wikimedia.org/wikipedia/commons/9/9e/  
Quantum\\_spin\\_and\\_the\\_Stern-Gerlach\\_experiment.ogv](http://upload.wikimedia.org/wikipedia/commons/9/9e/Quantum_spin_and_the_Stern-Gerlach_experiment.ogv)

# Spin is quantized

- For electrons (& other fermions), spin can only take on two values: up  $\uparrow$  or down  $\downarrow$ .
- What's so special about the z-axis?
  - Answer: nothing.
- Can measure spin along any axis, will always find spin either aligned or anti-aligned with the axis you measure along.
- Just like position and momentum, spin along orthogonal axes obeys Heisenberg uncertainty principle:  $s_x s_z \geq \hbar/2$ ;  $s_y s_z \geq \hbar/2$ ;  $s_x s_y \geq \hbar/2$
- State of definite spin in x-direction --> 50/50 superposition of up and down in z-direction.

## How do we know? Stern-Gerlach Experiment

Put atoms in inhomogeneous magnetic field pointing in z direction – split in two groups – spin up and spin down

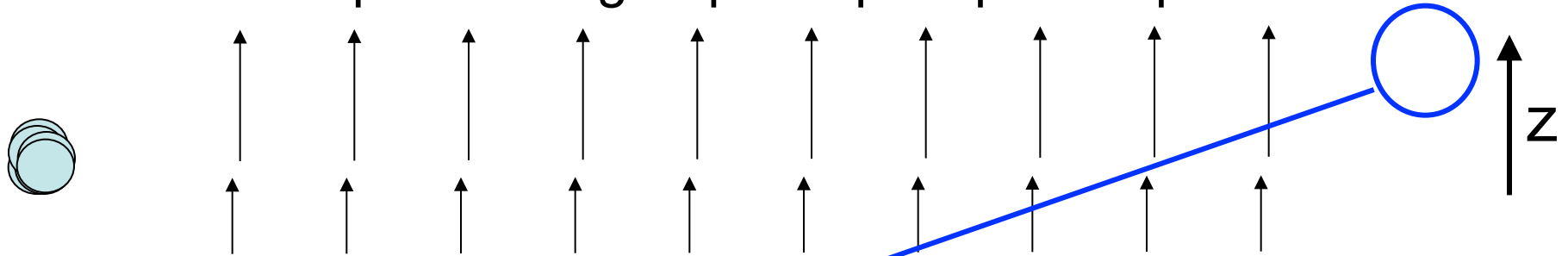

What if I take just atoms that went up, and send them through another, identical magnetic field – What happens?

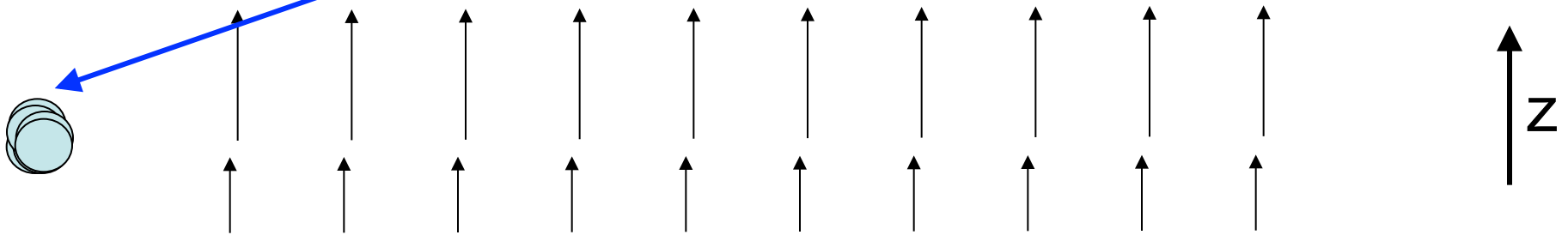

- Half go up (+z), half go down (-z)
- All go up (+z)
- All go down (-z)
- Range of paths all smeared out

Second Experiment: What if I take just atoms that went up, and send them through a magnetic field pointed in the x direction – perpendicular to first field (pointing into the screen)?

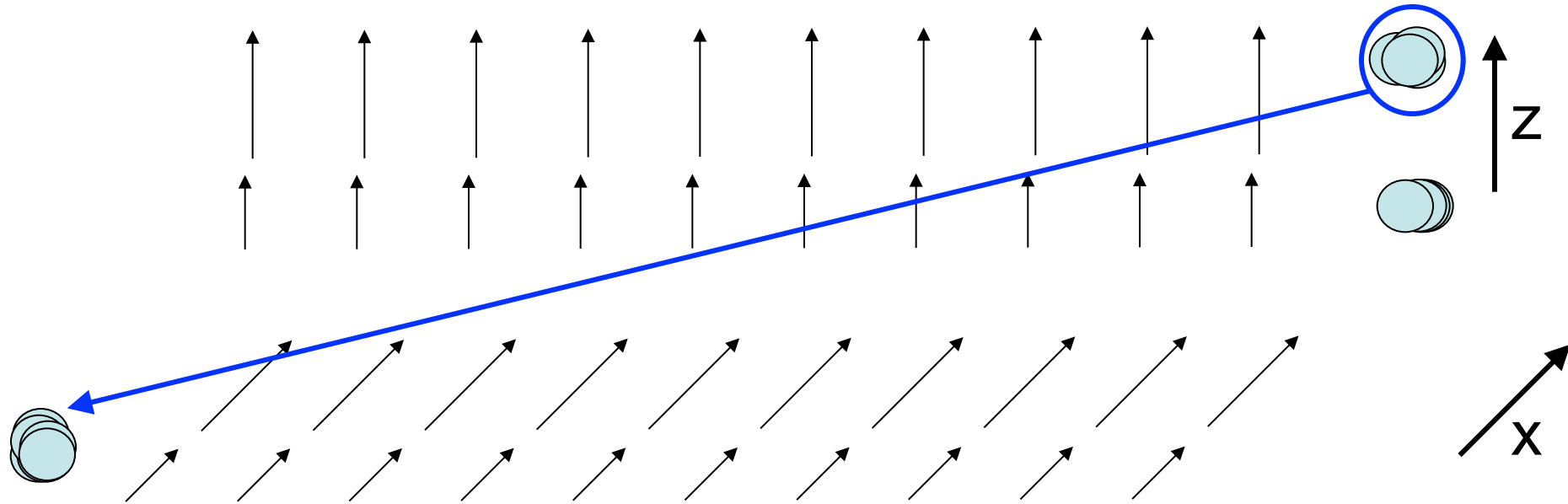

- Half go into the screen (+x), half go out of the screen (-x)
- All go into the screen (+x)
- All go straight (no deflection)
- Range of paths all smeared out
- All go up (+z)

Third Experiment: Take just the atoms that went in  $+x$  direction in second experiment, and send them through a third magnetic field, pointed in the  $z$  direction?

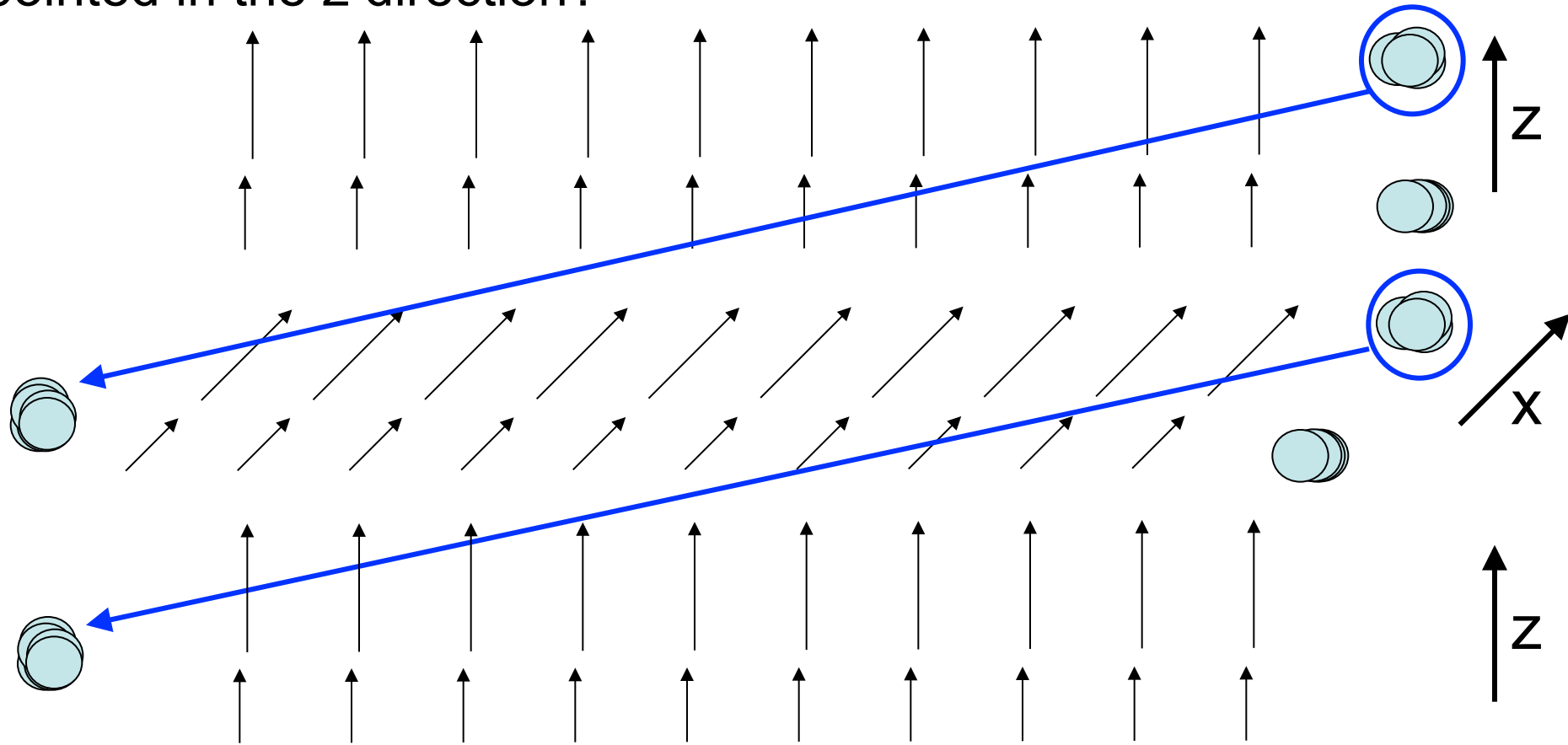

- Half go up ( $+z$ ), half go down ( $-z$ ).
- All go up ( $+z$ )
- All go down ( $-z$ )
- Range of paths all smeared out.

# Frank-Hertz Experiment

Applet –

<http://phys.educ.ksu.edu/vqm/free/>

FranckHertz.html

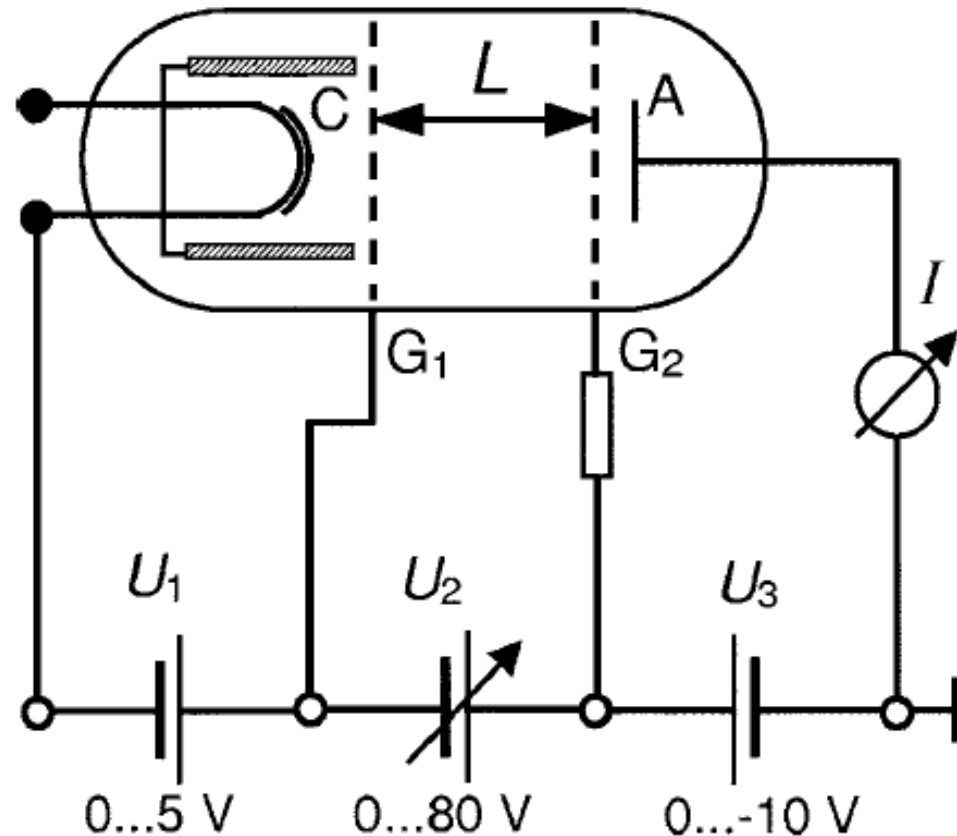
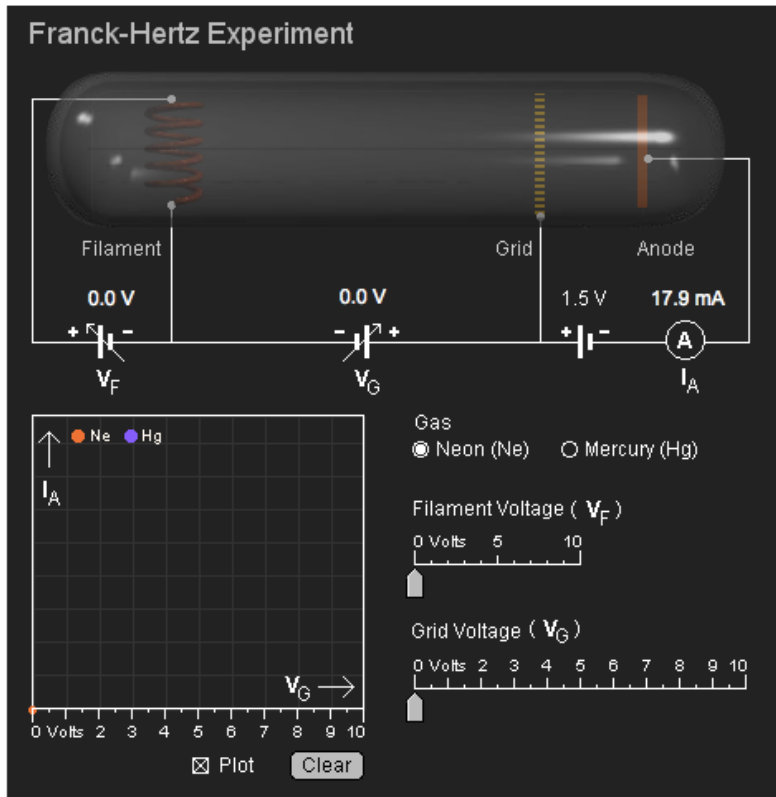

Fig. 1. Schematic diagram of the Franck-Hertz experiment.

## New features of the Franck-Hertz experiment

Gerald Rapior, Klaus Sengstock, and Valery Baev<sup>a)</sup>

*Institut für Laser-Physik, Universität Hamburg, Luruper Chaussee 149, 22761 Hamburg, Germany*

*American Journal of Physics* **74**, 423 (2006); doi: 10.1119/1.2174033



# Frank-Hertz Experiment

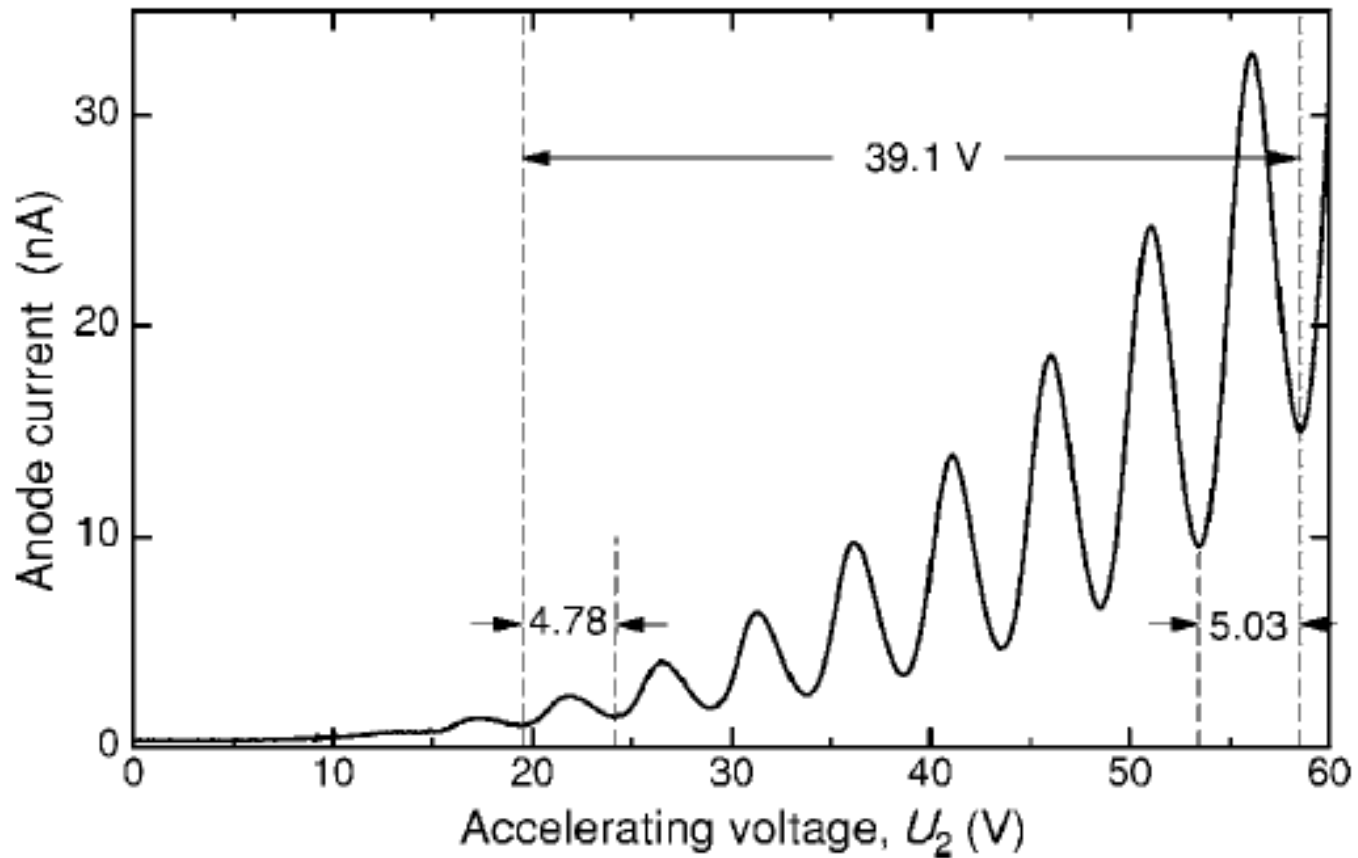

Fig. 3. Typical Franck-Hertz curve recorded with Hg tube at 170 °C.

# Hg energy levels

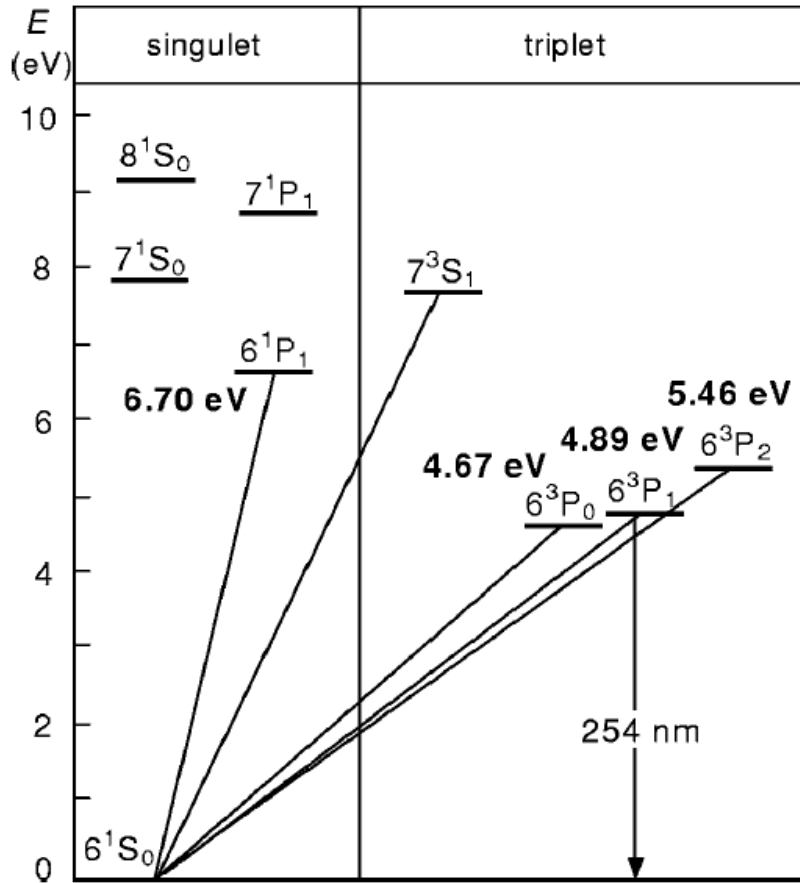

Fig. 2. Lowest energy levels in Hg (Ref. 10).

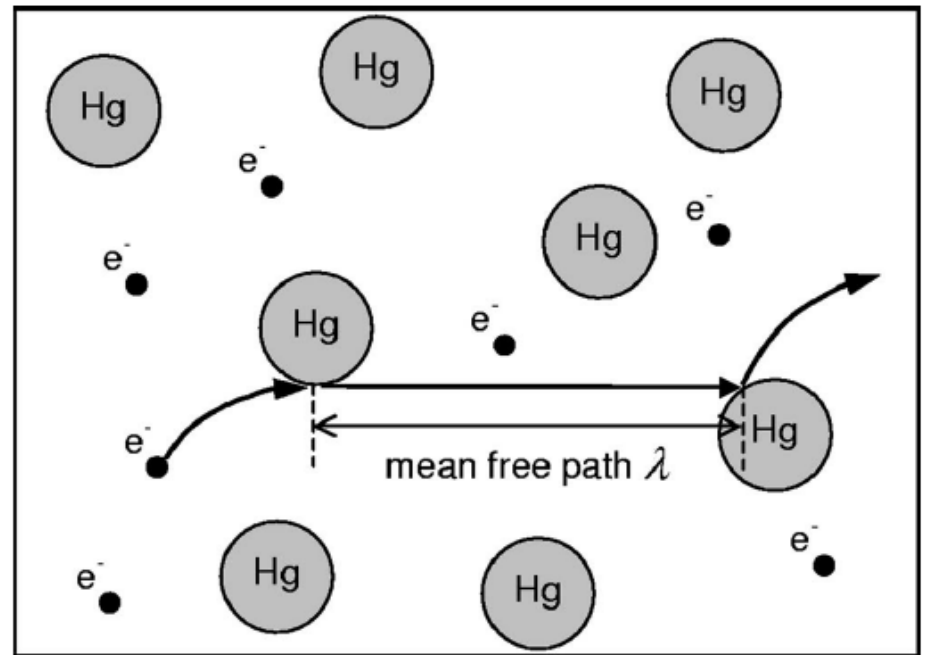

Fig. 5. Schematic of the energy transfer from electrons to atoms.