

Helping Customers Innovate, Improve & Grow



Features

*Reflow Process Compatible
Surface Mount Package
Low Phase Noise
Build in PLL-Circuit*

Typical Applications

Base Stations

Previous Vectron Model Number	C3430
Output Frequency Range	10 MHz – 700 MHz
Standard Frequencies	10; 25; 26; 39.3216; 52; 56; 61.44; 77.76; 104; 122.88 MHz 153.6; 155.52; 160; 184.32; 311.04; 491.52; 622.08 MHz

Reference Frequency

Parameter	Min	Typ	Max	Units	Condition
Input frequency	1		300	MHz	± 2 ppm
Standard input frequencies		10 13 26 32,768		MHz MHz MHz MHz	Options ⁵
Signal	HCMOS				
Reference Level	0.5		4	V _{pp}	
Reference Input Impedance	2			kΩ	

Reference Frequency

Parameter	Min	Typ	Max	Units	Condition
Signal	PECL				LVPECL
Reference Level Min	1.355		1.68	V	
Reference Level Max	2.155		2.42	V	
Reference Input Impedance		50		Ω	
Signal	LVDS				LVDS
Reference Level Min	-0.45		-0.25	V	
Reference Level Max	0.25		0.45	V	
Reference Input Impedance		100		Ω	

Output Frequency

Parameter	Min	Typ	Max	Units	Condition
Output frequency	10		700	MHz	
Signal	HCMOS				@ 15 pF 10 to 90 % @ Vs/2
Load		15.0		pF	
Rise and Fall time			5	ns	
Duty cycle	40		60	%	
Signal	PECL				Vs - 2V 20 to 80 %
Load		50		Ω	
Rise and Fall time			1	ns	
Duty cycle	45		55	%	
Signal	LVDS				10 to 90 %
Load		100		Ω	
Rise and Fall time			1	ns	
Duty cycle	40		60	%	

Supply Voltage (Vs)

Parameter	Min	Typ	Max	Units	Condition
Supply voltage [Standard]	3.135	3.3	3.465	VDC	
Current consumption			50	mA	steady state @ +25°C & 3.3VDC

Additional Parameters

Parameter	Min	Typ	Max	Units	Condition
Phase Noise ³		-95		dBc/Hz	10 Hz @ 10 MHz
		-125		dBc/Hz	100 Hz HCMOS
		-142		dBc/Hz	1 kHz
		-155		dBc/Hz	10 kHz
		-160		dBc/Hz	100 kHz
Jitter		0.7		Ps RMS	@ 10Hz .. 100kHz

Additional Parameters

Parameter	Min	Typ	Max	Units	Conditions
Phase Noise ³		-75		dBc/Hz	10 Hz @ 311.04 MHz
		-105		dBc/Hz	100 Hz PECL
		-130		dBc/Hz	1 kHz
		-140		dBc/Hz	10 kHz
		-142		dBc/Hz	100 kHz
Jitter		0.2		Ps RMS	@ 12kHz .. 20MHz
VCXO Control PIN 7	0,5		2,5	V	
Weight			9	g	
Processing & Packing	Handling & processing note				
Operating temperature range	-20		+70	°C	
Operating temperature range	-30		+85	°C	
Storage temperature range	-55		+125	°C	

Absolute Maximum Ratings

Parameter	Min	Typ	Max	Units	Condition
Supply voltage (Vs)			6.0	V	
Maximum output load @ CMOS			40	pF	

Enclosure

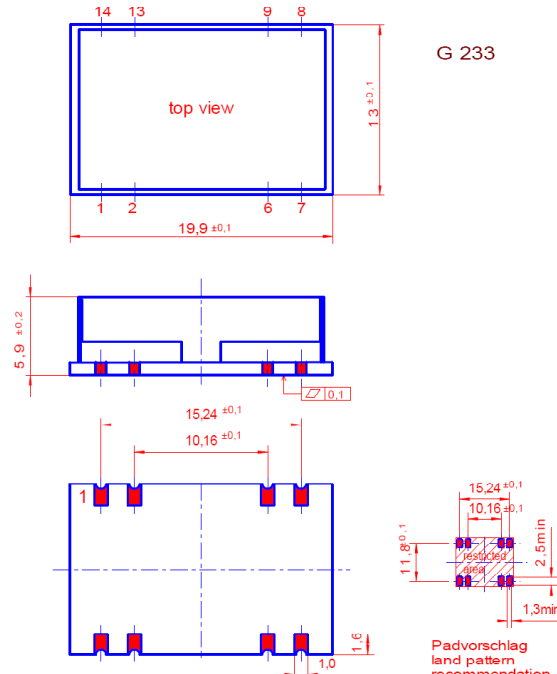
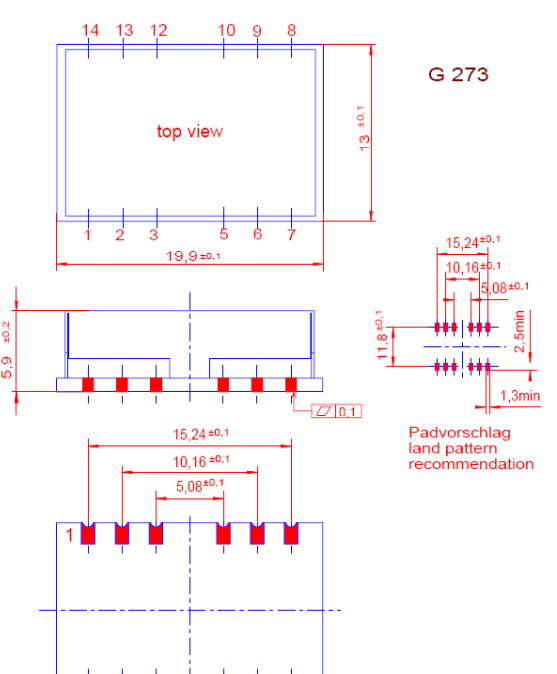
Type G233 "A" Input : Single ended (HCMOS or Sinewave) Output : 1x HCMOS or PECL or LVDS			Type G273 "B" Input : Complementary (PECL or LVDS) Output : 1x PECL or LVDS		
Package Codes :					
Height "H"	Pin Length "L"	Options ⁵	Height "H"	Pin Length "L"	Options ⁵
5.9	NA		5.9	NA	
 <p style="text-align: center;">G 233</p> <p style="text-align: center;">Dimensions : mm</p>			 <p style="text-align: center;">G 273</p> <p style="text-align: center;">Dimensions : mm</p>		
Pin Connections		Description	Pin Connections		Description
1	VCXO Control	Test output of the control voltage for the VCXO Only for modul test or observance	1	VCXO Control	Test output of the control voltage for the VCXO Only for modul test or observance
2	Lock Detector Output	Test output signal for PLL lock detected. High signal □ PLL in lock Low signal □ PLL out of lock Only for modul test or observance	2	Lock Detector Output	Test output signal for PLL lock detected. High signal □ PLL in lock Low signal □ PLL out of lock Only for modul test or observance
6;7	GND	Ground connection. Keep traces physically short and connect immediately to ground plane for best performance	6;7	GND	Ground connection. Keep traces physically short and connect immediately to ground plane for best performance
8	RF-OUT	RF synchronised output.	8	RF-OUT	RF synchronised output.
9	RF-Out complementary / (GND: Single ended input only)	RF synchronised output. Ground connection: Single Ended Input only	9	RF-Out complementary	RF synchronised output.
10			10	GND	
12	Ref. Frequency in	High stable input frequency for synchronisation	12	Ref. Frequency Complementary in	High stable complementary input frequency for synchronisation
13	Ref. Frequency in	High stable input frequency for synchronisation	13	Ref. Frequency in	High stable input frequency for synchronisation
14	Vs	Power supply pin	14	Vs	Power supply pin

Enclosure

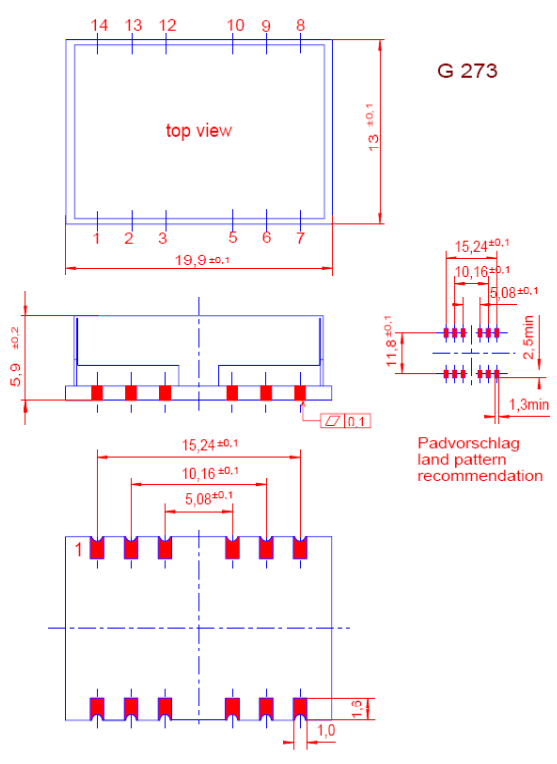
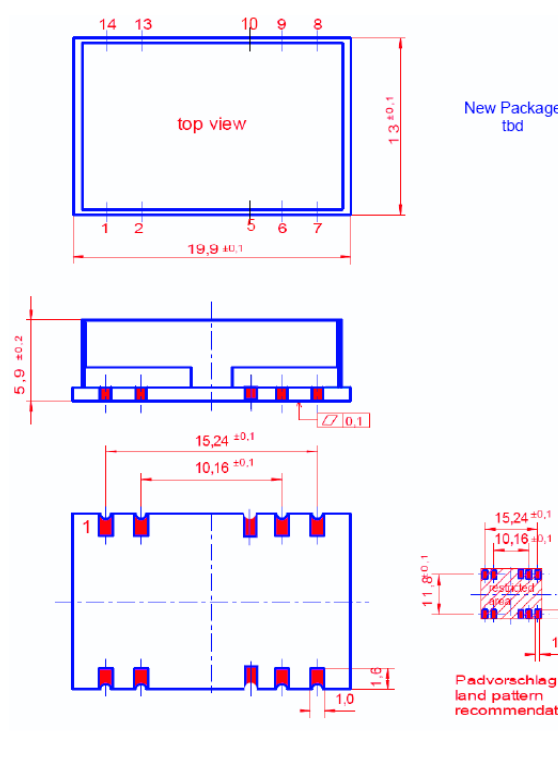
Type G273 "C" Input : Single ended (HCMOS or Sinewave) Output : 2x PECL or LVDS			Type G267 "D" Input : Single ended (HCMOS or Sinewave) Output : 4x HCMOS (same frequency)		
Package Codes :					
Height "H"	Pin Length "L"	Options ⁵	Height "H"	Pin Length "L"	Options ⁵
5.9	NA		5.9	NA	
 <p style="text-align: center;">G 273</p> <p style="text-align: center;">Dimensions : mm</p>			 <p style="text-align: center;">New Package tbd</p> <p style="text-align: center;">Dimensions : mm</p>		
Pin Connections		Description	Pin Connections		Description
1	VCXO Control	Test output of the control voltage for the VCXO Only for modul test or observance	1	VCXO Control	Test output of the control voltage for the VCXO Only for modul test or observance
2	Lock Detector Output	Test output signal for PLL lock detected. High signal □ PLL in lock Low signal □ PLL out of lock Only for modul test or observance	2	Lock Detector Output	Test output signal for PLL lock detected. High signal □ PLL in lock Low signal □ PLL out of lock Only for modul test or observance
3	N.C.				
5	GND		5	RF-OUT 1	4 independent RF synchronised outputs
6	RF-OUT 1	RF output frequency 1	6	GND	Ground connection. Keep traces physically short and connect immediately to ground plane for best performance
7	Compl. RF-OUT 1	Complimentary RF output frequency 1	7	RF-OUT 2	4 independent RF synchronised outputs
8	RF-OUT 2	RF output frequency 2	8	RF-OUT 3	4 independent RF synchronised outputs
9	Compl. RF-OUT 2	Complimentary RF output frequency 2	9	GND	
10	GND		10	RF-OUT 4	4 independent RF synchronised outputs
12	N.C.				
13	Ref. Frequency in	High stable input frequency for synchronisation	13	Ref. Frequency in	High stable input frequency for synchronisation
14	Vs	Power supply pin	14	Vs	Power supply pin

Enclosure

Marking

FX-401
 Frequency
 • AYYWW

Typical Phase Noise and Jitter

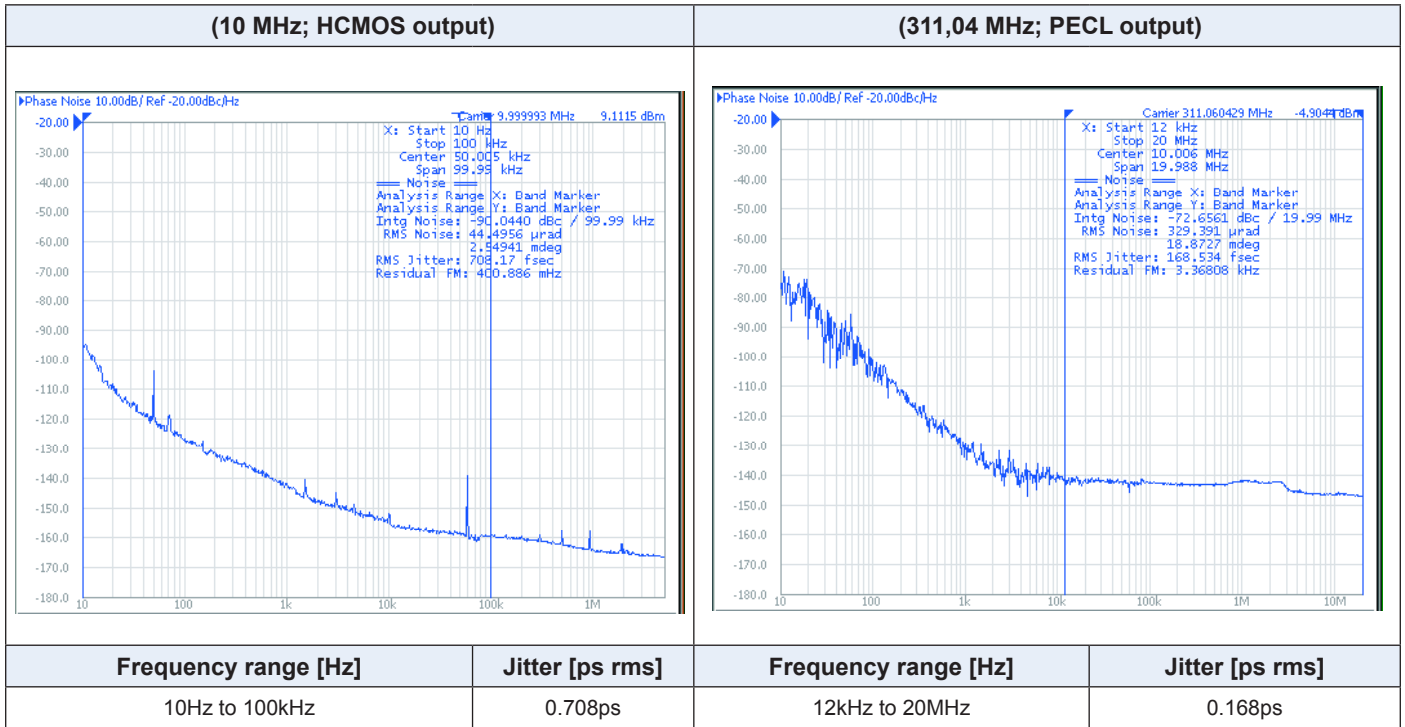

Block Diagramm

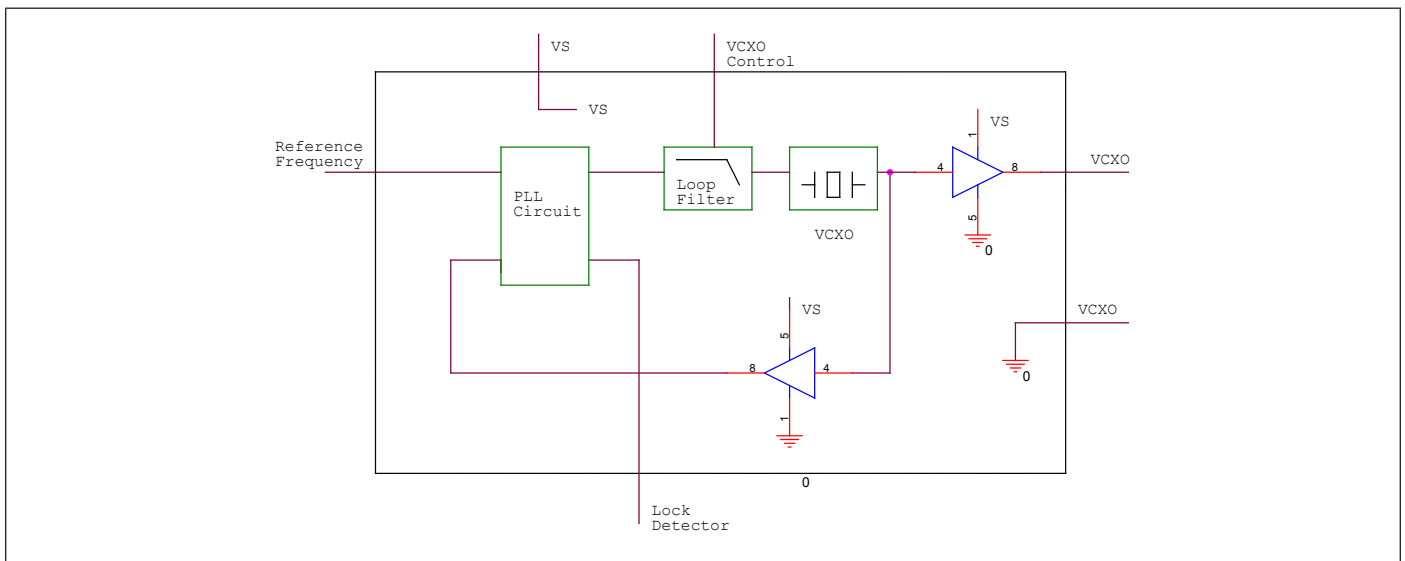

Standard Shipping Methode (For B-Type Enclosure)

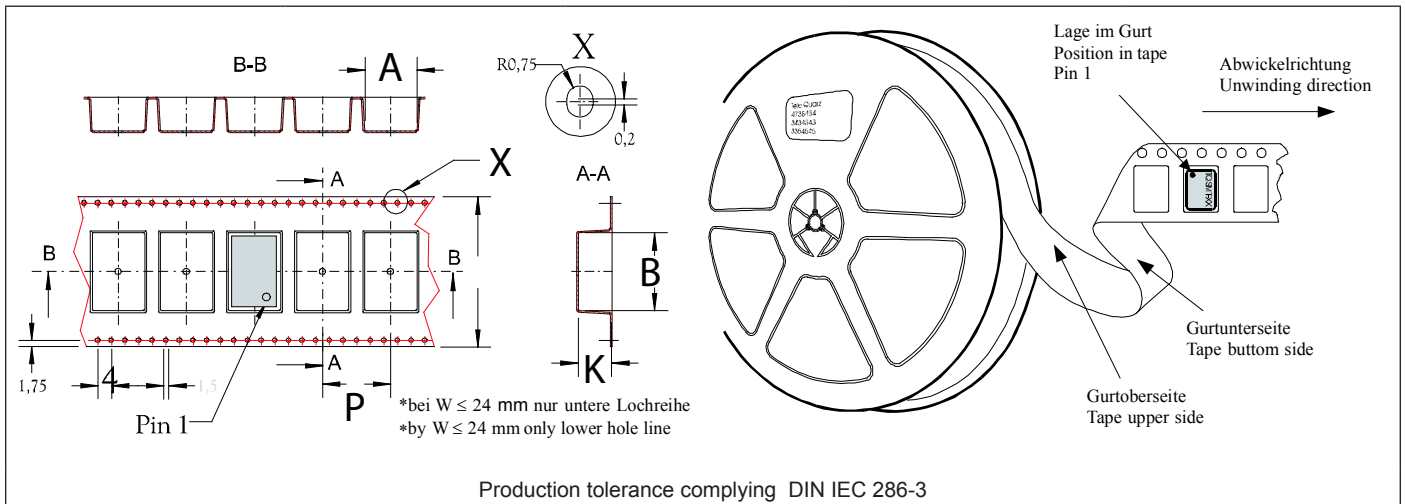

Enclosure Type	Tape width W [mm]	Quantity per meter	Quantity per reel	Dimension P
G194B	tbd	tbd	tbd	tbd

Recommended Reflow Profile

Solderprofile:

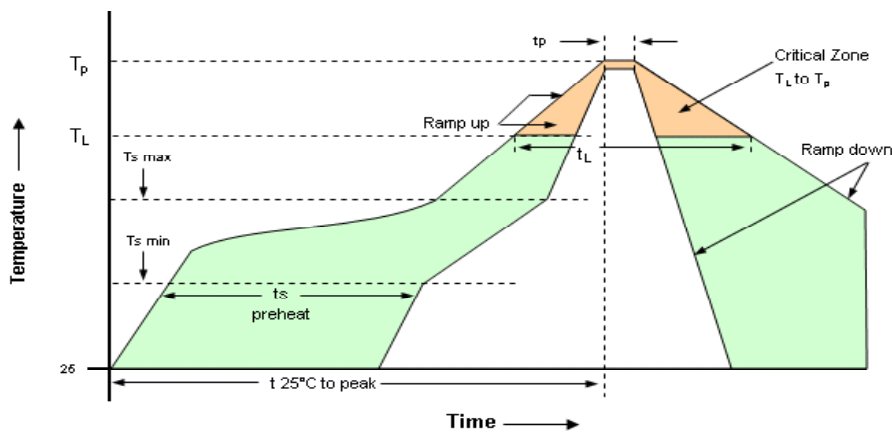

Profile Feature	Pb-Free Assembly/ Sn-Pb Assembly	Profile Feature	Pb-Free Assembly/ Sn-Pb Assembly
Average ramp-up rate (T_L to T_p)	3°C/second max.	Time 25°C to Peak Temperature	8 minutes max.
Preheat -Temperature Min $T_{s_{min}}$ -Temperature Min $T_{s_{max}}$ -Time (min to max)(t_s)	150°C 200°C 60-180 seconds	Time maintained above -Temperature (T_L) -Time (t_L)	217°C 60-150 seconds
$T_{s_{max}}$ to T_L -Ramp-up Rate	3°C/second max		
Time maintained above -Temperature (T_L) -Time (t_L)	217°C 60-150 seconds	Time within 5°C of actual Peak Temperature (t_p)	20-40 seconds
Peak Temperature (T_p)	max 260°C	Ramp-down Rate	6°C/ second max

Note: All temperatures refer to topside of the package, measured on the package body surface.
SMD oscillators must be on the top side of the PCB during the reflow process.

How to order this product:

Use this worksheet to forward the following information to your factory representative:									
Model	Height	-	Supply Voltage Code	RF Output Code	Temperature Range	-	Reference Frequency	-	Output Frequency
FX-401	1	-	E	A	J	-		-	

Height: 1: A 5,9 mm 2: B 5,9 mm 3: C 5,9 mm 4: D 5,9 mm	Supply Voltage Code: E: 3,3 V	RF Output Code: A: HCMOS C: PECL D: LVDS	Temperature Range: H: -30...+85°C J: -20...+70°C
---	----------------------------------	---	--