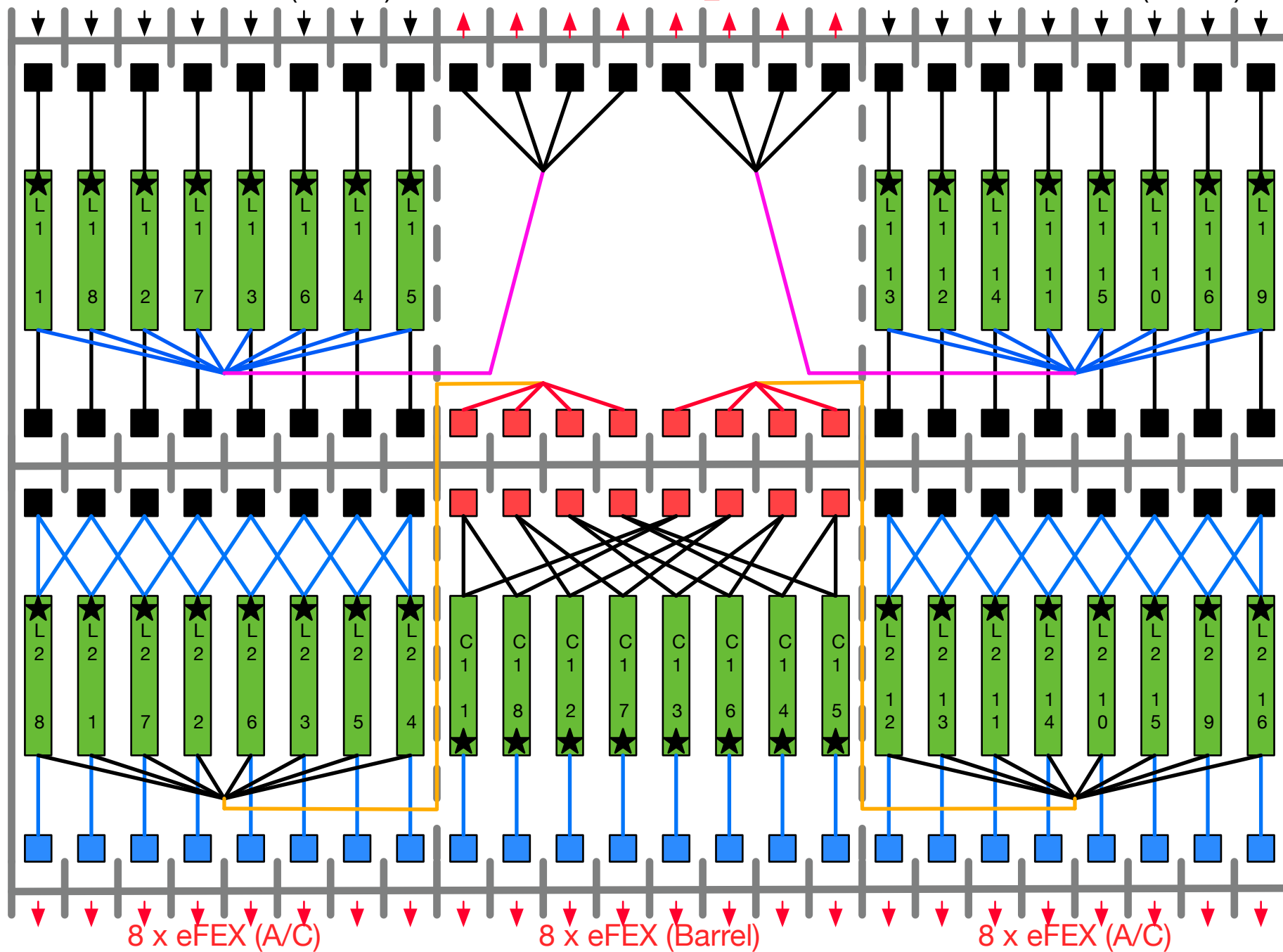

**F**

16 x EMB/EMEC (C-side)

16 x TileFOX\_E/F

16 x EMB/EMEC (A-side)

**B**

8 x eFEX (A/C)

8 x eFEX (Barrel)

8 x eFEX (A/C)

**LArFOX B****Key**

x1

x2

x4

x8

x16

Shuffle  
BoxShort  
SideInput/  
Output

LArFOX B

Outside Box View - Head On

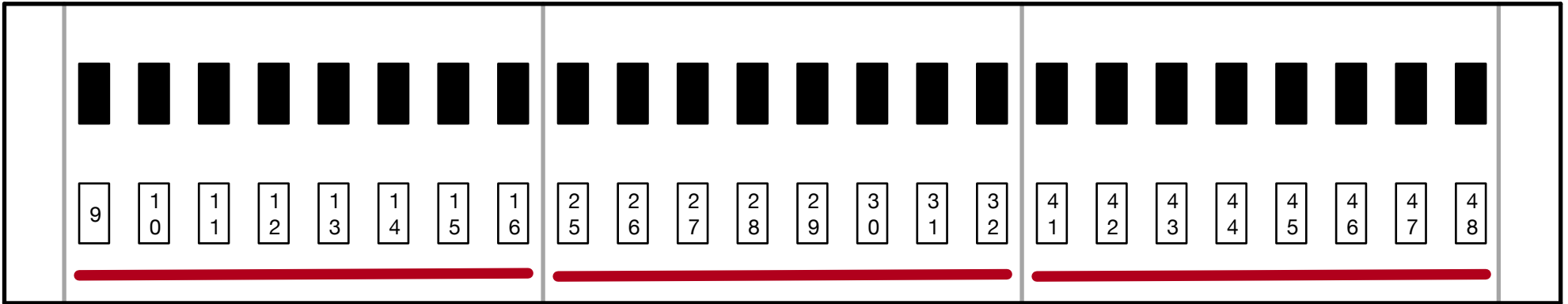
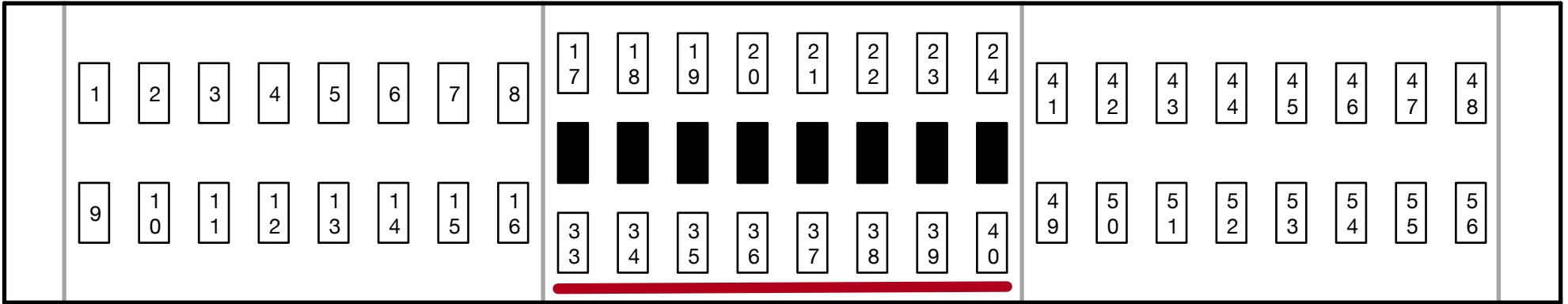

## LArFOX B Front Panel

- |                     |                     |                    |
|---------------------|---------------------|--------------------|
| 1. EE0A1.A L1.9.A   | 17. L1.9.E t42.2.B  | 41. EE0C5.A L1.5.A |
| 2. EE0A8.A L1.16.A  | 18. L1.10.E t42.2.A | 42. EE0C4.A L1.4.A |
| 3. EE0A2.A L1.10.A  | 19. L1.11.E t42.4.B | 43. EE0C6.A L1.6.A |
| 4. EE0A7.A L1.15.A  | 20. L1.12.E t42.4.A | 44. EE0C3.A L1.3.A |
| 5. EE0A3.A L1.11.A  | 21. L1.5.E t42.5.B  | 45. EE0C7.A L1.7.A |
| 6. EE0A6.A L1.14.A  | 22. L1.6.E t42.5.A  | 46. EE0C2.A L1.2.A |
| 7. EE0A4.A L1.12.A  | 23. L1.7.E t42.7.B  | 47. EE0C8.A L1.8.A |
| 8. EE0A5.A L1.13.A  | 24. L1.8.E t42.7.A  | 48. EE0C1.A L1.1.A |
| 9. EE1A1.A L1.9.B   | 25. -               | 49. EE1C5.A L1.5.B |
| 10. EE1A8.A L1.16.B | 26. -               | 50. EE1C4.A L1.4.B |
| 11. EE1A2.A L1.10.B | 27. -               | 51. EE1C6.A L1.6.B |
| 12. EE1A7.A L1.15.B | 28. -               | 52. EE1C3.B L1.3.B |
| 13. EE1A3.A L1.11.B | 29. -               | 53. EE1C7.B L1.7.B |
| 14. EE1A6.A L1.14.B | 30. -               | 54. EE1C2.B L1.2.B |
| 15. EE1A4.A L1.12.B | 31. -               | 55. EE1C8.B L1.8.B |
| 16. EE1A5.A L1.13.B | 32. -               | 56. EE1C1.B L1.1.B |
|                     | 33. L1.16.E t42.8.A |                    |
|                     | 34. L1.15.E t42.8.B |                    |
|                     | 35. L1.14.E t42.6.A |                    |
|                     | 36. L1.13.E t42.6.B |                    |
|                     | 37. L1.4.E t42.3.A  |                    |
|                     | 38. L1.3.E t42.3.B  |                    |
|                     | 39. L1.2.E t42.1.A  |                    |
|                     | 40. L1.1.E t42.1.B  |                    |

## LArFOX\_B Back Panel

1. -	17. -	33. -
2. -	18. -	34. -
3. -	19. -	35. -
4. -	20. -	36. -
5. -	21. -	37. -
6. -	22. -	38. -
7. -	23. -	39. -
8. -	24. -	40. -
9. L2.8.D tsXC16.B	25. C1.1.E tsXC1.C	41. L2.12.D tsXA20.B
10. L2.1.D tsXC9.B	26. C1.8.E tsXC8.C	42. L2.13.D tsXA21.B
11. L2.7.D tsXC15.B	27. C1.2.E tsXC2.C	43. L2.11.D tsXA19.B
12. L2.2.D tsXC10.B	28. C1.7.E tsXC7.C	44. L2.14.D tsXA22.B
13. L2.6.D tsXC14.B	29. C1.3.E tsXC3.C	45. L2.10.D tsXA18.B
14. L2.3.D tsXC11.B	30. C1.6.E tsXC6.C	46. L2.15.D tsXA23.B
15. L2.5.D tsXC13.B	31. C1.4.E tsXC4.C	47. L2.9.D tsXA17.B
16. L2.4.D tsXC12.B	32. C1.5.E tsXC5.C	48. L2.16.D tsXA24.B

**F**

16 x EMEC (C-side)

16 x TileFOX\_E/F

16 x EMEC (A-side)

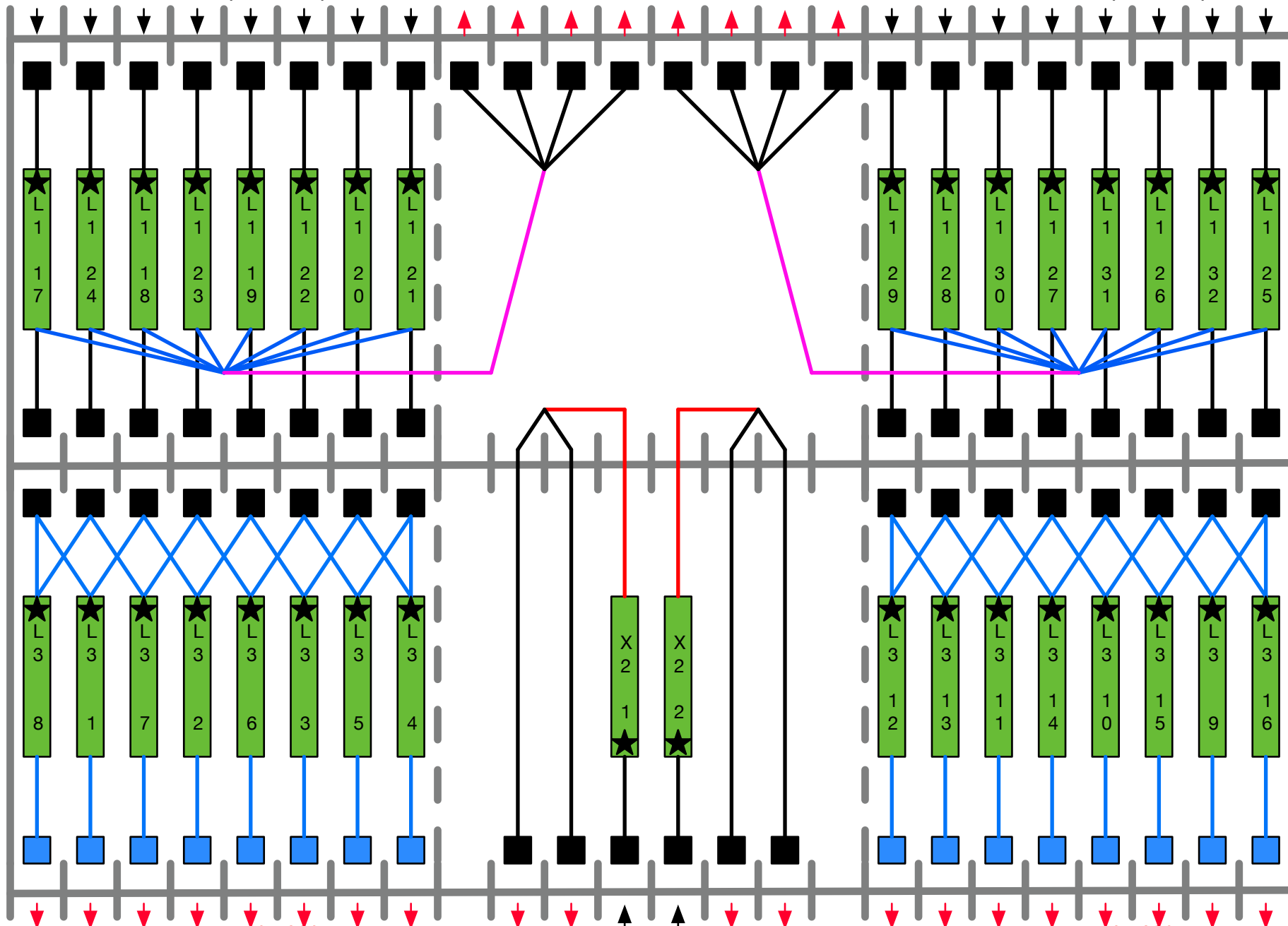
**LArFOX D****Key**

x1

x2

x4

x8

x16

Shuffle  
BoxShort  
SideInput/  
Output**B**

8 x eFEX (A/C)

4 x eFEX (Barrel)

4 x TRES eFEX

4 x eFEX (Barrel)

8 x eFEX (A/C)

# LArFOX\_D

## Outside Box View - Head On

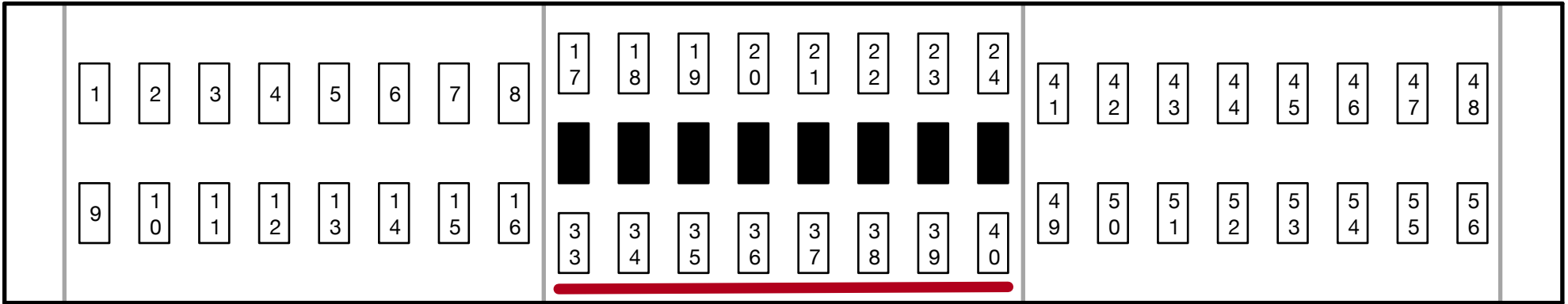

F

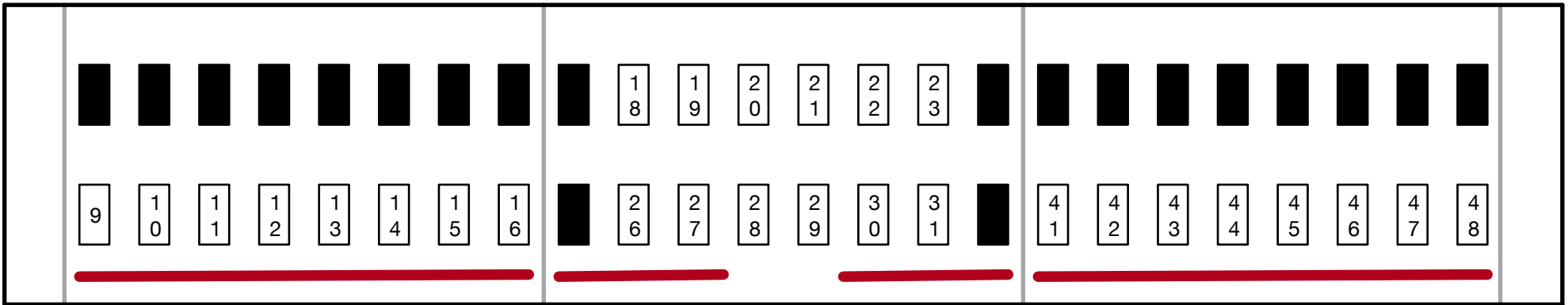

B

## LArFOX D Front Panel

- |                     |                      |                     |
|---------------------|----------------------|---------------------|
| 1. EC0A1.A L1.25.A  | 17. L1.25.E t42.10.B | 41. EC0C5.A L1.21.A |
| 2. EC0A8.A L1.32.A  | 18. L1.26.E t42.10.A | 42. EC0C4.A L1.20.A |
| 3. EC0A2.A L1.26.A  | 19. L1.27.E t42.12.B | 43. EC0C6.A L1.22.A |
| 4. EC0A7.A L1.31.A  | 20. L1.28.E t42.12.A | 44. EC0C3.A L1.19.A |
| 5. EC0A3.A L1.27.A  | 21. L1.21.E t42.13.B | 45. EC0C7.A L1.23.A |
| 6. EC0A6.A L1.30.A  | 22. L1.22.E t42.13.A | 46. EC0C2.A L1.18.A |
| 7. EC0A4.A L1.28.A  | 23. L1.23.E t42.15.B | 47. EC0C8.A L1.24.A |
| 8. EC0A5.A L1.29.A  | 24. L1.24.E t42.15.A | 48. EC0C1.A L1.17.A |
| 9. EC1A1.A L1.25.B  | 25. -                | 49. EC1C5.A L1.21.B |
| 10. EC1A8.A L1.32.B | 26. -                | 50. EC1C4.A L1.20.B |
| 11. EC1A2.A L1.26.B | 27. -                | 51. EC1C6.A L1.22.B |
| 12. EC1A7.A L1.31.B | 28. -                | 52. EC1C3.A L1.19.B |
| 13. EC1A3.A L1.27.B | 29. -                | 53. EC1C7.A L1.23.B |
| 14. EC1A6.A L1.30.B | 30. -                | 54. EC1C2.A L1.18.B |
| 15. EC1A4.A L1.28.B | 31. -                | 55. EC1C8.A L1.24.B |
| 16. EC1A5.A L1.29.B | 32. -                | 56. EC1C1.A L1.17.B |
|                     | 33. L1.32.E t42.16.A |                     |
|                     | 34. L1.31.E t42.16.B |                     |
|                     | 35. L1.30.E t42.14.A |                     |
|                     | 36. L1.29.E t42.14.B |                     |
|                     | 37. L1.20.E t42.11.A |                     |
|                     | 38. L1.19.E t42.11.B |                     |
|                     | 39. L1.18.E t42.9.A  |                     |
|                     | 40. L1.17.E t42.9.B  |                     |

## LArFOX D Back Panel

- |                     |                    |                      |
|---------------------|--------------------|----------------------|
| 1. -                | 17. -              | 33. -                |
| 2. -                | 18. X2.1.E teX1.A  | 34. -                |
| 3. -                | 19. X2.1.F teX2.A  | 35. -                |
| 4. -                | 20. t48.1.B X2.1.B | 36. -                |
| 5. -                | 21. t48.2.B X2.2.B | 37. -                |
| 6. -                | 22. X2.2.E teX5.A  | 38. -                |
| 7. -                | 23. X2.2.F teX6.A  | 39. -                |
| 8. -                | 24. -              | 40. -                |
| 9. L3.8.D tsXC16.A  | 25. -              | 41. L3.12.D tsXA20.A |
| 10. L3.1.D tsXC9.A  | 26. X2.1.G teX3.A  | 42. L3.13.D tsXA21.A |
| 11. L3.7.D tsXC15.A | 27. X2.1.H teX4.A  | 43. L3.11.D tsXA19.A |
| 12. L3.2.D tsXC10.A | 28. t48.7.B X2.1.C | 44. L3.14.D tsXA22.A |
| 13. L3.6.D tsXC14.A | 29. t48.8.B X2.2.C | 45. L3.10.D tsXA18.A |
| 14. L3.3.D tsXC11.A | 30. X2.2.G teX7.A  | 46. L3.15.D tsXA23.A |
| 15. L3.5.D tsXC13.A | 31. X2.2.H teX8.A  | 47. L3.9.D tsXA17.A  |
| 16. L3.4.D tsXC12.A | 32. -              | 48. L3.16.D tsXA24.A |

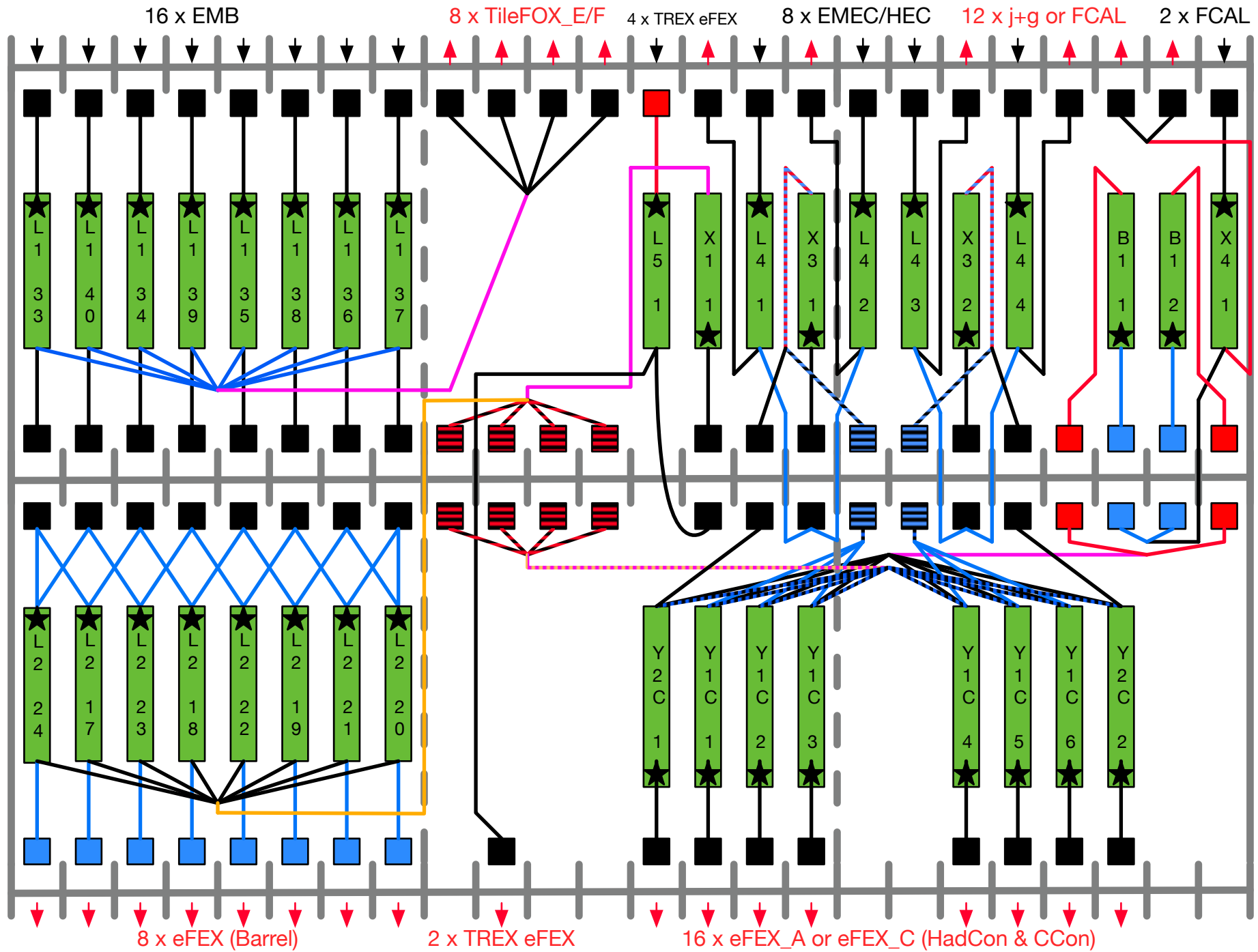

**F****B**

LArFOX\_C

Outside Box View - Head On

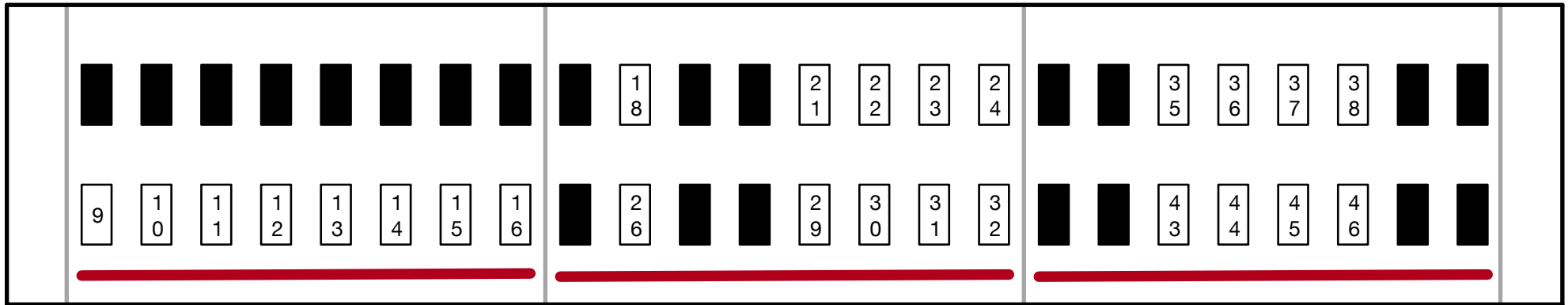
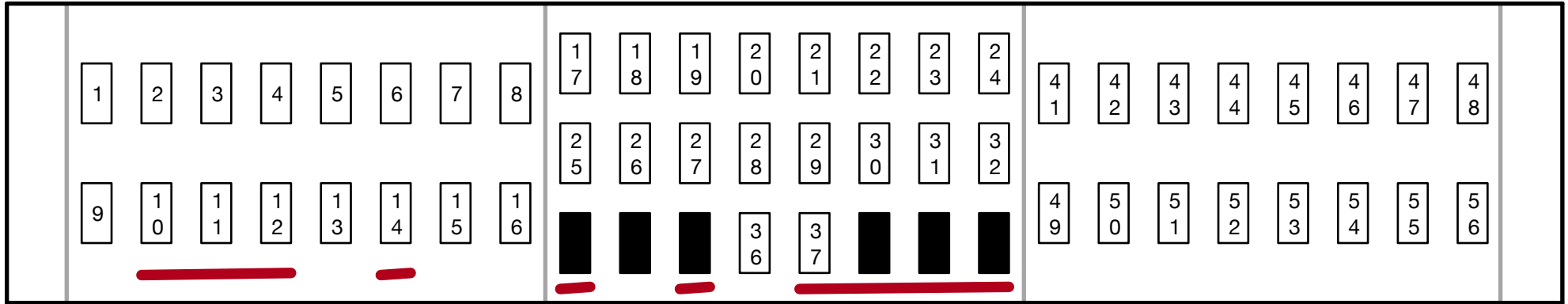

## LArFOX C Front Panel

- |                    |                      |                     |
|--------------------|----------------------|---------------------|
| 1. FL1C.A X4.1.A   | 17. L4.2.E t48.4.A   | 41. EB0C5.A L1.37.A |
| 2. X4.1.F t24.3.A  | 18. EHC1.A L4.1.A    | 42. EB0C4.A L1.36.A |
| 3. X4.1.H t12.1.A  | 19. L4.1.E t48.3.A   | 43. EB0C6.A L1.38.A |
| 4. L4.4.E t48.6.A  | 20. TEC1.A L5.1.A    | 44. EB0C3.A L1.35.A |
| 5. EHC7.A L4.4.A   | 21. L1.36.E t42.19.A | 45. EB0C7.A L1.39.A |
| 6. L4.3.E t48.5.A  | 22. L1.35.E t42.19.B | 46. EB0C2.A L1.34.A |
| 7. EHC5.A L4.3.A   | 23. L1.34.E t42.17.A | 47. EB0C8.A L1.40.A |
| 8. EHC3.A L4.2.A   | 24. L1.33.E t42.17.B | 48. EB0C1.A L1.33.A |
| 9. FL2C.A X4.1.B   | 25. L4.2.F t24.2.A   | 49. EB1C5.A L1.37.B |
| 10. X4.1.G t24.6.A | 26. EHC2.A L4.1.B    | 50. EB1C4.A L1.36.B |
| 11. X4.1.I t12.2.A | 27. L4.1.F t24.1.A   | 51. EB1C6.A L1.38.B |
| 12. L4.4.F t24.5.A | 28. TEC2.A L5.1.B    | 52. EB1C3.A L1.35.B |
| 13. EHC8.A L4.4.B  | 29. L1.37.E t42.21.B | 53. EB1C7.A L1.39.B |
| 14. L4.3.F t24.4.A | 30. L1.38.E t42.21.A | 54. EB1C2.A L1.34.B |
| 15. EHC6.A L4.3.B  | 31. L1.39.E t42.23.B | 55. EB1C8.A L1.40.B |
| 16. EHC4.A L4.2.B  | 32. L1.40.E t42.23.A | 56. EB1C1.A L1.33.B |
|                    | 33. -                |                     |
|                    | 34. -                |                     |
|                    | 35. -                |                     |
|                    | 36. TEC3.A L5.1.C    |                     |
|                    | 37. TEC4.A L5.1.D    |                     |
|                    | 38. -                |                     |
|                    | 39. -                |                     |
|                    | 40. -                |                     |

## LArFOX C Back Panel

- |                     |                      |                      |
|---------------------|----------------------|----------------------|
| 1. -                | 17. -                | 33. -                |
| 2. -                | 18. L5.1.F t48.1.A   | 34. -                |
| 3. -                | 19. -                | 35. Y1C.4.G tsXC13.C |
| 4. -                | 20. -                | 36. Y1C.5.G tsXC14.C |
| 5. -                | 21. Y2C.1.H tsXC16.C | 37. Y1C.6.G tsXC15.C |
| 6. -                | 22. Y1C.1.G tsXC9.C  | 38. Y2C.2.H tsXC12.C |
| 7. -                | 23. Y1C.2.G tsXC10.C | 39. -                |
| 8. -                | 24. Y1C.3.G tsXC11.C | 40. -                |
| 9. L2.24.D tsXC8.A  | 25. -                | 41. -                |
| 10. L2.17.D tsXC1.A | 26. L5.1.H t48.2.A   | 42. -                |
| 11. L2.23.D tsXC7.A | 27. -                | 43. Y1C.4.H teX13.A  |
| 12. L2.18.D tsXC2.A | 28. -                | 44. Y1C.5.H teX14.A  |
| 13. L2.22.D tsXC6.A | 29. Y2C.1.I teX16.A  | 45. Y1C.6.H teX15.A  |
| 14. L2.19.D tsXC3.A | 30. Y1C.1.H teX9.A   | 46. Y2C.2.I teX12.A  |
| 15. L2.21.D tsXC5.A | 31. Y1C.2.H teX10.A  | 47. -                |
| 16. L2.20.D tsXC4.A | 32. Y1C.3.H teX11.A  | 48. -                |

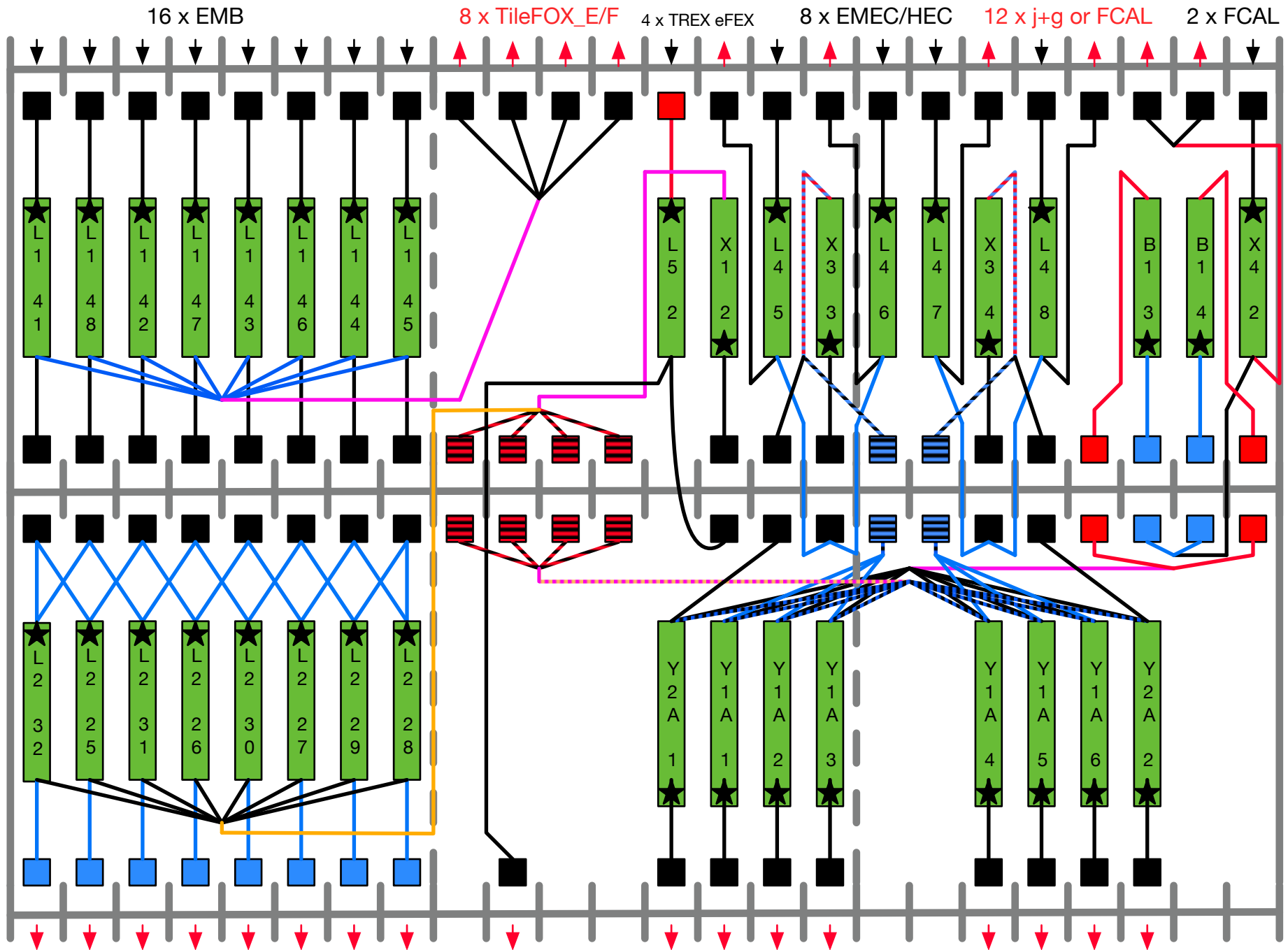
**F****B**

8 x eFEX (Barrel)

2 x TREX eFEX

16 x eFEX\_A or eFEX\_C (HadCon &amp; CCon)

LArFOX\_A

Outside Box View - Head On

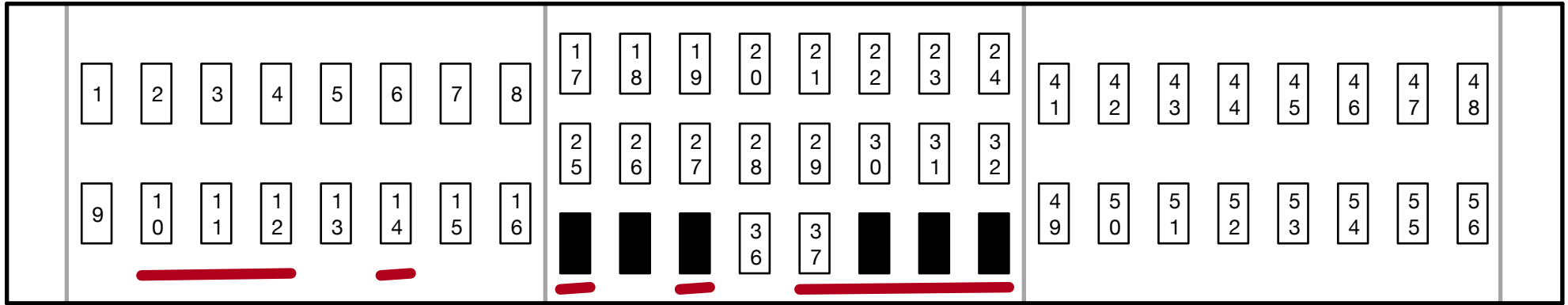

F

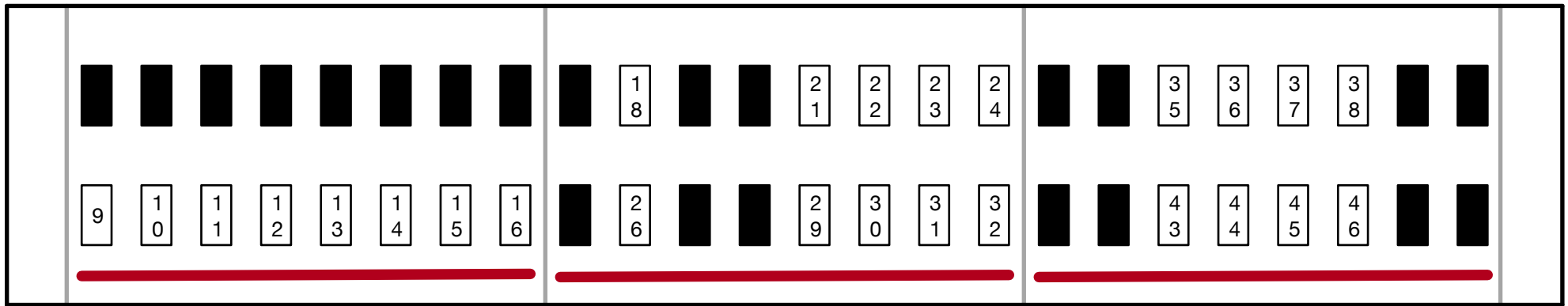

B

## LArFOX A Front Panel

- |                     |                      |                     |
|---------------------|----------------------|---------------------|
| 1. FL1A.A X4.2.A    | 17. L4.6.E t48.10.A  | 41. EB0A5.A L1.45.A |
| 2. X4.2.F t24.9.A   | 18. EHA1.A L4.5.A    | 42. EB0A4.A L1.44.A |
| 3. X4.2.H t12.3.A   | 19. L4.5.E t48.9.A   | 43. EB0A6.A L1.46.A |
| 4. L4.8.E t48.12.A  | 20. TEA1.A L5.2.A    | 44. EB0A3.A L1.43.A |
| 5. EHA7.A L4.8.A    | 21. L1.44.E t42.20.A | 45. EB0A7.A L1.47.A |
| 6. L4.7.E t48.11.A  | 22. L1.43.E t42.20.B | 46. EB0A2.A L1.42.A |
| 7. EHA5.A L4.7.A    | 23. L1.42.E t42.18.A | 47. EB0A8.A L1.48.A |
| 8. EHA3.A L4.6.A    | 24. L1.41.E t42.18.B | 48. EB0A1.A L1.41.A |
| 9. FL2A.A X4.2.B    | 25. L4.6.F t24.8.A   | 49. EB1A5.A L1.45.B |
| 10. X4.2.G t24.12.A | 26. EHA2.A L4.5.B    | 50. EB1A4.A L1.44.B |
| 11. X4.2.I t12.4.A  | 27. L4.5.F t24.7.A   | 51. EB1A6.A L1.46.B |
| 12. L4.8.F t24.11.A | 28. TEA2.A L5.2.B    | 52. EB1A3.A L1.43.B |
| 13. EHA8.A L4.8.B   | 29. L1.45.E t42.22.B | 53. EB1A7.A L1.47.B |
| 14. L4.7.F t24.10.A | 30. L1.46.E t42.22.A | 54. EB1A2.A L1.42.B |
| 15. EHA6.A L4.7.B   | 31. L1.47.E t42.24.B | 55. EB1A8.A L1.48.B |
| 16. EHA4.A L4.6.B   | 32. L1.48.E t42.24.A | 56. EB1A1.A L1.41.B |
|                     | 33. -                |                     |
|                     | 34. -                |                     |
|                     | 35. -                |                     |
|                     | 36. TEA3.A L5.2.C    |                     |
|                     | 37. TEA4.A L5.2.D    |                     |
|                     | 38. -                |                     |
|                     | 39. -                |                     |
|                     | 40. -                |                     |

## LArFOX A Back Panel

- |                     |                      |                      |
|---------------------|----------------------|----------------------|
| 1. -                | 17. -                | 33. -                |
| 2. -                | 18. L5.2.F t48.7.A   | 34. -                |
| 3. -                | 19. -                | 35. Y1A.4.G tsXA21.C |
| 4. -                | 20. -                | 36. Y1A.5.G tsXA22.C |
| 5. -                | 21. Y2A.1.H tsXA24.C | 37. Y1A.6.G tsXA23.C |
| 6. -                | 22. Y1A.1.G tsXA17.C | 38. Y2A.2.H tsXA20.C |
| 7. -                | 23. Y1A.2.G tsXA18.C | 39. -                |
| 8. -                | 24. Y1A.3.G tsXA19.C | 40. -                |
| 9. L2.32.D tsXC8.B  | 25. -                | 41. -                |
| 10. L2.25.D tsXC1.B | 26. L5.2.H t48.8.A   | 42. -                |
| 11. L2.31.D tsXC7.B | 27. -                | 43. Y1A.4.H teX21.A  |
| 12. L2.26.D tsXC2.B | 28. -                | 44. Y1A.5.H teX22.A  |
| 13. L2.30.D tsXC6.B | 29. Y2A.1.I teX24.A  | 45. Y1A.6.H teX23.A  |
| 14. L2.27.D tsXC3.B | 30. Y1A.1.H teX17.A  | 46. Y2A.2.I teX20.A  |
| 15. L2.29.D tsXC5.B | 31. Y1A.2.H teX18.A  | 47. -                |
| 16. L2.28.D tsXC4.B | 32. Y1A.3.H teX19.A  | 48. -                |

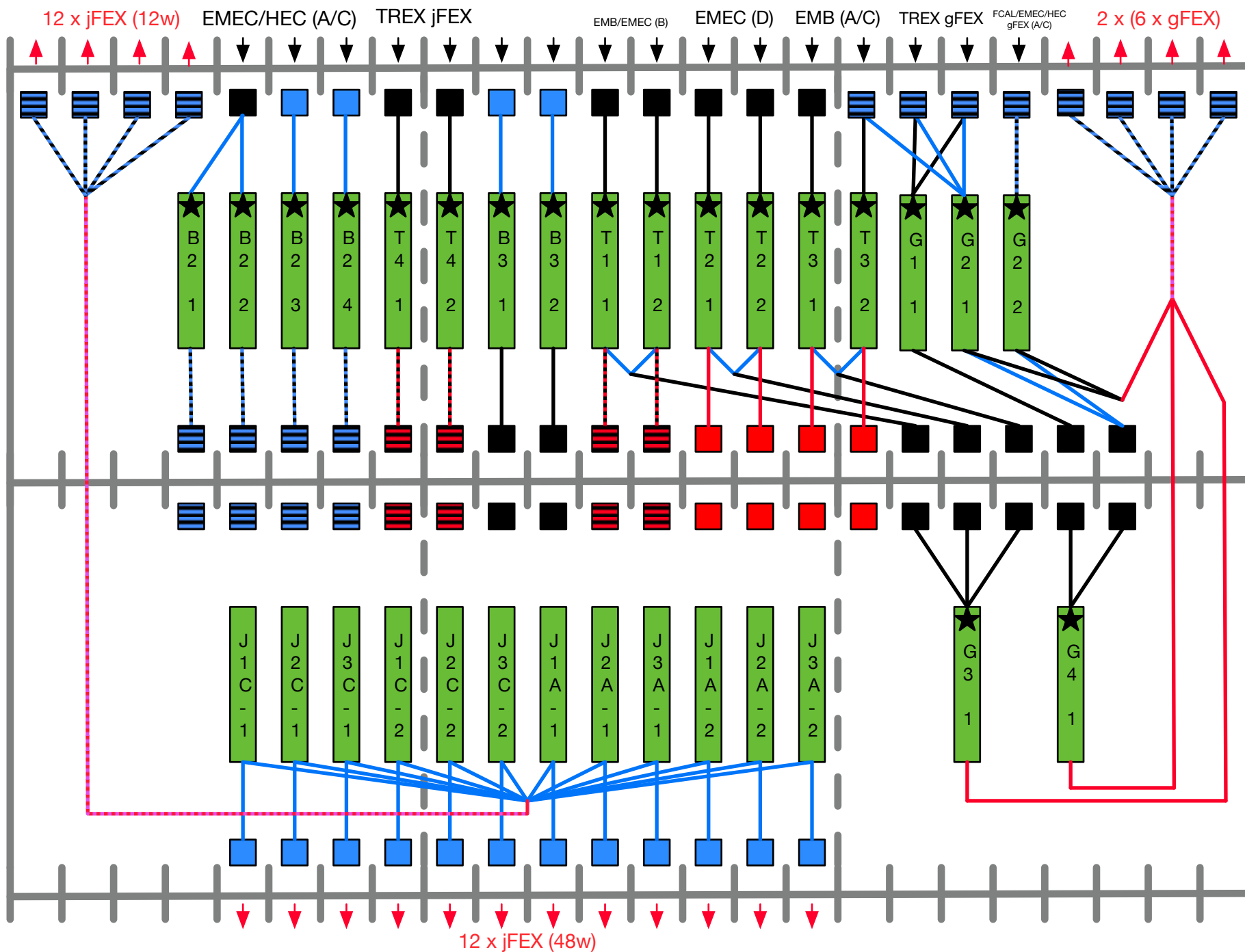

**F****B****TileFOX E****Key**

- x1
- x2
- x4
- x8
- x16
- Shuffle Box
- Short Side
- Input/Output

# TileFOX E

## Outside Box View - Head On

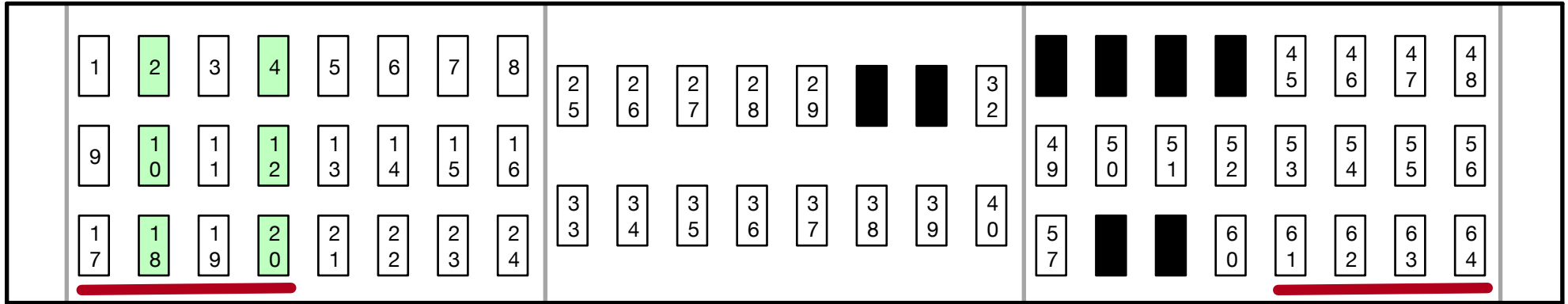

F

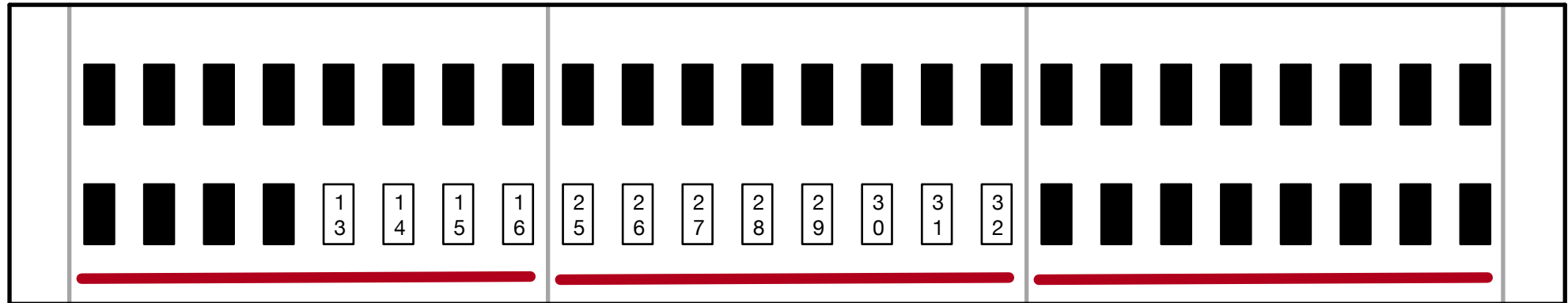

B

## TileFOX E Front Panel

- |                     |                     |                     |
|---------------------|---------------------|---------------------|
| 1. G3.1.G tgX.1.B   | 25. t42.17.C T3.1.A | 41. -               |
| 2. G3.1.H [SpaC1]   | 26. t42.11.C T2.2.A | 42. -               |
| 3. G3.1.J tgX.3.B   | 27. t42.9.C T2.1.A  | 43. -               |
| 4. G3.1.K [SpaC2]   | 28. t42.3.C T1.2.A  | 44. -               |
| 5. t12.3.B G2.2.A   | 29. t42.1.C T1.1.A  | 45. J1A.2.G tjX26.C |
| 6. t24.2.B G2.1.C   | 30. -               | 46. J1A.1.G tjX26.D |
| 7. t24.1.B G2.1.B   | 31. -               | 47. J1C.2.G tjX25.C |
| 8. t12.1.B G2.1.A   | 32. TJC2.A T4.2.A   | 48. J1C.1.G tjX25.D |
| 9. G4.1.E tgX.5.B   | 33. t42.18.C T3.1.B | 49. TJC1.A T4.1.A   |
| 10. G4.1.F [SpaC3]  | 34. t42.12.C T2.2.B | 50. t48.10.B B2.4.A |
| 11. G4.1.G tgX.7.B  | 35. t42.10.C T2.1.B | 51. t48.9.B B2.3.A  |
| 12. G4.1.H [SpaC4]  | 36. t42.4.C T1.2.B  | 52. t48.3.B B2.1.A  |
| 13. t24.7.B G2.2.B  | 37. t42.2.C T1.1.B  | 53. J2A.2.G tjX28.C |
| 14. TGC1.A G1.1.A   | 38. t24.9.B B3.2.A  | 54. J2A.1.G tjX28.D |
| 15. TGC2.A G1.1.B   | 39. t24.3.B B3.1.A  | 55. J2C.2.G tjX27.C |
| 16. t42.19.C T3.2.A | 40. TJA2.A T4.2.B   | 56. J2C.1.G tjX27.D |
| 17. G2.1.F tgX.9.B  |                     | 57. TJA1.A T4.1.B   |
| 18. G2.1.G [SpaC5]  |                     | 58. -               |
| 19. G2.2.F tgX.11.B |                     | 59. -               |
| 20. G2.2.G [SpaC6]  |                     | 60. t48.4.B B2.2.A  |
| 21. t24.8.B G2.2.C  |                     | 61. J3A.2.F tjX30.C |
| 22. TGA1.A G1.1.C   |                     | 62. J3A.1.F tjX30.D |
| 23. TGA2.A G1.1.D   |                     | 63. J3C.2.F tjX29.C |
| 24. t42.20.C T3.2.B |                     | 64. J3C.1.F tjX29.D |

## TileFOX E Back Panel

1. -	17. -	33. -
2. -	18. -	34. -
3. -	19. -	35. -
4. -	20. -	36. -
5. -	21. -	37. -
6. -	22. -	38. -
7. -	23. -	39. -
8. -	24. -	40. -
9. -	25. J2C.2.F tjX10.A	41. -
10. -	26. J3C.2.E tjX18.A	42. -
11. -	27. J1A.1.F tjX5.A	43. -
12. -	28. J2A.1.F tjX13.A	44. -
13. J1C.1.F tjX1.A	29. J3A.1.E tjX21.A	45. -
14. J2C.1.F tjX9.A	30. J1A.2.F tjX6.A	46. -
15. J3C.1.E tjX17.A	31. J2A.2.F tjX14.A	47. -
16. J1C.2.F tjX2.A	32. J3A.2.E tjX22.A	48. -

**F**

12 x jFEX (12w)    EMEC/HEC (A/C)    TREX jFEX    EMB/EMEC (B)    EMEC (D)    EMB (A/C)    TREX gFEX    FCAL/EMEC/HEC gFEX (A/C)    2 x (6 x gFEX)

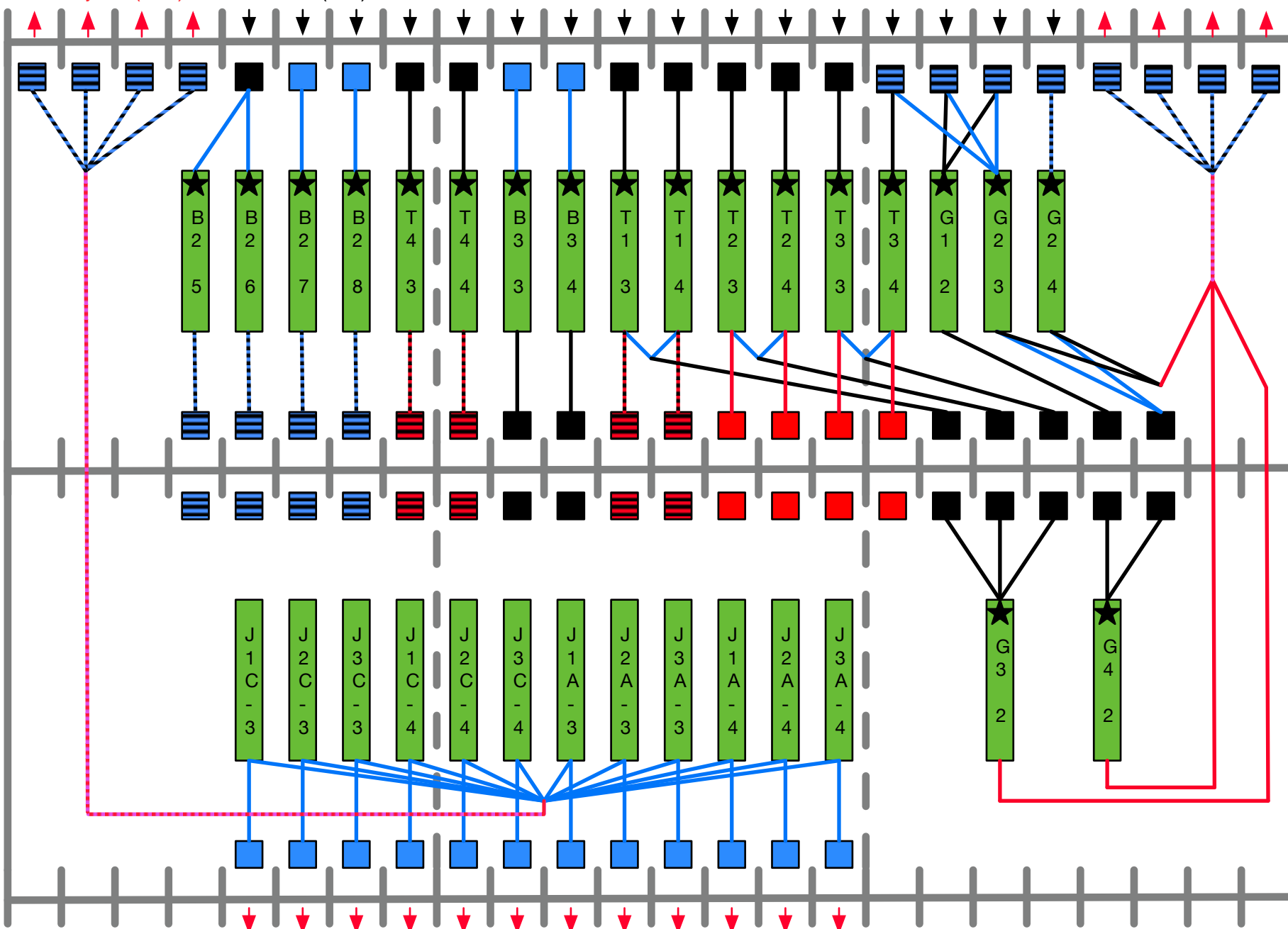
**TileFOX F****Key**

x1

x2

x4

x8

x16

Shuffle Box

Short Side

Input/Output

**B**

12 x jFEX (48w)

# TileFOX F

## Outside Box View - Head On

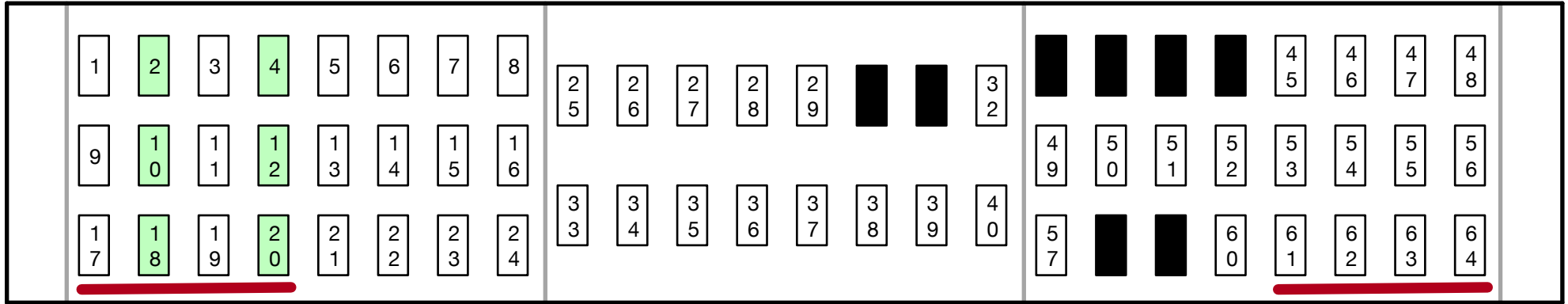

F

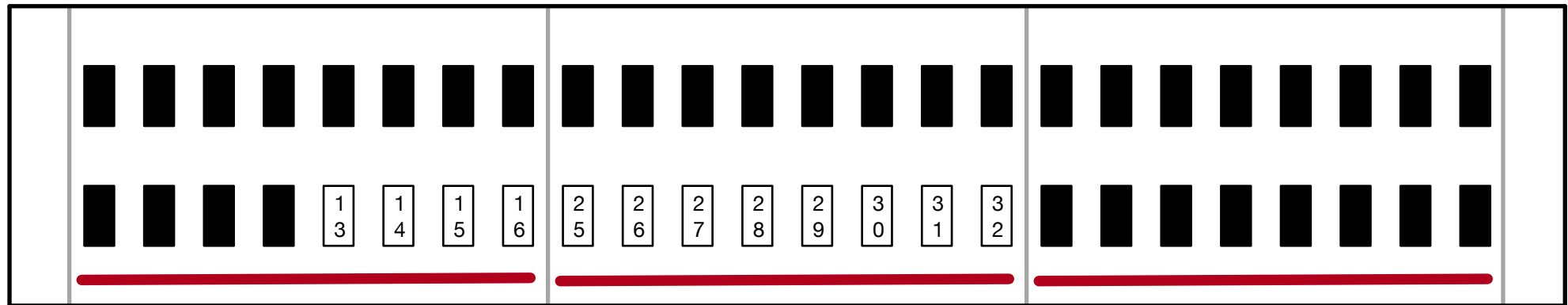

B

## TileFOX F Front Panel

- |                     |                     |                     |
|---------------------|---------------------|---------------------|
| 1. G3.2.G tgX.1.A   | 25. t42.21.C T3.3.A | 41. -               |
| 2. G3.2.H [SpaC1]   | 26. t42.15.C T2.4.A | 42. -               |
| 3. G3.2.J tgX.3.A   | 27. t42.13.C T2.3.A | 43. -               |
| 4. G3.2.K [SpaC2]   | 28. t42.7.C T1.4.A  | 44. -               |
| 5. t12.4.B G2.4.A   | 29. t42.5.C T1.3.A  | 45. J1A.4.G tjX26.A |
| 6. t24.5.B G2.3.C   | 30. -               | 46. J1A.3.G tjX26.B |
| 7. t24.4.B G2.3.B   | 31. -               | 47. J1C.4.G tjX25.A |
| 8. t12.2.B G2.3.A   | 32. TJC4.A T4.4.A   | 48. J1C.3.G tjX25.B |
| 9. G4.2.E tgX.5.A   | 33. t42.22.C T3.3.B | 49. TJC3.A T4.3.A   |
| 10. G4.2.F [SpaC3]  | 34. t42.16.C T2.4.B | 50. t48.12.B B2.8.A |
| 11. G4.2.G tgX.7.A  | 35. t42.14.C T2.3.B | 51. t48.11.B B2.7.A |
| 12. G4.2.H [SpaC4]  | 36. t42.8.C T1.4.B  | 52. t48.5.B B2.5.A  |
| 13. t24.10.B G2.4.B | 37. t42.6.C T1.3.B  | 53. J2A.4.G tjX28.A |
| 14. TGC3.A G1.2.A   | 38. t24.12.B B3.4.A | 54. J2A.3.G tjX28.B |
| 15. TGC4.A G1.2.B   | 39. t24.6.B B3.3.A  | 55. J2C.4.G tjX27.A |
| 16. t42.23.C T3.4.A | 40. TJA4.A T4.4.B   | 56. J2C.3.G tjX27.B |
| 17. G2.3.F tgX.9.A  |                     | 57. TJA3.A T4.3.B   |
| 18. G2.3.G [SpaC5]  |                     | 58. -               |
| 19. G2.4.F tgX.11.A |                     | 59. -               |
| 20. G2.4.G [SpaC6]  |                     | 60. t48.6.B B2.6.A  |
| 21. t24.11.B G2.4.C |                     | 61. J3A.4.F tjX30.A |
| 22. TGA3.A G1.2.C   |                     | 62. J3A.3.F tjX30.B |
| 23. TGA4.A G1.2.D   |                     | 63. J3C.4.F tjX29.A |
| 24. t42.24.C T3.4.B |                     | 64. J3C.3.F tjX29.B |

## TileFOX F Back Panel

1. -	17. -	33. -
2. -	18. -	34. -
3. -	19. -	35. -
4. -	20. -	36. -
5. -	21. -	37. -
6. -	22. -	38. -
7. -	23. -	39. -
8. -	24. -	40. -
9. -	25. J2C.4.F tjX12.A	41. -
10. -	26. J3C.4.E tjX20.A	42. -
11. -	27. J1A.3.F tjX7.A	43. -
12. -	28. J2A.3.F tjX15.A	44. -
13. J1C.3.F tjX3.A	29. J3A.3.E tjX23.A	45. -
14. J2C.3.F tjX11.A	30. J1A.4.F tjX8.A	46. -
15. J3C.3.E tjX19.A	31. J2A.4.F tjX16.A	47. -
16. J1C.4.F tjX4.A	32. J3A.4.E tjX24.A	48. -