

**Note:** which subset of input and output channels are instrumented and which channels receive the passive splitters can be determined at a later date

# LArDPS to eFEX Test – direct path

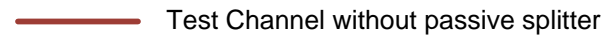
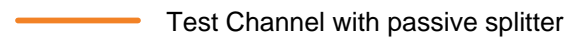
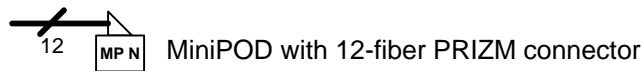
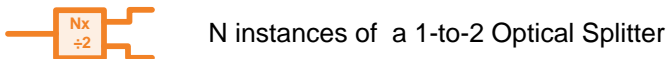
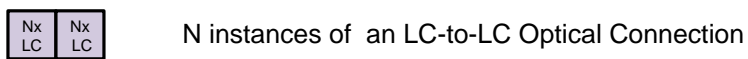
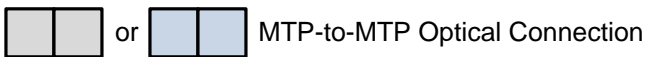
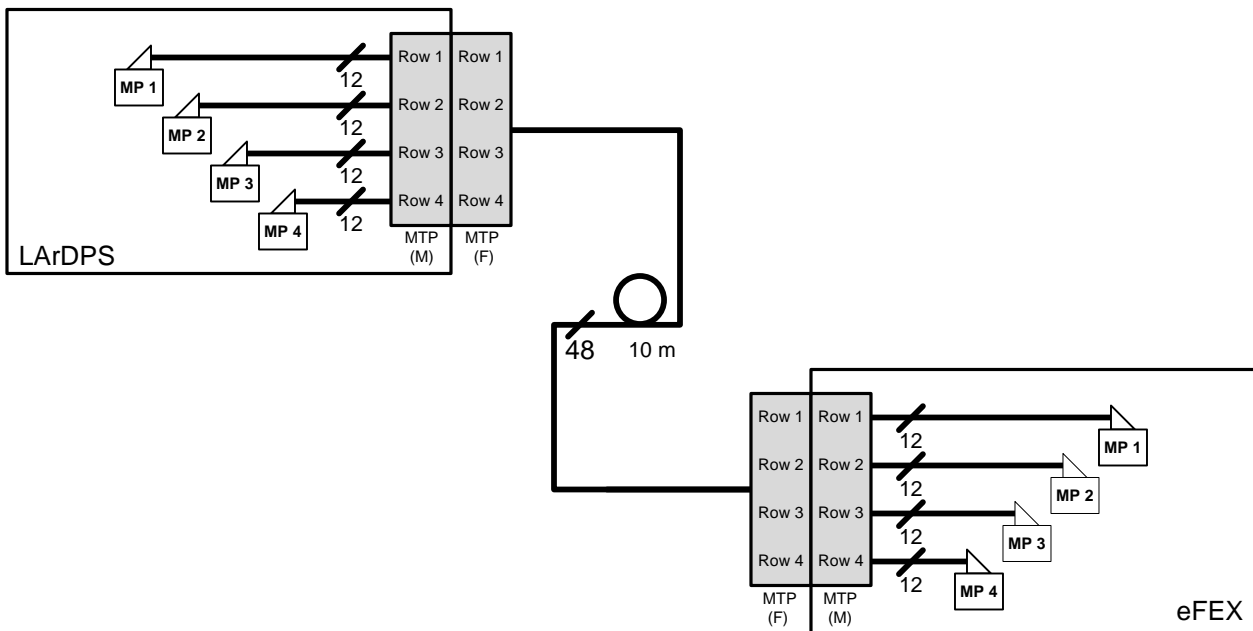

**Note:**

All 48 channels of the LArDPS test module outputs are instrumented.  
 All 48 channels of the eFEX test module inputs are instrumented.  
 The default channel mapping is one-to-one.  
 Additional test configurations with any arbitrary mapping may be specified and will be available as needed.

# LArDPS to eFEX Test -- without splitters

07-Jan-2016

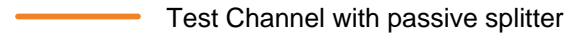
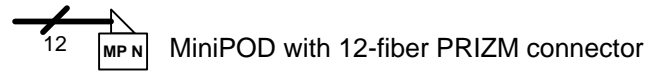
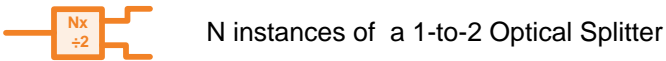
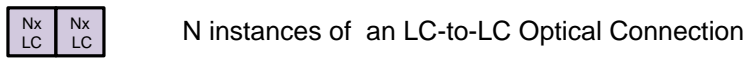
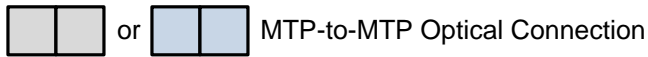
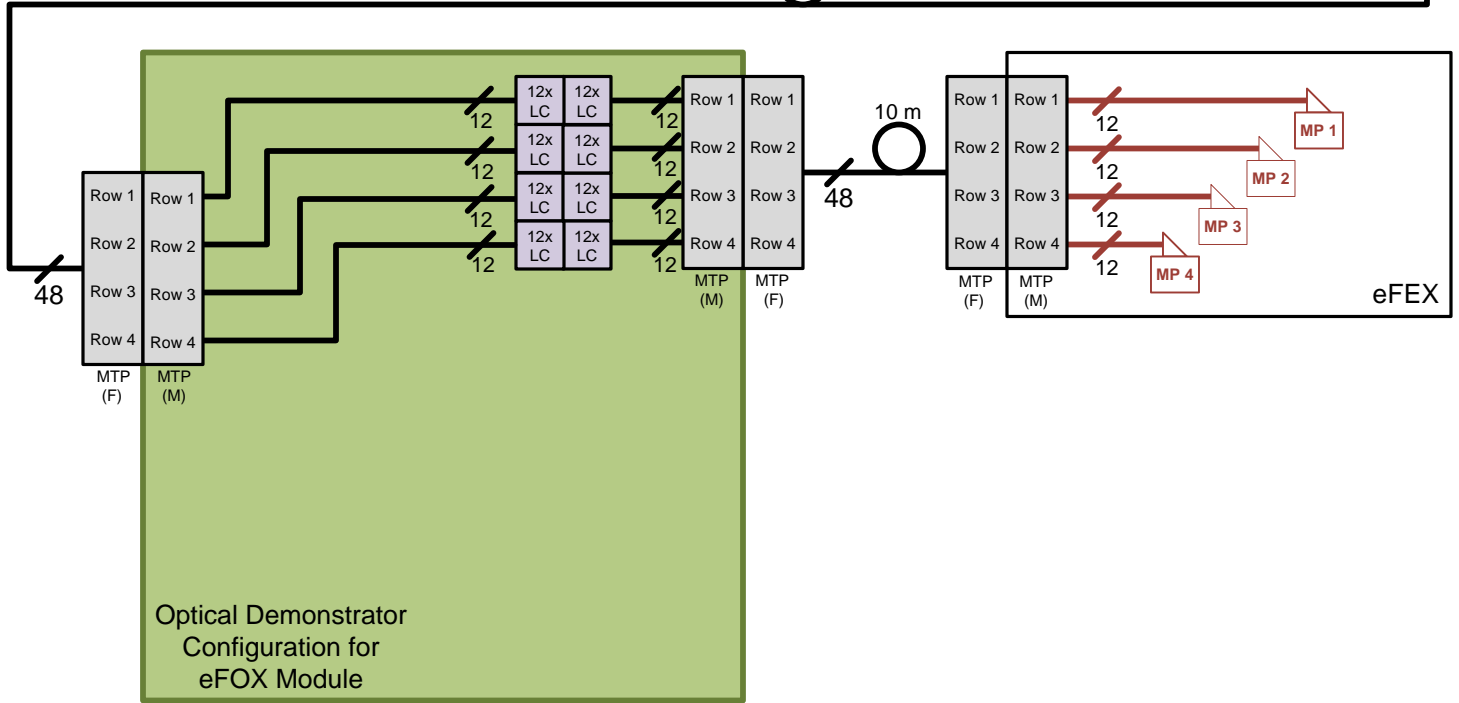
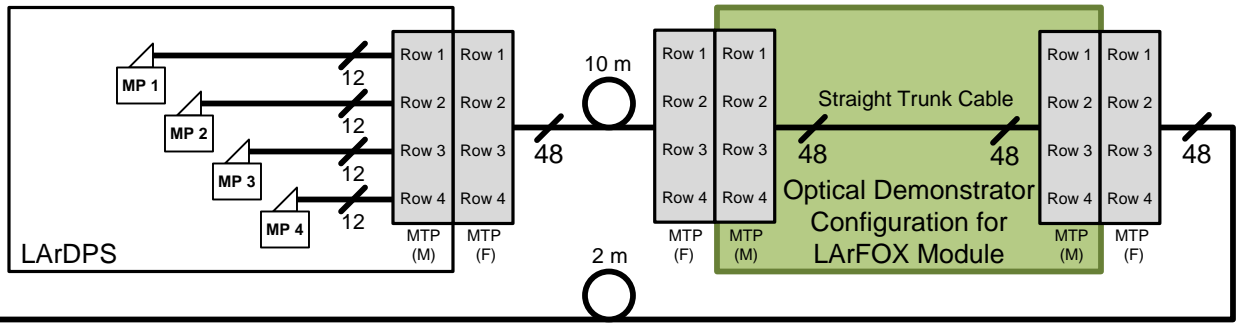

**Note:**

All 48 channels of the LArDPS test module outputs are instrumented. All 48 channels of the eFEX test module inputs are instrumented. The default channel mapping is one-to-one. Additional test configurations with any arbitrary mapping may be specified and will be available as needed.

# LArDPS to eFEX Test -- with splitters

07-Jan-2016

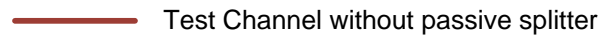
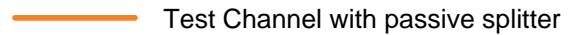
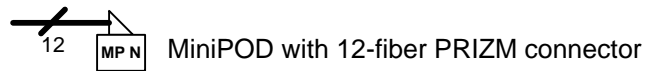
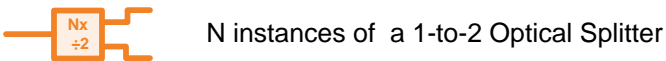
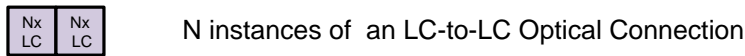
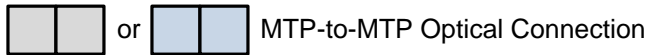
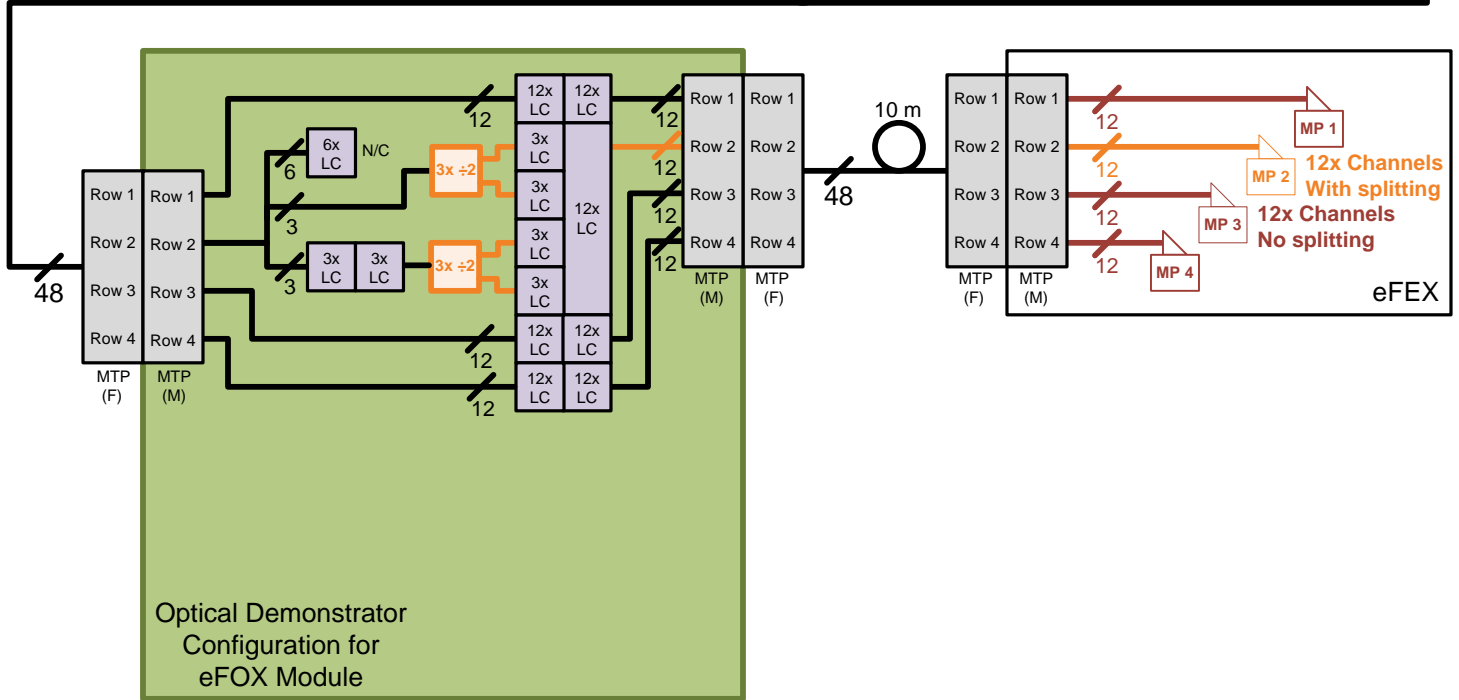
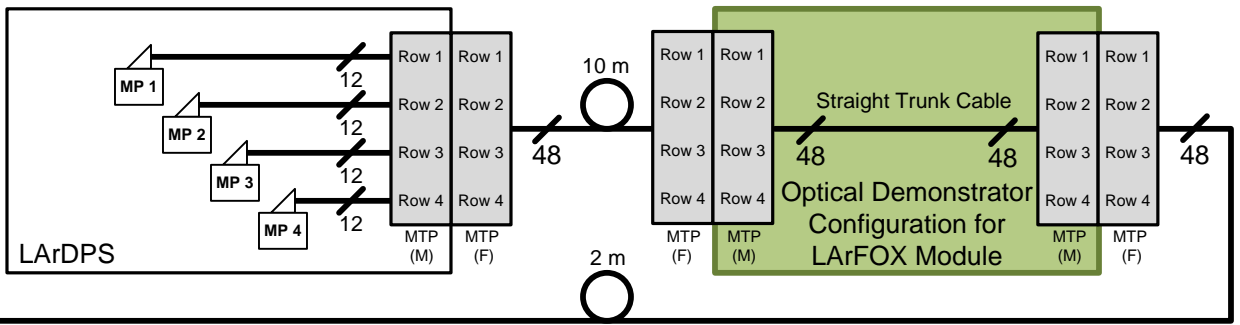

## Note:

42 of 48 channels of the LArDPS test module outputs are instrumented. All 48 channels of the eFEX test module inputs are instrumented. A default channel mapping is suggested in the drawing, see appendix. Additional test configurations with any arbitrary mapping may be specified and will be available as needed.

# LArDPS to gFEX Test -- without splitters

07-Jan-2016

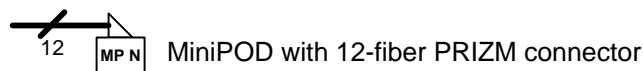
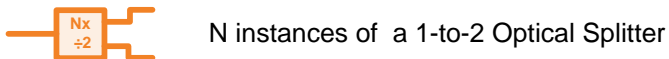
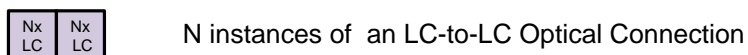
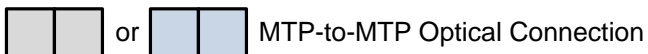
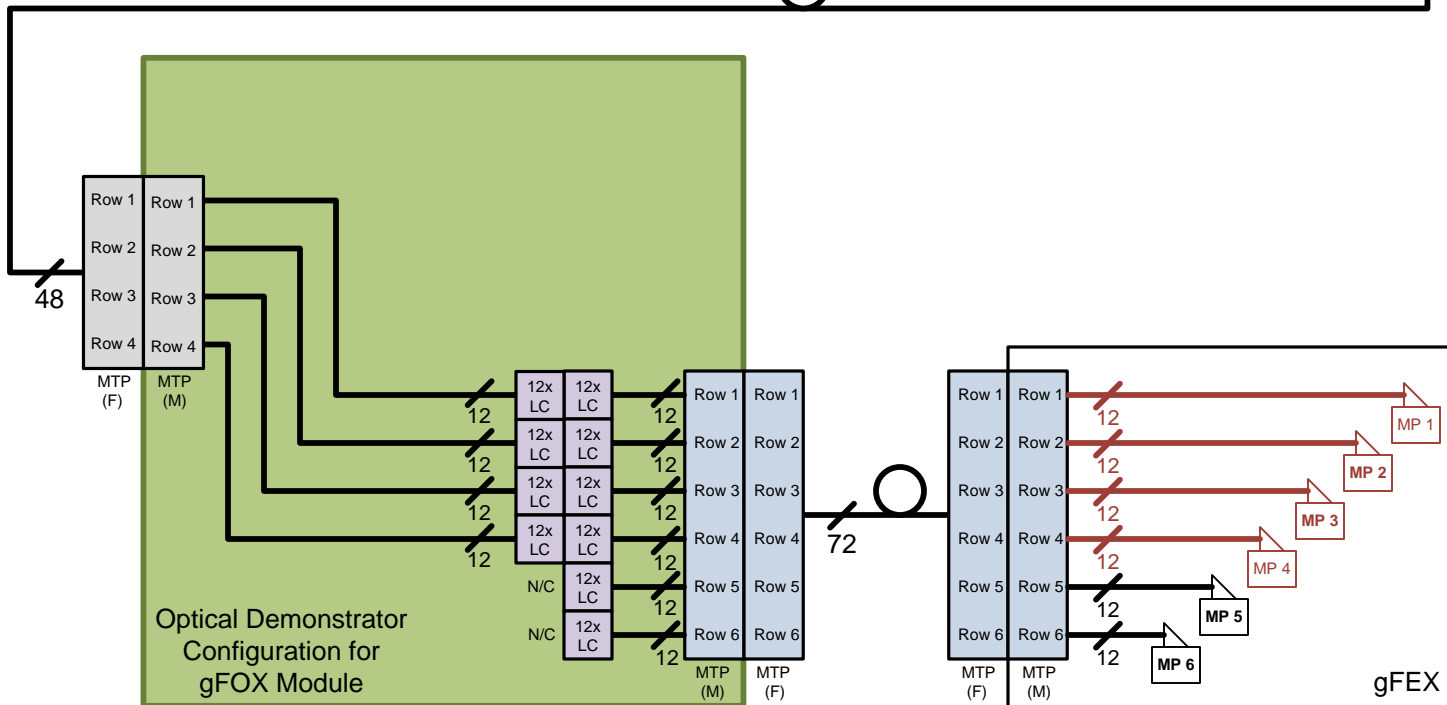
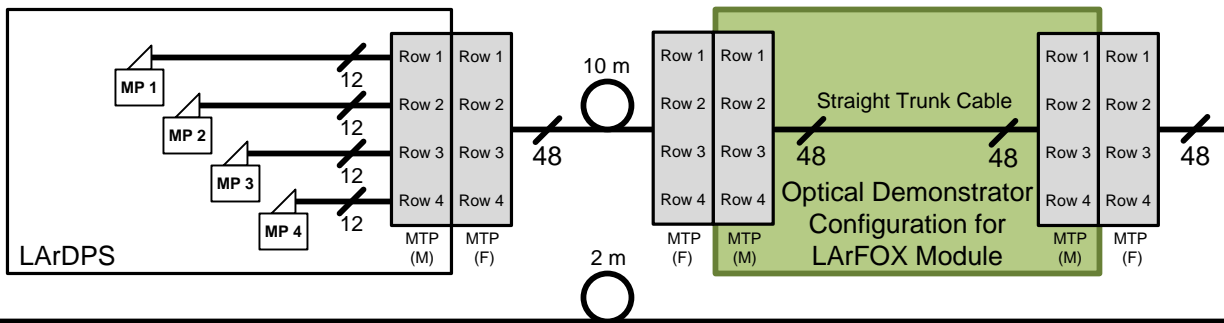

## Note:

All 48 channels of the LArDPS test module outputs are instrumented. 48 of the 72 channels of the gFEX test module inputs are instrumented. The default channel mapping suggested in the drawing is one-to-one for the lower 48 channels with the upper 24 channels remaining dark. Additional test configurations with any arbitrary mapping may be specified and will be available as needed, e.g. instrumenting 8 channels from all 6 of the gFEX miniPODs.

# LArDPS to gFEX Test – with splitters

07-Jan-2016

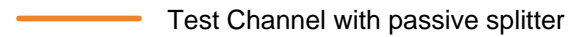
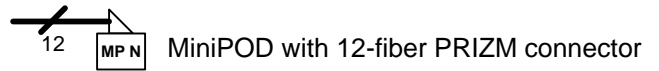
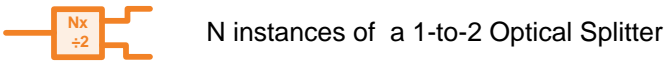
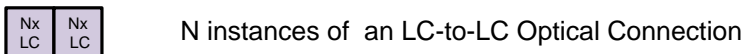
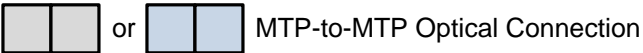
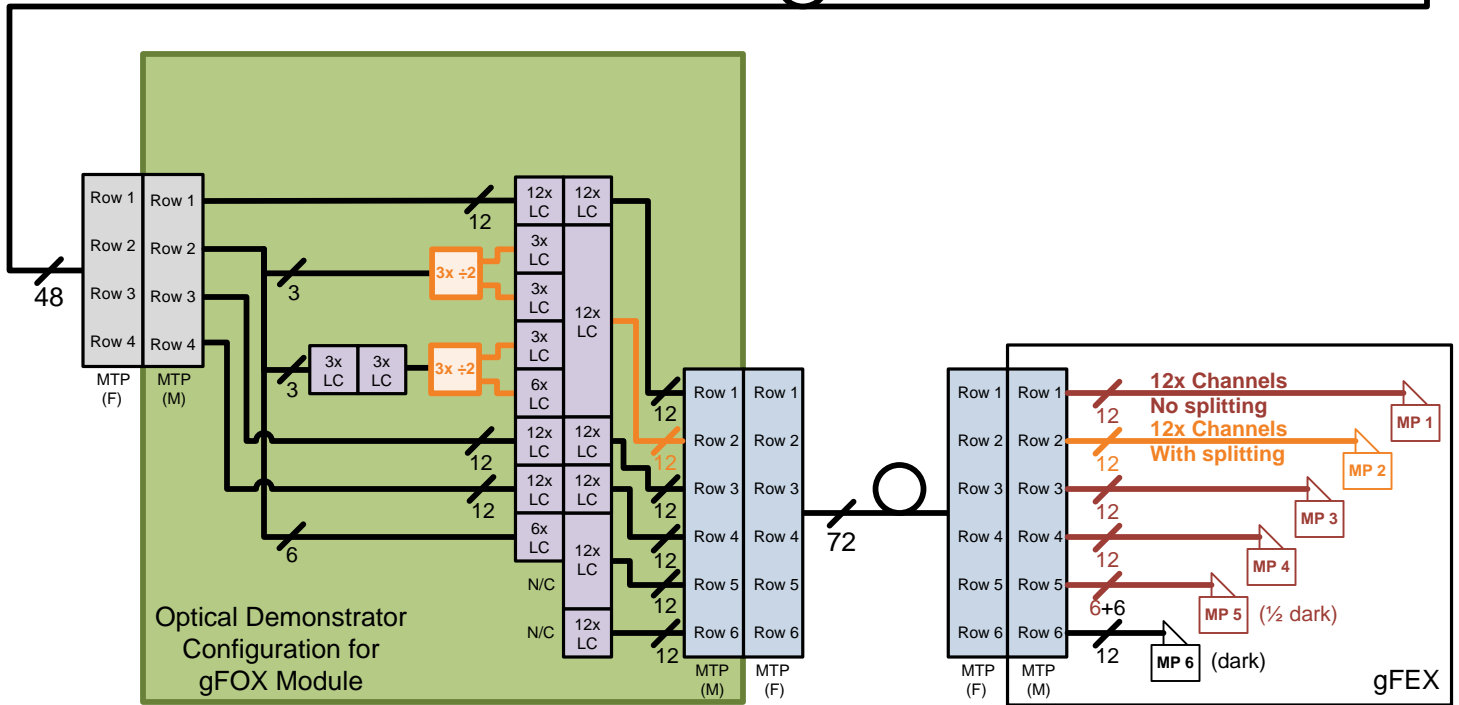
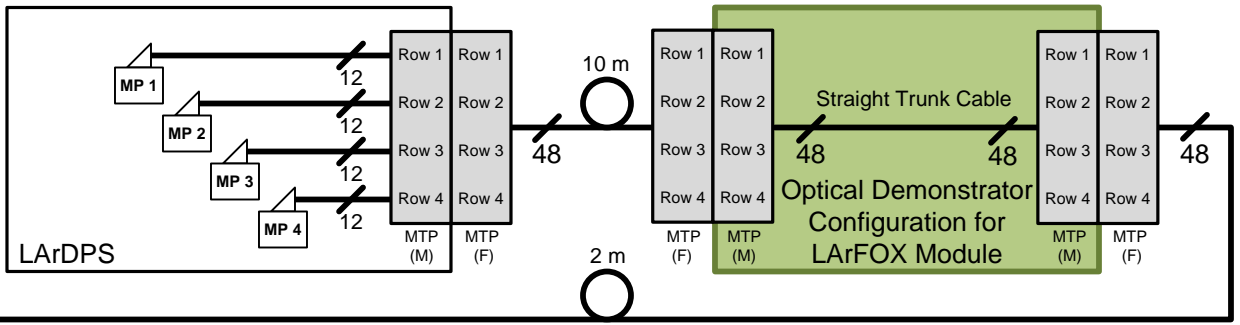

**Note:**

All 48 channels of the LArDPS test module outputs are instrumented. 54 of the 72 channels of the gFEX test module inputs are instrumented. A default channel mapping is suggested in the drawing, see appendix. Additional test configurations with any arbitrary mapping may be specified and will be available as needed.