	TYPE	APPLICATION SPECIFICATION		NUMBER	GS-20-033		
	TITLE	MEG-Array® High Speed Mezzanine Connectors			PAGE	1 of 21	REVISION
				AUTHORIZED BY	D. Horchler		11 Sept 13
				CLASSIFICATION	UNRESTRICTED		

1.0 OBJECTIVE

The objective of this specification is to provide information to assist with the application and use of MEG-Array® High Speed Mezzanine BGA (Ball Grid Array) connectors system. This specification is intended to provide general guidance for process development. It is recognized that no single process will work for all board assemblies and that customers will develop processes to meet their needs. However, if these processes differ greatly from the following recommendations, FCI cannot guarantee results.

2.0 SCOPE

This specification provides application guidelines and requirements regarding customer application of standard MEG-Array® BGA connectors with eutectic SnPb BGA and lead free SnAgCu, RoHS compliant BGA parts to printed circuit boards.

3.0 GENERAL

This document is meant to be an application guide. If there is conflict between the product drawings and specifications, the drawing takes precedence.

This specification consists of the following sections:

1.0	Objective.....	1
2.0	Scope.....	1
3.0	General.....	1
4.0	Product Drawings and Applicable Documents.....	1
5.0	Application Requirements.....	3-9
6.0	Application Tooling	9
7.0	Application Procedure.....	9-14
8.0	Post Application Inspection.....	14
9.0	Rework / Repair Tooling.....	14
10.0	Rework Procedure Guidelines.....	14-16
11.0	Additional Information.....	16-20
12.0	Revision Record.....	21

4.0 DRAWINGS AND APPLICABLE DOCUMENTS

Customer drawings and FCI Product Specification GS-12-100 are available on the FCI Interactive Product Catalog Web Site <http://12.30.8.43/fci/ss.asp?FAM=Meg-Array> or by calling Technical Service at 800-237-2374 (717-938-7212 from outside the USA). Customers are advised to refer to the latest revision of FCI customer drawings for appropriate details. In the event of a conflict between this document and the drawing or product specification, the drawing and product specification will take precedence. Table 1 describes available board stack heights and numbers of contact positions to assist with connector part number selection. For details on regulative compliance such as EU Directive and RoHS reference FCI specification GS-22-008.

	TYPE	APPLICATION SPECIFICATION		NUMBER	GS-20-033		
	TITLE	MEG-Array® High Speed Mezzanine Connectors			PAGE	2 of 21	REVISION
				AUTHORIZED BY	D. Horchler		11 Sept 13
				CLASSIFICATION	UNRESTRICTED		

Table 1: Connector Sizes and Stack Heights

Board-to-Board Height***							
Size	Type	4.0mm	6.0mm	8.0mm	10.0mm	12.0mm	14.0mm
81 position 9x9	Plug	55714 0mm					
	Receptacle	55715 4mm					
100 position 10x10	Plug	84512 0mm					
	Receptacle	84513 4mm					
200 position 10x20	Plug	84516 0mm	84516 0mm	84516 0mm	84530 6mm	84530 6mm	84530 6mm
	Receptacle	84517 4mm	55724 6mm	84535 8mm	84517 4mm	55724 6mm	84535 8mm
300 position 10x30	Plug	84500 0mm	84500 0mm	84500 0mm	84578 6mm	84578 6mm	84578 6mm
	Receptacle	84501 4mm	84502 * 5.5mm	84553 8mm	84501 4mm	84502 ** 5.5mm	84553 8mm
320 position 10x32	Plug	10123981 0mm					
	Receptacle	10123982 4mm					
400 position 10x40	Plug	84740 0mm	84740 0mm	84740 0mm	84520 6mm	84520 6mm	84520 6mm
	Receptacle	74221 4mm	74388 6mm	74390 8mm	74221 4mm	74388 6mm	74390 8mm
240 position 8x30	Plug	74213 0mm	74213 0mm				
	Receptacle	74217 4mm	55755 6mm				
528 position 12 x 44	Plug		10022617 0mm				
	Receptacle		10026846 6mm				

*P/N 84502 mated with P/N 84500 results in a 5.5mm mated height.

** P/N 84502 mated with P/N 84578 results in a 11.5mm mated height

***Mated board-to-board height is affected by PCB pad size, plating, solder paste and solder profile.

	TYPE	APPLICATION SPECIFICATION		NUMBER	GS-20-033		
	TITLE	MEG-Array® High Speed Mezzanine Connectors			PAGE	3 of 21	REVISION
				AUTHORIZED BY	D. Horchler		11 Sept 13
				CLASSIFICATION	UNRESTRICTED		

5.0 APPLICATION REQUIREMENTS

5.1 GENERAL PRODUCT FEATURES

MEG-Array® connectors are an effective solution for high density, high-speed mezzanine applications. The taller stack height connectors support 10Gb/s data rates with less than 1% cross-talk when configured differentially. 4mm and 6mm stack heights tested to 28Gb/s. The broad range of stack heights (4mm to 14mm in 2mm increments) and numbers of contacts (81 signals to 528 signals) provide design flexibility. The connector utilizes Ball Grid Array (BGA) for solder attachment to the PCB (See Figures 1A and 1B). Connectors are available in Eutectic SnPb or Lead Free 95.5Sn / 4Ag / 0.5Cu BGA. For initial alignment during connector engagement, the plug housing has a chamfered lead-in that captures and guides the receptacle housing. To assure proper mating orientation, plug connectors are keyed with a “large slot” at one end and a “small slot” at the other end, and the receptacle parts are keyed with a “large key” at one end and a “small key” at the other end. The A1 position is identified with a “Δ” at the end of the connector.

Connectors are supplied on tape and reel (See Figure 5) and a pick-up cap is standard for vacuum pick-and-place during automated assembly.

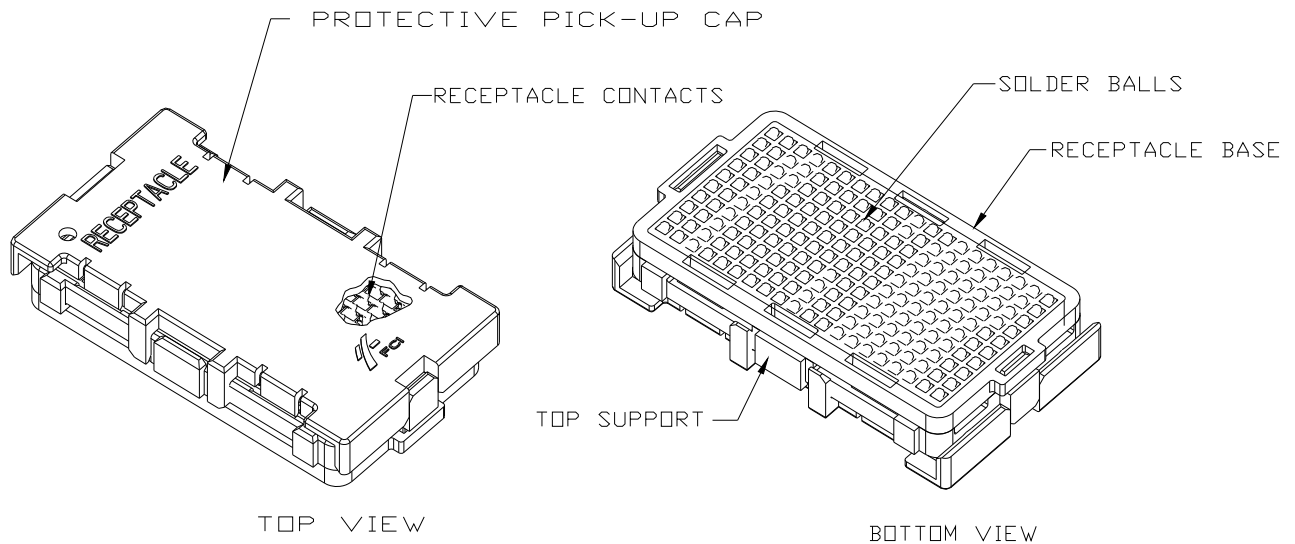

	TYPE	APPLICATION SPECIFICATION		NUMBER	GS-20-033		
	TITLE	MEG-Array® High Speed Mezzanine Connectors			PAGE	4 of 21	REVISION
				AUTHORIZED BY	D. Horchler		11 Sept 13
				CLASSIFICATION	UNRESTRICTED		

Figure 1A: Receptacle Connector Features

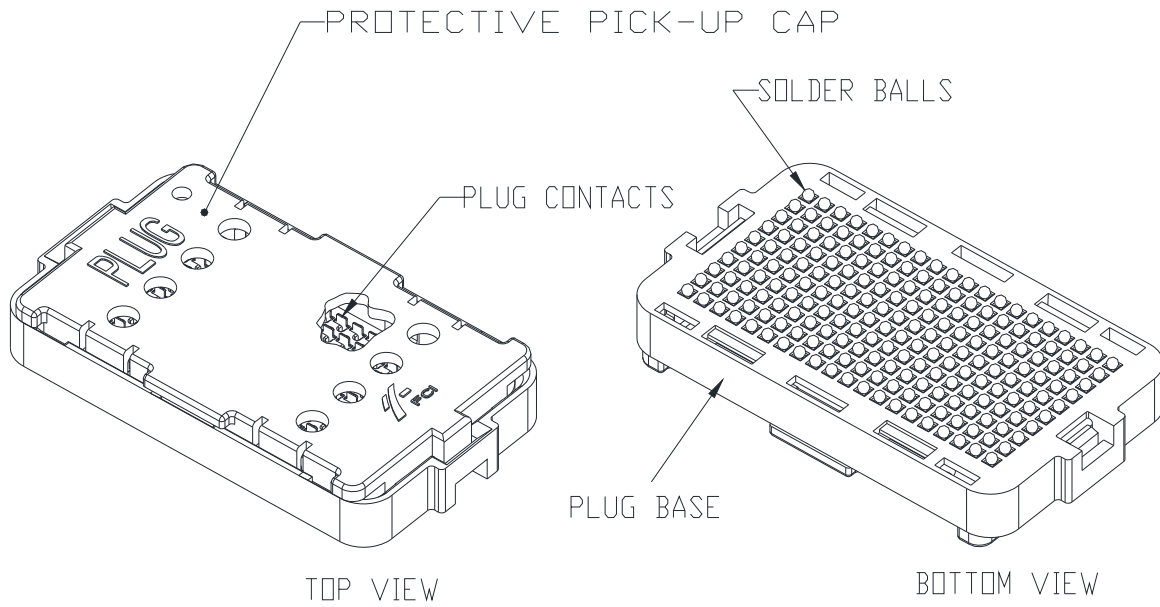

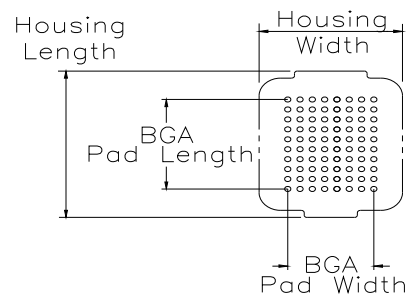

Figure 1B: Plug Connector Features

	TYPE	APPLICATION SPECIFICATION		NUMBER	GS-20-033		
	TITLE	MEG-Array® High Speed Mezzanine Connectors			PAGE	5 of 21	REVISION
				AUTHORIZED BY	D. Horchler		11 Sept 13
				CLASSIFICATION	UNRESTRICTED		

5.2 PRODUCT SIZES

Table 2 outlines the PCB area required for each of the MEG-Array connector sizes. Table 3 provides the connector heights, weights and weight/ball.



Feature Description	81 Position (9 x 9)	100 Position (10 x 10)	200 Position (10 x 20)	240 Position (8 x 30)	300 Position (10 x 30)	320 Position (10 x 32)	400 Position (10 x 40)	528 position (12 x 44)
Housing Length (mm)	17.43	18.70	31.40	42.30	44.10	46.64	56.80	61.88
Housing width (mm)	16.07	17.34	17.34	14.80	17.34	17.34	17.34	19.88
BGA/Pad Length (mm)	10.16	11.43	24.13	36.83	36.83	39.37	49.53	54.61
BGA/Pad Width (mm)	10.16	11.43	11.43	8.89	11.43	11.43	11.43	13.97

Table 2: Connector Size and Board Space Requirements



	TYPE	APPLICATION SPECIFICATION	NUMBER	GS-20-033		
	TITLE	MEG-Array® High Speed Mezzanine Connectors		PAGE	6 of 21	REVISION
			AUTHORIZED BY	D. Horchler	11 Sept 13	
			CLASSIFICATION	UNRESTRICTED		

Table 3: Connector Heights and Weights

Connector Heights and Weights							
Description	Base Part Number	With Pick-up Cover			W/Out Pick-up Cover		
		Height (mm)	Weight (grams)	Weight/ Ball (grams)	Height (mm)	Weight (grams)	Weight/ Ball (grams)
Plug (81 Positions, 0mm)	55714	4.91	1.15	0.014	3.89	0.74	0.009
Receptacle (81 Positions, 4mm)	55715	5.04	1.28	0.015	3.89	0.87	0.011
Plug (100 Positions, 0mm)	84512	4.91	1.37	0.014	3.89	0.94	0.009
Receptacle (100 Positions, 4mm)	84513	5.04	1.51	0.015	3.89	1.08	0.011
Plug (200 Positions, 0mm)	84516	4.91	2.41	0.012	3.89	1.66	0.008
Plug (200 Positions, 6mm)	84530	10.91	4.67	0.023	9.89	3.92	0.019
Receptacle (200 Positions, 4mm)	84517	5.04	2.67	0.013	3.89	1.92	0.009
Receptacle (200 Positions, 6mm)	55724	7.04	3.54	0.018	5.89	2.79	0.015
Receptacle (200 Positions, 8mm)	84535	9.04	3.97	0.020	7.89	3.22	0.016
Plug (240 Positions, 0mm)	74213	4.91	2.82	0.012	3.89	1.90	0.008
Receptacle (240 Positions, 4mm)	74217	5.04	3.08	0.013	3.89	2.16	0.009
Receptacle (240 Positions, 6mm)	55755	7.04	4.13	0.017	5.89	3.21	0.013
Plug (300 Positions, 0mm)	84500	4.91	3.44	0.011	3.89	2.38	0.008
Plug (300 Positions, 6mm)	84578	10.91	6.77	0.022	9.89	5.71	0.019
Receptacle (300 Positions, 4mm)	84501	5.04	3.83	0.013	3.89	2.77	0.009
Receptacle (300 Positions, 5.5mm)	84502	6.54	4.94	0.016	5.39	3.88	0.013
Receptacle (300 Positions, 8mm)	84553	9.04	5.74	0.019	7.89	4.68	0.015
Plug (320 Positions, 0mm)	10123981	4.91	3.67	0.011	3.89	2.54	0.008
Receptacle (320 Positions, 4mm)	10123982	5.04	4.08	0.013	3.89	2.95	0.009
Plug (400 Positions, 0mm)	84740	4.91	4.41	0.011	3.89	3.15	0.008
Plug (400 Positions, 6mm)	84520	10.91	8.51	0.021	9.89	7.25	0.018
Receptacle (400 Positions, 4mm)	74221	5.04	4.91	0.012	3.89	3.65	0.009
Receptacle (400 Positions, 6mm)	74388	7.04	6.61	0.016	5.89	5.35	0.013
Receptacle (400 Positions, 8mm)	74390	9.04	7.33	0.018	7.89	6.07	0.015
Plug (528 Positions, 0mm)	10022671	4.91	5.42	0.010	3.89	4.02	0.008
Receptacle (528 Positions, 6mm)	10026846	7.04	8.38	0.016	5.89	6.82	0.013

	TYPE	APPLICATION SPECIFICATION		NUMBER	GS-20-033		
	TITLE	MEG-Array® High Speed Mezzanine Connectors			PAGE	7 of 21	REVISION
				AUTHORIZED BY	D. Horchler		11 Sept 13
				CLASSIFICATION	UNRESTRICTED		

5.3 PCB DESIGN

Proper PCB design affects connector reliability and performance. The following recommendations are intended to ensure reliable electrical connections, while maximizing manufacturing yields and aiding in possible rework applications. Refer to customer drawings for overall pad layout. See Figure 2 for the detail of a single pad and via design.

- PCB pad diameter: 0.584 – 0.635 mm (.023 – .025 in.).
- Copper defined solder pads
- Pad materials: Copper with OSP or HASL
- Solder mask opening diameter must be greater than the PCB pad diameter and be registered properly so that 0.15 mm (.006 in.) minimum clearance is met all around the pad.
- PCB vias should not be included in the ball grid array solder pads (See Figure 2). The connector side of the via shall be fully covered with solder mask. Solder mask may be truncated along interconnect trace.
- Keep out area around the part perimeter, 5.10 mm (.201in.), is generally recommended for clearance of rework equipment. Consult with equipment manufacturers for recommended clearance specifics.

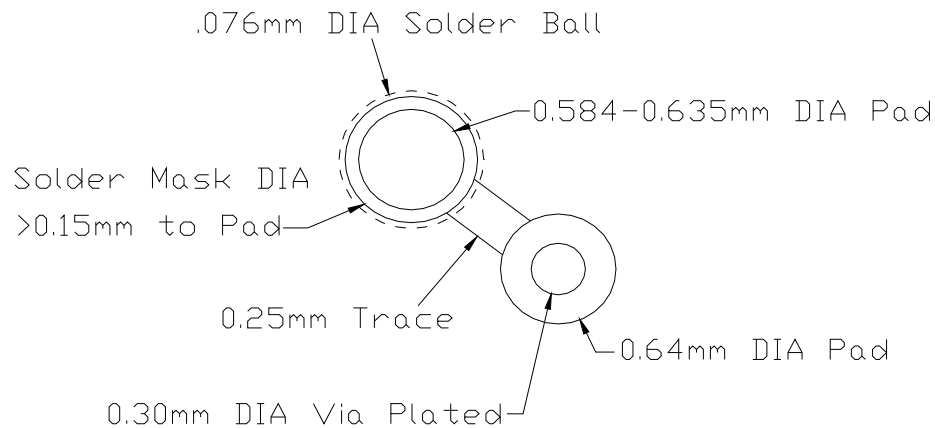



Figure 2: Pad Layout Example

	TYPE APPLICATION SPECIFICATION	NUMBER GS-20-033	
TITLE MEG-Array® High Speed Mezzanine Connectors		PAGE 8 of 21	REVISION H
		AUTHORIZED BY D. Horchler	11 Sept 13
CLASSIFICATION UNRESTRICTED			

5.3.1 Multiple Connector Applications

When designing for multiple mating applications, the ball grid array patterns shall be within +/-0.05 true position relative to each other (Connector to connector final location tolerance +/-0.1mm.). It is recommended that multiple connectors be parallel to each other or in the same orientation as shown in Figure 3. Orientation as shown in Figure 4 is not recommended. Proper connector orientation will aid compliance with the recommended connector mating and un-mating procedures that are described in section 11.2.

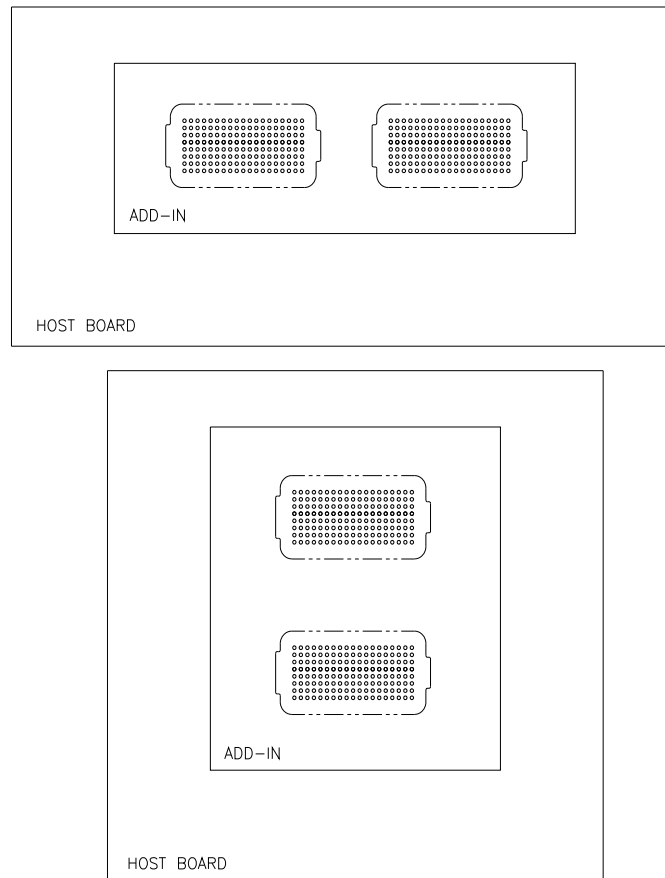



Figure 3: Recommended Orientation for Multiple Pairs

	TYPE	APPLICATION SPECIFICATION		NUMBER	GS-20-033	
	TITLE	MEG-Array® High Speed Mezzanine Connectors		PAGE	9 of 21	REVISION
				AUTHORIZED BY	D. Horchler	11 Sept 13
				CLASSIFICATION	UNRESTRICTED	

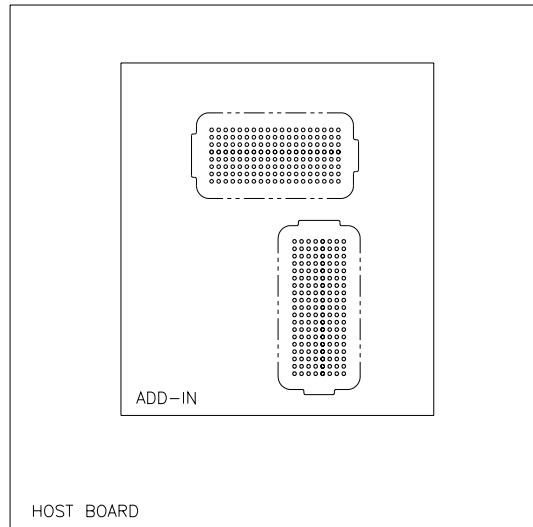

Figure 4: NOT Recommended unless eventual mating with another PCB is done vertically (without zippering)

6.0 APPLICATION TOOLING

Connector placement and assembly to PCB does not require any special tooling. However, depending upon a user's process, application specific tooling may be required.

7.0 APPLICATION PROCEDURE

IPC-A-610 defines specific criteria for Acceptable Electronic Assembly. Section 8.2.12 defines Surface Mount Area Array processing. Final Assembly must meet the acceptable industry criteria for SMT processing.

7.1 CONNECTOR PLACEMENT

- Connectors are packaged and shipped in anti-static plastic tape pockets, as shown in Figure 5. For additional information on connectors and tape, see Table 4. Reel diameter is 330mm.
- The pick-up cap, attached to the housing can be used for vacuum pick-up and placement with automated equipment. Placement by hand or with mechanical grippers that grip the outside of the connector housing will also work.
- Connector shall be placed so that solder balls are placed on top of or lightly pushed into the solder paste. Connector shall not be dragged into place, since this will track solder paste that may cause bridging and result in an electrical short.
- Connector placement utilizes typical BGA placement procedures.

	TYPE	APPLICATION SPECIFICATION		NUMBER	GS-20-033		
	TITLE	MEG-Array® High Speed Mezzanine Connectors			PAGE	10 of 21	REVISION
				AUTHORIZED BY	D. Horchler		11 Sept 13
				CLASSIFICATION	UNRESTRICTED		

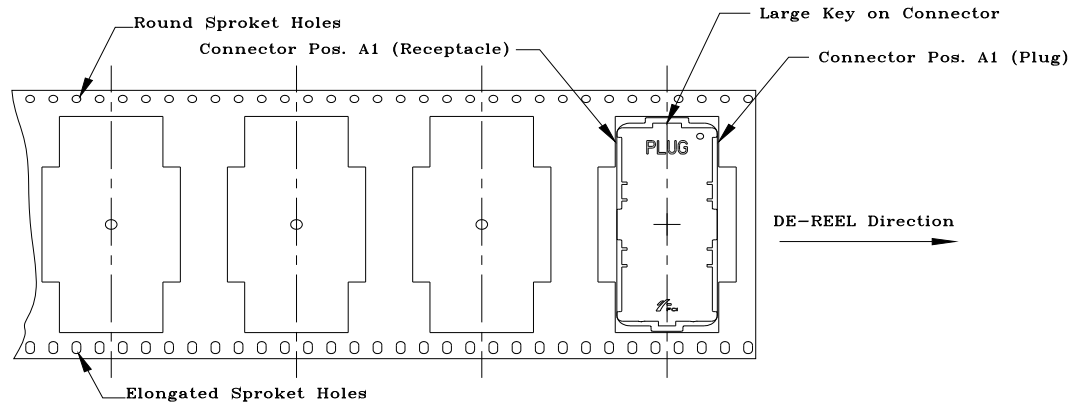

TAPE & REEL PACKAGING
PER EIA-481-B

Figure 5: Tape-and-Reel Configuration (Plug Shown)

	TYPE	APPLICATION SPECIFICATION	NUMBER	GS-20-033
	TITLE		PAGE	REVISION
MEG-Array® High Speed Mezzanine Connectors			11 of 21	H
			AUTHORIZED BY	11 Sept 13
			D. Horchler	
			CLASSIFICATION	UNRESTRICTED

Tape and Reel Dimensions & Reel Quantities					
Description	Base Part Number	Carrier Tape Width	Tape Pocket Pitch	Tape Pocket Depth	Quantity Per Reel
Plug (81 Positions, 0mm)	55714	32mm	28mm	5.69	250
Receptacle (81 Positions, 4mm)	55715	32mm	28mm	5.79	250
Plug (100 Positions, 0mm)	84512	32mm	28mm	5.65	250
Receptacle (100 Positions, 4mm)	84513	32mm	28mm	5.80	250
Plug (200 Positions, 0mm)	84516	44mm	32mm	5.42	250
Plug (200 Positions, 6mm)	84530	44mm	28mm	11.50	150
Receptacle (200 Positions, 4mm)	84517	44mm	28mm	5.75	250
Receptacle (200 Positions, 6mm)	55724	44mm	28mm	6.90	200
Receptacle (200 Positions, 8mm)	84535	44mm	32mm	9.55	150
Plug (240 Positions, 0mm)	74213	56mm	24mm	5.65	300
Receptacle (240 Positions, 4mm)	74217	56mm	24mm	6.13	300
Receptacle (240 Positions, 6mm)	55755	56mm	28mm	6.95	250
Plug (300 Positions, 0mm)	84500	56mm	32mm	5.65	250
Plug (300 Positions, 6mm)	84578	72mm	32mm	10.46	150
Receptacle (300 Positions, 4mm)	84501	56mm	28mm	5.75	250
Receptacle (300 Positions, 5.5mm)	84502	56mm	28mm	7.18	200
Receptacle (300 Positions, 8mm)	84553	56mm	28mm	9.75	150
Plug (320 Position, 0mm)	10123981	56mm	32mm	5.65	250
Receptacle (320 Positions, 4mm)	10123982	56mm	28mm	5.75	250
Plug (400 Positions, 0mm)	84740	72mm	28mm	5.91	250
Plug (400 Positions, 6mm)	84520	72mm	32mm	12.13	150
Receptacle (400 Positions, 4mm)	74221	72mm	28mm	6.05	250
Receptacle (400 Positions, 6mm)	74388	72mm	28mm	7.82	250
Receptacle (400 Positions, 8mm)	74390	72mm	28mm	9.90	200
Plug (528 Positions, 0mm)	10022671	88mm	28mm	5.91	250
Receptacle (528 Positions, 6mm)	10026846	88mm	28mm	7.82	250

Table 4: Tape and Reel Information

	TYPE	APPLICATION SPECIFICATION		NUMBER	GS-20-033	
	TITLE	MEG-Array® High Speed Mezzanine Connectors		PAGE	12 of 21	REVISION
				AUTHORIZED BY	D. Horchler	11 Sept 13
				CLASSIFICATION	UNRESTRICTED	

7.2 SOLDER PASTE & DEPOSITION

- For ease of use, a no-clean solder paste is recommended.
- Eutectic SnPb solder paste is required for standard product.
- 95.5Sn /4Ag /0.5Cu solder paste is recommended for Lead Free RoHS product.
- Recommended stencil thickness is 0.127 – 0.152 mm (.005 - .006 inch).
- Recommend a round aperture diameter of 0.66 mm (for 0.127 mm thick stencil) or 0.61 mm (for 0.152mm thick stencil). These combinations give paste volume of approximately 0.044 mm³ (2.68E-6 inch³).

7.3 SOLDER REFLOW

- All recommended temperatures are on top surface of the board within or near the connector ball grid array.

For Standard connectors using Eutectic SnPb solder paste:

- To obtain temperature equalization at all the BGA locations, soak at 130°C to 160°C prior to reflow for 120 seconds max.
- Reflow time above 183°C should be between 1 to 2 minutes.
- Peak temperature should be between 210°C and 225°C.
- The maximum temperature on the board should not exceed 230°C for more than 10 seconds.
- The maximum total cumulative time to ramp up, soak, and reflow the board shall be limited to 330 seconds.
- Nitrogen environment of equal to or greater than 4,000 ppm O₂ can improve solderability, but is not required.
- Maximum ramp rate should be < 3°C per second.
- See Figure 6 for example profile.

For Lead Free RoHS product:

- To obtain temperature equalization at all the BGA locations, soak at 150°C to 210°C prior to reflow for 60-90 seconds typical.
- Reflow time above 219°C should be a maximum of 90 seconds.
- Peak temperature should be between 230°C and 260°C.
- The maximum temperature on the board should not exceed 260°C for more than 10 seconds.
- The maximum total cumulative time to ramp up, soak, and reflow the board shall be limited to 330 seconds.
- Nitrogen environment of equal to or greater than 4,000 ppm O₂ can improve solderability, but is not required.
- Maximum ramp rate should be < 2.5°C per second.

	TYPE	APPLICATION SPECIFICATION		NUMBER	GS-20-033		
	TITLE	MEG-Array® High Speed Mezzanine Connectors			PAGE	13 of 21	REVISION
				AUTHORIZED BY	D. Horchler		11 Sept 13
				CLASSIFICATION	UNRESTRICTED		

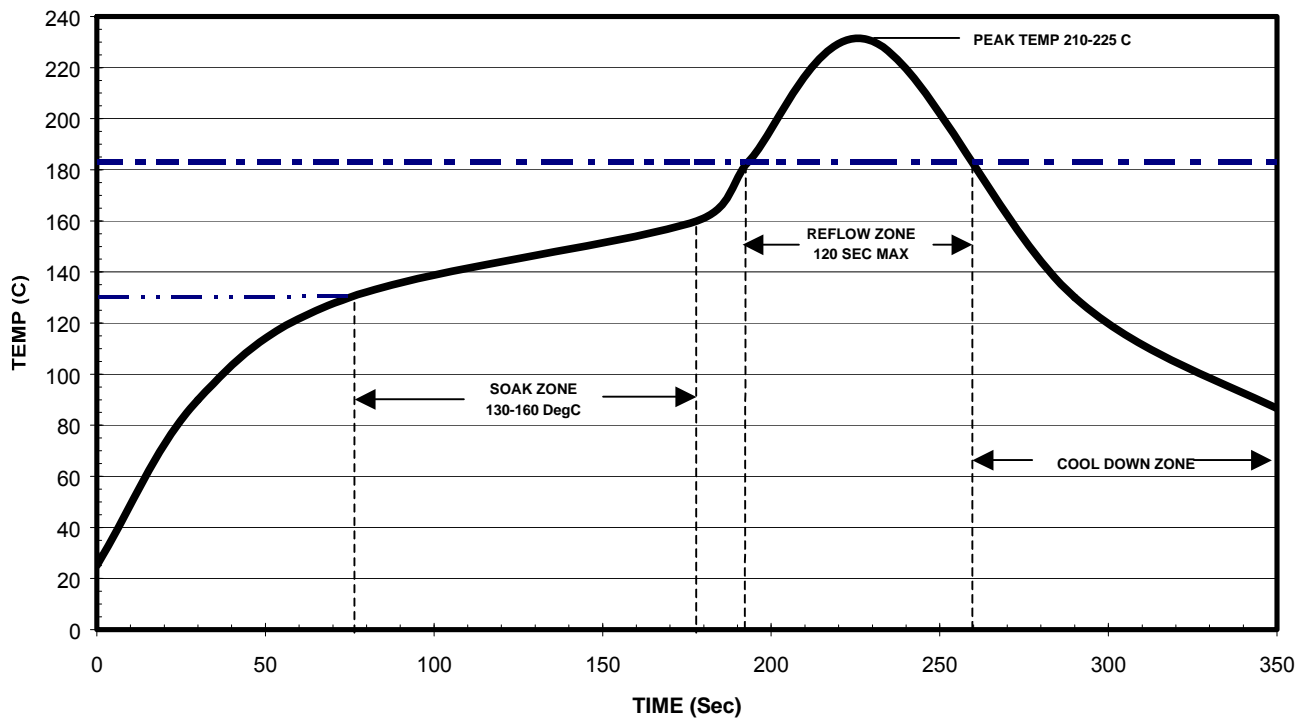



Figure 6: Eutectic SnPb Solder Profile

	TYPE	APPLICATION SPECIFICATION		NUMBER	GS-20-033
	TITLE	MEG-Array® High Speed Mezzanine Connectors			PAGE
				AUTHORIZED BY	D. Horchler
				REVISION	H
				CLASSIFICATION	UNRESTRICTED

7.4 DOUBLE-SIDED REFLOW

All MEG-Array® connector sizes are suitable for double-sided reflow (DSR). See Table 3 for individual connector weights. In all cases, users should verify connector applicability for inverted reflow through process verification testing.

7.5 CLEANING

If desired, following reflow the connector and board assembly can be washed with an appropriate cleaner to remove any residue or contaminants. Vacuum pickup caps should be removed prior to cleaning to reduce the chance of trapping cleaning solutions.

8.0 POST APPLICATION INSPECTION

- Visually inspect the connector for damage and cleanliness.
- Solder joints can be inspected with X-ray techniques that are typical to BGA components.
- Electrical testing can be performed with a customer-designed system. Caution must be taken to avoid damage to the connector terminals during electrical testing.

9.0 REWORK / REPAIR TOOLING

Naturally, prevention of defects is preferred to rework. Rework can be avoided through good process control, such as proper equipment setup and maintenance, in-process inspection, SPC use, and adequate operator training. The following rework procedure was developed using an SRT Summit 1100 rework station and a Pinnacle Scavenger to remove residual solder once the connector is removed. Other rework equipment would follow a similar procedure and would only need to be modified according to the equipment manufacturers recommendations.

10.0 REWORK PROCEDURE: In the event that rework is required, the following guidelines are general for eutectic solder applications. Adjust the temperatures accordingly for lead free applications. Consult and follow all equipment manufactures recommendations.

Step 1: Develop the Thermal Process

To develop the thermal process, a thermocouple should be attached next to the outer row of solder balls or preferably under the connector. Using the reflow nozzle as shown in the photograph, heat the connector by ramping the temperature from 25° C to 150° C with a maximum slope of 3° C per second. Soak at 130° C to 160° C for two minutes maximum. Depending upon thermocouple placement, re-flow for 1 to 2 minutes with a peak temperature of 210° C to 225° C, ensuring that the center solder locations reflow. Cool to 50° C with a maximum ramp of 3° per second.

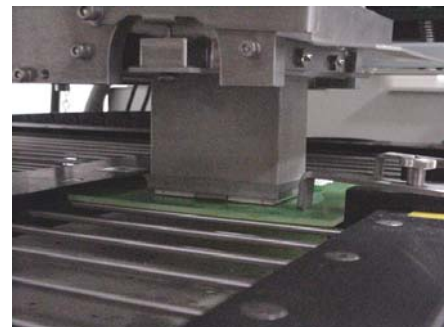

Reflow Nozzle

	TYPE	APPLICATION SPECIFICATION		NUMBER	GS-20-033		
	TITLE	MEG-Array® High Speed Mezzanine Connectors			PAGE	15 of 21	REVISION
				AUTHORIZED BY	D. Horchler		11 Sept 13
				CLASSIFICATION	UNRESTRICTED		

REWORK PROCEDURE GUIDELINES (CONT.)

Step 2: Remove the Connector

First, slide a metal rework clip, similar to the one shown in Figure 7, in place. Then use the thermal profile developed in step 1 to reflow the solder. A few seconds after the solder has reflowed, a vacuum pickup, which has a rubber tip, automatically moves to the correct location and removes the connector. The connector that is removed cannot be reused and should therefore be discarded after the solder has solidified. Since the majority of the solder is left on the printed circuit board, the residual solder must be cleaned prior to the reinstallation of a new connector.

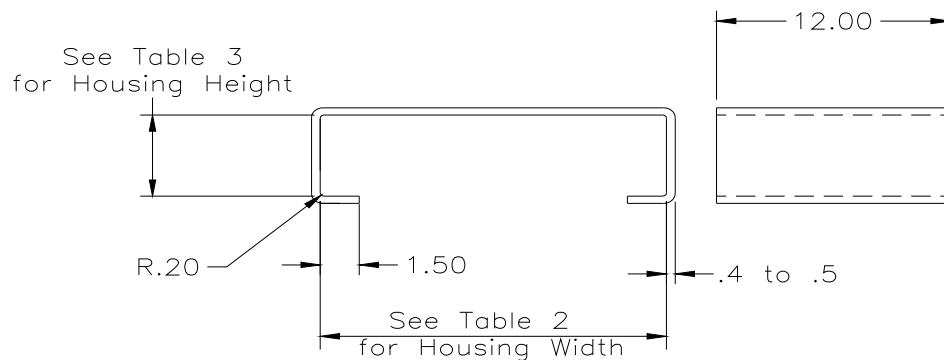



Figure 7: Rework Clip
Dimensions are in MM

	TYPE	APPLICATION SPECIFICATION		NUMBER	GS-20-033	
	TITLE	MEG-Array® High Speed Mezzanine Connectors		PAGE	16 of 21	REVISION
				AUTHORIZED BY	D. Horchler	11 Sept 13
				CLASSIFICATION	UNRESTRICTED	

Step 3: Board Cleaning and Preparation

Flux should be applied over the pads and residual solder. This will help in reactivating the solder and cleaning the pads. A solder scavenging system, which uses a hot gas non-contact nozzle to vacuum remove the solder, is recommended. The nozzle should be programmed to a scavenging height of approximately 0.2 mm (0.008") with a pre-programmed path that follows the MEG-Array® PCB pad layout and limits excess heating to other areas of the board. If a solder scavenging system is not available or is impractical, then a skilled operator can use other hand desoldering methods, though extra care must be taken to limit localized heating which could damage the PCB. After removal of the old residual solder, isopropyl alcohol can be used to clean up any excess flux or debris.

Step 4: Connector Replacement

After cleaning, it is recommended to repaste the pads using an 0.127 – 0.152 mm (.005-.006 inch) thick stencil to apply approximately 0.044 mm³ (2.68E-6 inch³) of solder paste. To assist in aligning the connector to the PCB pads, place a mark at the center of the long side of the housing. If the PCB does not have a silk-screened mark at the center pad location, hand mark the board, so that the center of the connector and the center of the pad layout align. Apply the metal clip used to remove the connector in step 2, to the new replacement connector. Then, with the metal clip in place, load and secure the connector into the vacuum pick-up system. The SRT Summit 1100 uses a split prism vision system to allow for the operator to simultaneously view the bottom of the connector and the top of the PCB. Align the PCB and connector center marks and place the connector. Once the connector is placed onto the board, reflow the solder using the established auto profile parameters. Remove the metal clip and reinspect and retest the connector as applicable.

11.0 ADDITIONAL INFORMATION:

11.1 STANDOFFS:

Application of MEG-Array® Connectors does not require the use of mechanical standoffs, however, using them in blind-mate applications is recommended. Benefits from using standoffs are rough alignment prior to mating, robust mechanical attachment of stacked boards, and isolation of connectors from mechanical stresses.

The stack height information provided in Table 1 is based on a specific PCB construction, reflow process, stencil size, & paste type. Solder sphere collapse will vary with changes to these parameters. Therefore, it is always best practice for the user to verify minimum and maximum stack heights post reflow (via cross-sections) using the exact PCB, reflow parameters, stencil size, and paste that will be used for a specific board assembly. This study will determine the minimum standoff shoulder height for the application. It is recommended that the connectors are not over mated such that they are in a compressed condition. See Figure 8.

	TYPE APPLICATION SPECIFICATION	NUMBER GS-20-033	
TITLE MEG-Array® High Speed Mezzanine Connectors	PAGE 17 of 21	REVISION H	
	AUTHORIZED BY D. Horchler	11 Sept 13	
CLASSIFICATION UNRESTRICTED			

Stand-off Height (to shoulder) to be Larger than maximum measured PCB to PCB collapse height of chosen MEG-Array® Connector System

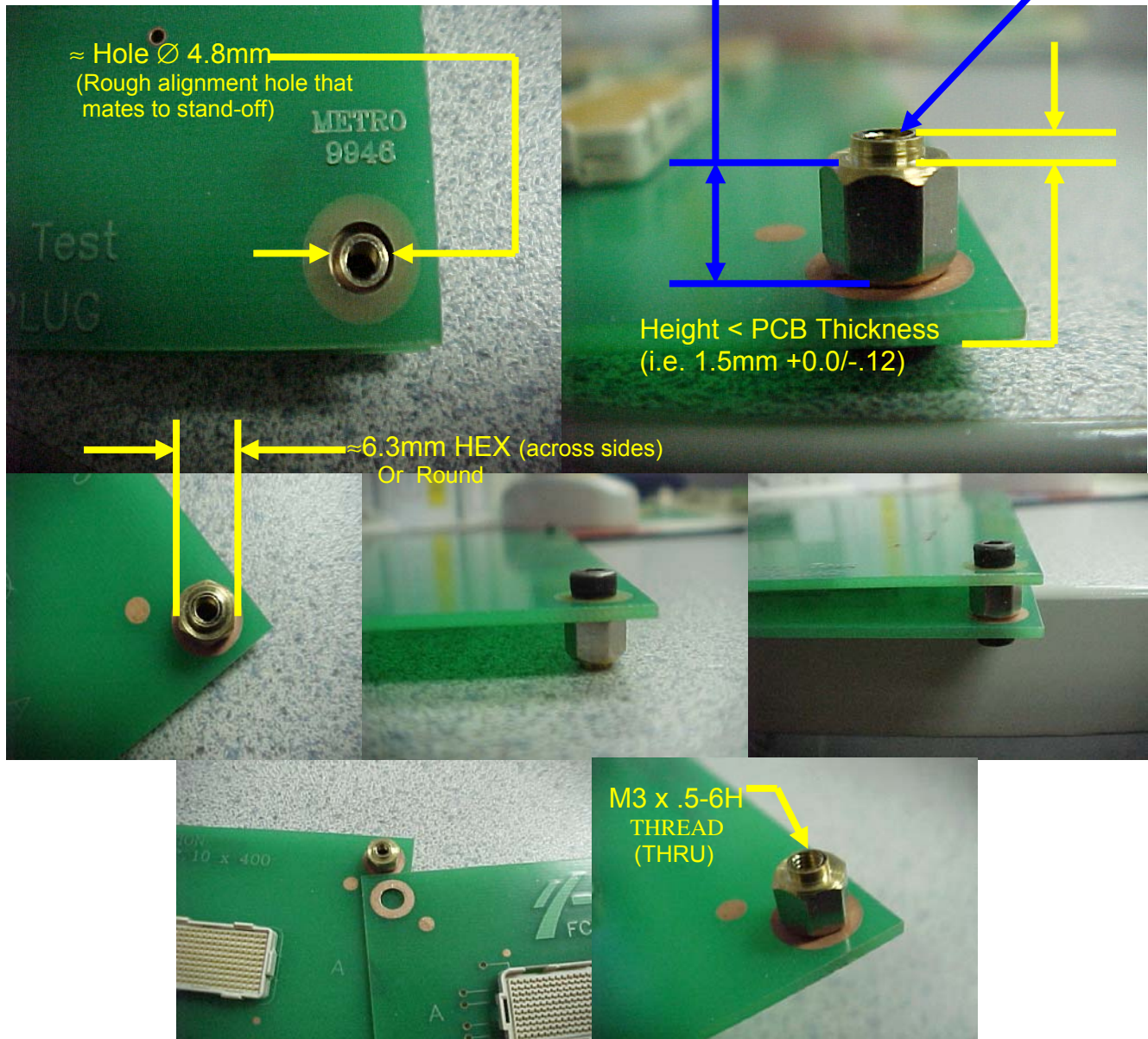



Figure 8: Stand-off Detail

	TYPE APPLICATION SPECIFICATION	NUMBER GS-20-033	
TITLE MEG-Array® High Speed Mezzanine Connectors		PAGE 18 of 21	REVISION H
		AUTHORIZED BY D. Horchler	11 Sept 13
CLASSIFICATION UNRESTRICTED			

11.2 RECOMMENDED MATING / UNMATING METHODS:

The MEG-Array® connectors can be mated straight (Figure 9), however, when mating a large pin count connector, like the 400 position MEG-Array® connector, less effort is required if you roll-mate the two-connector halves together as shown in Figure 10.

A part can be started from either end. Locate and match the connector's A1 position marking ("Δ") for both the Plug and Receptacle. (Markings are located on the long side of the housing.) Rough alignment is required prior to connector mating as misalignment of >0.8mm could damage connector contacts. Rough alignment of the connector is achieved through matching the Small alignment slot of the plug housing with the Small alignment key of the receptacle housing and the Large alignment slot with the Large alignment key. Both connector housings have generous lead-in around the perimeter and will allow the user to blind mate assemble the connectors. Align the two connectors by feel and when the receptacle keys start into the plug slots, push down on one end and then move force forward until the receptacle cover flange bottoms on the front face of the plug.

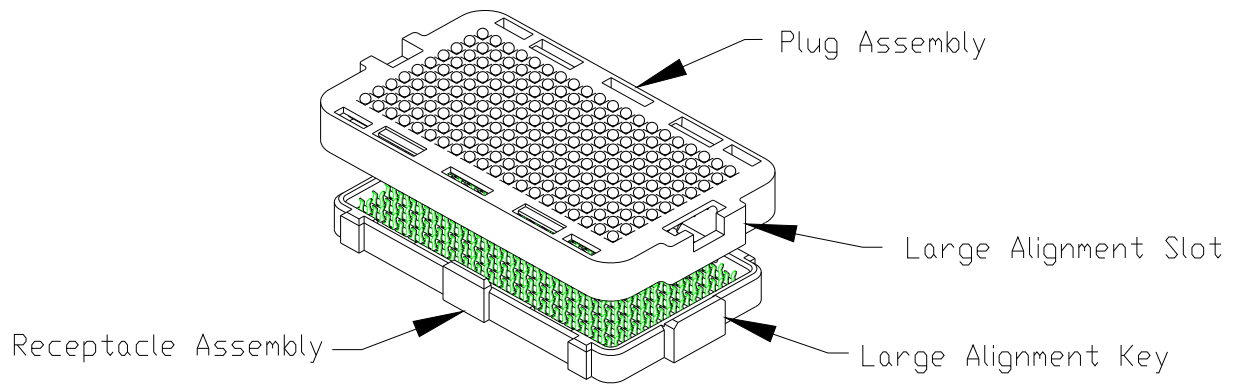



Figure 9: Recommended Mating

	TYPE	APPLICATION SPECIFICATION		NUMBER	GS-20-033		
	TITLE	MEG-Array® High Speed Mezzanine Connectors			PAGE	19 of 21	REVISION
				AUTHORIZED BY	D. Horchler		11 Sept 13
				CLASSIFICATION	UNRESTRICTED		

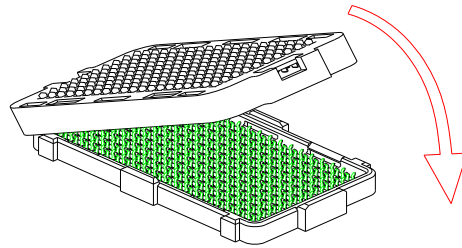

Figure 10: Recommended Mating

Like mating, a connector pair can be unmated by pulling them straight apart (See Figure 9). However, it requires less effort to un-mate if the force is originated from one of the slot/key ends of the assembly. (Reverse procedure from mating, see Figure 11.) Mating or un-mating of the connector by rolling in a direction perpendicular to alignment slots/keys may cause damage to the terminal contacts and is not recommended, see Figure 12.

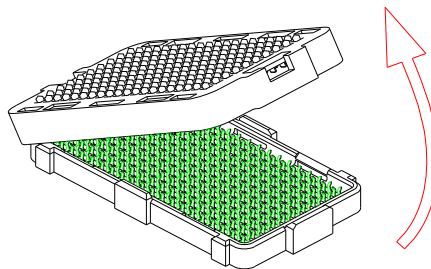



Figure 11: Recommended Un-Mating

	TYPE APPLICATION SPECIFICATION	NUMBER GS-20-033	
TITLE MEG-Array® High Speed Mezzanine Connectors		PAGE 20 of 21	REVISION H
		AUTHORIZED BY D. Horchler	11 Sept 13
CLASSIFICATION UNRESTRICTED			

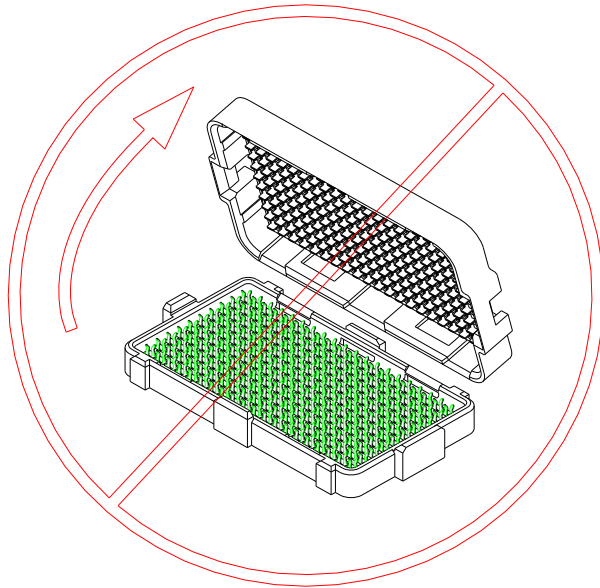



Figure 12: Not Recommended

	TYPE	APPLICATION SPECIFICATION		NUMBER	GS-20-033		
	TITLE	MEG-Array® High Speed Mezzanine Connectors			PAGE	21 of 21	REVISION
				AUTHORIZED BY	D. Horchler		11 Sept 13
				CLASSIFICATION	UNRESTRICTED		

11.3 GUIDELINES FOR FLEXIBLE CIRCUIT FABRICATION AND ASSEMBLY

The MEG-Array® connectors can be assembled to Flexible Circuits to provide high density cable solutions. When using the MEG-Array® connector with Flex Circuits it is required that IPC-6012 and IPC-6013 are followed to ensure quality and reliable performance. Class 1 shall apply to standard product (-0XX / -0XXLF / -1XX / -1XXLF) and Class 3 shall apply to Telcordia product (-2XX / -2XXLF).

12.0 REVISION RECORD

REV	PAGE	DESCRIPTION	EC #	DATE
A	All	Initial Release of Application Specification	V03-0303	3/12/2003
B	All	Add 528 Position Stack Height	V03-1244	11/19/03
C	All	Added information for Lead Free BGA / RoHS processing	V04-0884	10/25/04
D	13	Correction with reflow temp	V04-1142	11/22/04
E	All	Change logo	V06-0539	06/05/06
F	9, 16, 21	Add 11.3 Flex circuit standards and 7.0 regarding applicable Industry specification for SMT processing, 11.1 Over mate details	V10-0075	02/12/10
G	9	Revise FIGURE 4 caption	V-008843	12/15/11
H	Several	Add 320 position size	V-15819	9/11/2013