

SEAF-XX-XX.X-XX-XX-X-A-XX-K-TR

DO NOT SCALE FROM THIS PRINT

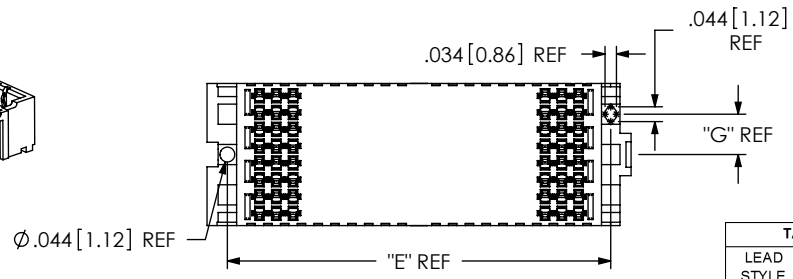
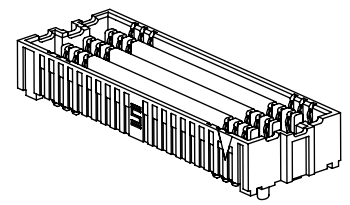
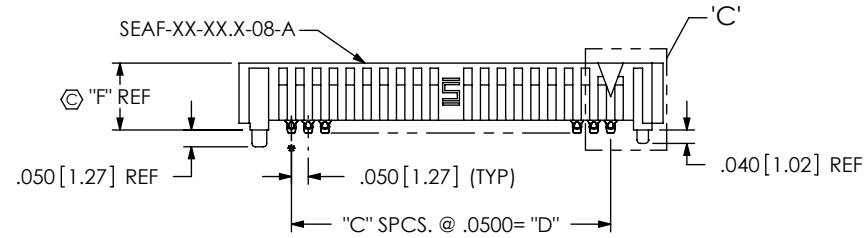
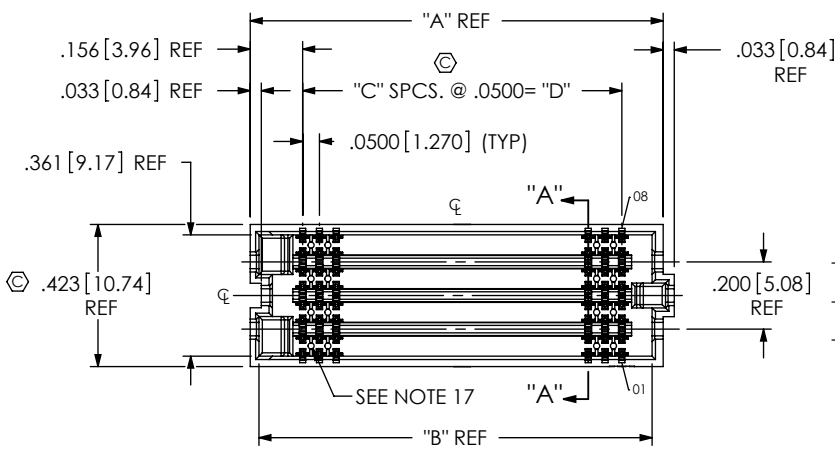

FIG 1
-08: 8 ROW
(SEAF-20-05.0-XX-08-1-A-XX-K-TR SHOWN)
(SOME CENTER FEATURES REMOVED FOR CLARITY)

No OF POSITIONS
 □ -10, ☒ -15, ** -19, -20
 ▽ -25, -30, -40, -50
 (PER ROW)
 LEAD STYLE
 -05.0: .199 [5.05] HEIGHT
 -06.0: .238 [6.05] HEIGHT
 -06.5: .258 [6.55] HEIGHT
 *** -07.5: .297 [7.54] HEIGHT
 (SEE TABLE 1)

PLATING SPECIFICATION
 -S: SELECTIVE GOLD (30μ") IN CONTACT AREA, MATTE TIN ON TAIL (USE NEW-SUB-C-209-XX.X-S-X)
 -L: LIGHT GOLD (10μ") IN CONTACT AREA, MATTE TIN ON TAIL (USE NEW-SUB-C-209-XX.X-L-X)
 -SM: SELECTIVE GOLD (30μ") IN CONTACT AREA, MATTE TIN ON TAIL (USE NEW-SUB-C-209-XX.X-S-X)

ROWS
 -04: 4 ROWS (SEE SHT 5, FIG 11)
 -05: 5 ROWS (SEE SHT 3, FIG 5) (SEE NOTE 18)
 -06: 6 ROWS (SEE SHT 3, FIG 4)
 -08: 8 ROWS (SEE SHT 1, FIG 1)
 -10: 10 ROWS (SEE SHT 2, FIG 2)

* = NOT TOOLED
 □ = 10 POSITION ONLY AVAILABLE IN 4 ROW.
 ☒ = ONLY AVAILABLE WITH -05.0 BODY HEIGHT, -10 ROW.
 ▽ = ONLY AVAILABLE WITH -05.0 AND -06.5 BODY HEIGHT AND 4 ROW.
 ** = ONLY AVAILABLE WITH -06.5 BODY HEIGHT, AND -06 ROW.
 *** = ONLY AVAILABLE WITH 30 POS & 4 ROW.
 **** = ONLY AVAILABLE WITH -05.0 BODY HEIGHT, -04, -06, -08 & -10 ROW.
 ***** = NOT RELEASED FOR PRODUCTION.

K-DOT (SEE SHT 2, FIG 3) (SEE NOTE 7)
 OPTION
 ****-LP: LATCH POST OPTION (SEE SHT 4, FIG 8) (ONLY AVAILABLE WITH -05.0 LEAD STYLE, -04, -06, -08 & -10 ROW) (-K OPTION NOT AVAILABLE ON -10 OR -15 POSITION)
 *****-RP: RETENTION PIN (SEE SHT 4, FIG 9) (ONLY AVAILABLE WITH -05.0 LEAD STYLE, 6, 8 & 10 ROWS)
 -PP: POLARIZATION PIN (SEE SHT 4, FIG 10) (ONLY AVAILABLE WITH -05.0 LEAD STYLE, 6, 8 & 10 ROWS)
 ALIGNMENT PINS (SEE NOTES 6, 12 & 14)

SOLDER COMPOSITION & STYLE
 -1: 63% TIN / 37% LEAD
CHARGE TAIL
 (USE NEW-SUB-C-209-XX.X-X-7)
 -2: 95.5% TIN/3.8% SILVER/.7% COPPER
CHARGE TAIL
 (USE NEW-SUB-C-209-XX.X-X-2)

No OF POS.	"A"	"B"	"C"	"D"	"E"
□ -10	.729 [18.52]	.670 [17.02]	9	.4500 [11.430]	.6410 [16.281]
☒ -15	.979 [24.87]	.920 [23.37]	14	.7000 [17.780]	.8910 [22.631]
** -19	1.179 [29.95]	1.120 [28.45]	18	.9000 [22.860]	1.0910 [27.711]
-20	1.229 [31.22]	1.170 [29.72]	19	.9500 [24.130]	1.1410 [28.981]
▽ -25	1.479 [37.57]	1.420 [36.07]	24	1.2000 [30.480]	1.3910 [35.331]
-30	1.729 [43.92]	1.670 [42.42]	29	1.4500 [36.830]	1.6410 [41.681]
-40	2.229 [56.62]	2.170 [55.12]	39	1.9500 [49.530]	2.1410 [54.381]
-50	2.729 [69.32]	2.670 [67.82]	49	2.4500 [62.230]	2.6410 [67.081]

LEAD STYLE	"F"
-05.0	.199 [5.05]
-06.0	.238 [6.05]
-06.5	.258 [6.55]
***-07.5	.297 [7.54]

No OF ROWS	"G"
-04	.079 [2.01]
-05	.120 [3.05]
-06	.120 [3.05]
-08	.120 [3.05]
-10	.120 [3.05]

LEAD STYLE	BODY CALLOUT	CONTACT
		SOLDER CHARGE TAIL
-05.0	SEAF-XX05.0-XX-X	NEW-SUB-C-209-05.0-X-X
-06.0	SEAF-XX06.0-XX-X	NEW-SUB-C-209-06.0-X-X
-06.5	SEAF-XX06.5-XX-X	NEW-SUB-C-209-06.5-X-X
***-07.5	SEAF-XX07.5-XX-X	NEW-SUB-C-209-07.5-X-X

SEAF LEAD STYLE	STACK HEIGHT							
	SEAM LEAD STYLE							
	-02.0	-03.0	-03.5	-06.5	-07.0	-09.0	-11.0	* -13.0
-05.0	7mm	8mm	8.5mm	11.5mm	12mm	14mm	16mm	18mm
-06.0	8mm	9mm	9.5mm	12.5mm	13mm	15mm	17mm	19mm
-06.5	8.5mm	9.5mm	10mm	13mm	13.5mm	15.5mm	17.5mm	19.5mm
***-07.5	9.5mm	10.5mm	11mm	14mm	14.5mm	16.5mm	18.5mm	20.5mm

- NOTES:
- ⊙ REPRESENTS A CRITICAL DIMENSION.
 - MINIMUM PUSHOUT FORCE: 0.50 LBS.
 - NOTE DELETED.
 - 5 ROW SOLDER TAILS ARE NOT SYMMETRICAL WITH BODY WIDTH - DIM .321 [8.15]. (SEE SHEET 3, FIG. 5).
 - WHEN APPLICABLE, DIMENSION C12 MUST BE MEASURED USING INSPECTION FIXTURE AT-1817-836-1 FOR -04 ROW, OR AT-1817-836-2 FOR -06, -08 & -10 ROW. USE CO-AU-WI-2003-M FOR PROCESS.
 - WITHOUT -A, AVAILABLE FOR EXISTING CUSTOMERS ONLY AS OF REVISION Y.
 - K-DOT WILL BE SUPPLIED WHETHER OR NOT -K IS SPECIFIED.
 - TAPE & REEL WILL BE SUPPLIED WHETHER OR NOT -TR IS SPECIFIED.
 - FOR QUANTITIES UP TO 49 PIECES, NO LEADER, TRAILER, OR REEL WILL BE SUPPLIED.
 - FOR QUANTITIES OF 50 - 124 PIECES, NO LEADER OR TRAILER WILL BE SUPPLIED. SPLICES MAY BE PRESENT.
 - ATTACH LABEL "SEAX-0001" TO EACH TAPE & REEL PACKAGE.
 - SOLDER CHARGE VOLUME IS .00000891 CUBIC INCHES (REF).
 - FOR VITA REQUIREMENTS, -A PIN SHOULD NOT BE ORDERED.
 - SLOT ORIENTATION MUST BE AS SHOWN.
 - A-PINS STANDARD ON ALL BODIES, EXCEPT 6 x 19. SEE SHEET 1, FIG. 1
 - A-PINS ARE OPTIONAL ON 6 x 19. SEE SHEET 4, FIG. 7
 - MAXIMUM ROW TO ROW VARIATION .003 [0.08], MEASURED FIRST & LAST POSITIONS ONLY, ALL ROWS.
 - NOTE DELETED.
 - NON-FUNCTIONAL VOIDING IN PLASTIC BODY TO BE AT SAMTEC'S DISCRETION.
 - THESE OPTIONS AVAILABLE AS ASO (APPLICATION SPECIFIC OPTIONS) ONLY. PLEASE CONTACT SAMTEC FOR MORE INFORMATION.

UNLESS OTHERWISE SPECIFIED, DIMENSIONS ARE IN INCHES.
 TOLERANCES ARE:
 DECIMALS ANGLES
 .XX: ±.01 [.3] 2°
 .XXX: ±.005 [.13]
 .XXXX: ±.0020 [.051]

PROPRIETARY NOTE
 THIS DOCUMENT CONTAINS INFORMATION CONFIDENTIAL AND PROPRIETARY TO SAMTEC, INC. AND SHALL NOT BE REPRODUCED OR TRANSFERRED TO OTHER DOCUMENTS OR DISCLOSED TO OTHERS OR USED FOR ANY PURPOSE OTHER THAN THAT WHICH IT WAS OBTAINED WITHOUT THE EXPRESSED WRITTEN CONSENT OF SAMTEC, INC.



520 PARK EAST BLVD, NEW ALBANY, IN 47150
 PHONE: 812-944-6733 FAX: 812-948-5047
 e-Mail: info@SAMTEC.com code 55322

MATERIAL: DO NOT SCALE DRAWING SHEET SCALE: 2:1
 INSULATOR: LCP, COLOR: BLACK
 CONTACT: COPPER ALLOY

DESCRIPTION:
 .050 PITCH SOCKET ARRAY ASSEMBLY
 DWG. NO.
 SEAF-XX-XX.X-XX-XX-X-A-XX-K-TR

BY: BRATCHER 05/27/2004 SHEET 1 OF 5

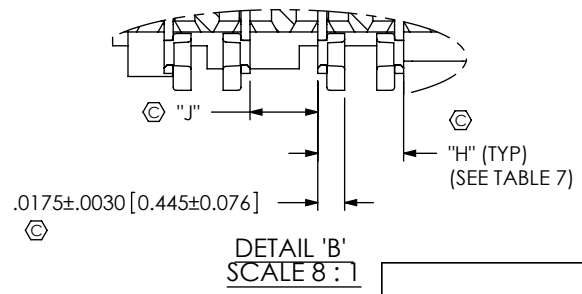
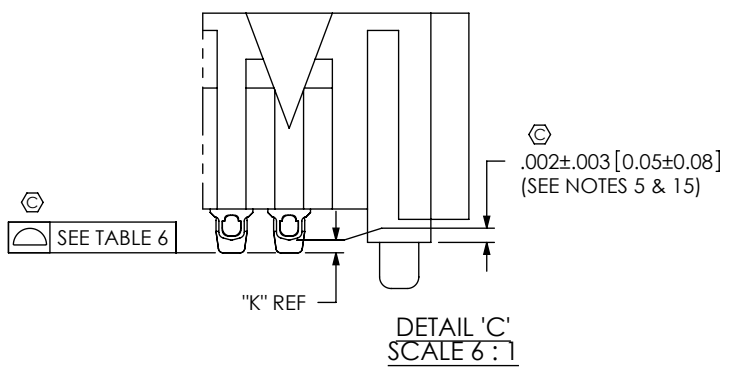
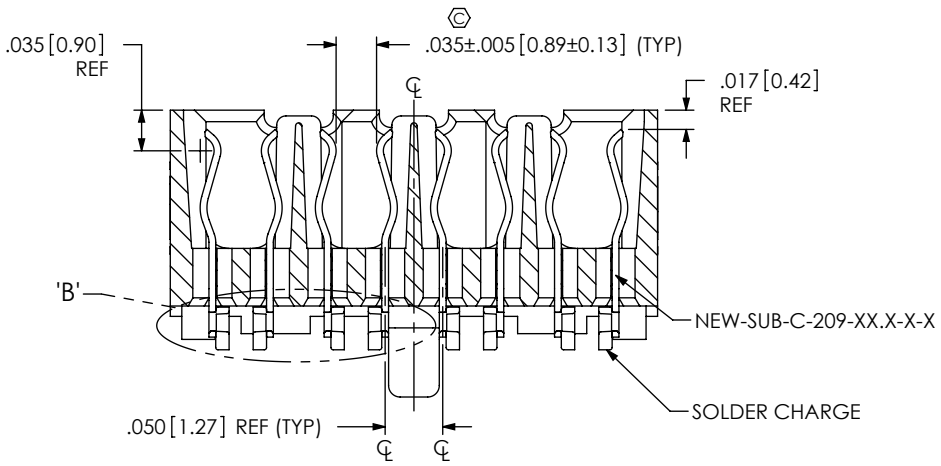

SECTION "A"- "A"
SCALE 6:1

TABLE 6

POSITION	COPLANARITY
-10 TO -30	.006 [0.15]
-40	.009 [0.23]
-50	.009 [0.23]

TABLE 7

LEAD STYLE	"H"	"J"	"K"
-05.0	.0530 - .0590 [1.346] - [1.499]	.0410 - .0470 [1.041] - [1.194]	.011 [0.28]
-06.0	.0530 - .0620 [1.346] - [1.575]	.0380 - .0470 [1.041] - [1.194]	.011 [0.28]
-06.5	.0530 - .0645 [1.346] - [1.638]	.0355 - .0470 [1.041] - [1.194]	.011 [0.28]
*** -07.5	.0530 - .0645 [1.346] - [1.638]	.0355 - .0470 [1.041] - [1.194]	.011 [0.28]

(***= NOT TOOLED)

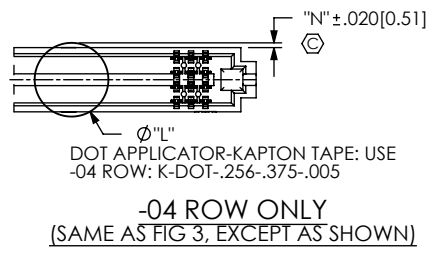
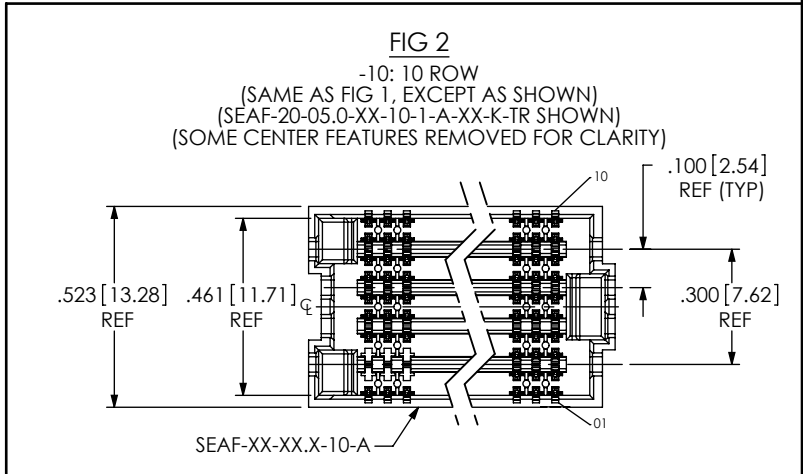
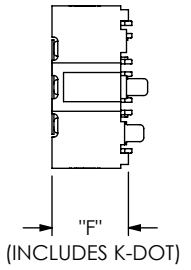
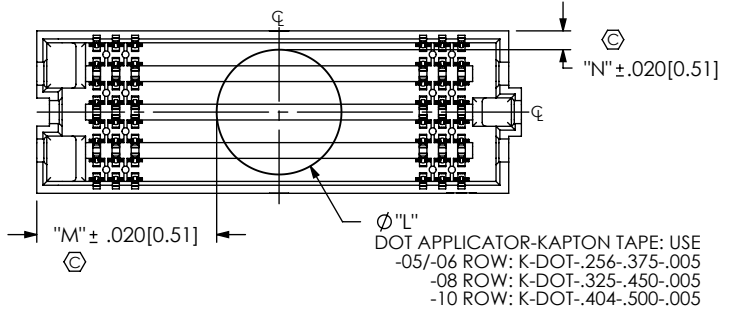

TABLE 8

ROWS	"L"	"M"								"N"
		□ 10 POS	⊠ 15 POS	** 19 POS	20 POS	∇ 25 POS	30 POS	40 POS	50 POS	
-04	.256 [6.50]	.254 [6.44]	.379 [9.62]	.479 [12.16]	.504 [12.79]	.629 [15.97]	.754 [19.14]	1.004 [25.49]	1.254 [31.84]	.017 [.43]
-05, -06	.256 [6.50]	.254 [6.44]	.379 [9.62]	.479 [12.16]	.504 [12.79]	.629 [15.97]	.754 [19.14]	1.004 [25.49]	1.254 [31.84]	.034 [.86]
-08	.325 [8.25]	.219 [5.57]	.344 [8.74]	.444 [11.28]	.469 [11.92]	.594 [15.09]	.719 [18.27]	.969 [24.62]	1.219 [30.97]	.049 [1.24]
-10	.404 [10.25]	.180 [4.57]	.305 [7.74]	.405 [10.28]	.430 [10.92]	.555 [14.09]	.680 [17.27]	.930 [23.62]	1.180 [29.97]	.060 [1.52]

FIG 3
-K: POLYIMIDE PAD
(SEAF-20-05.0-XX-08-1-A-XX-K-TR SHOWN)
(SAME AS FIG. 1, EXCEPT AS SHOWN)
(SOME CENTER FEATURES REMOVED FOR CLARITY)



PROPRIETARY NOTE
THIS DOCUMENT CONTAINS INFORMATION CONFIDENTIAL AND PROPRIETARY TO SAMTEC, INC. AND SHALL NOT BE REPRODUCED OR TRANSFERRED TO OTHER DOCUMENTS OR DISCLOSED TO OTHERS OR USED FOR ANY PURPOSE OTHER THAN THAT WHICH IT WAS OBTAINED WITHOUT THE EXPRESSED WRITTEN CONSENT OF SAMTEC, INC.

DO NOT SCALE DRAWING

SHEET SCALE: 2:1

samtec

520 PARK EAST BLVD. NEW ALBANY, IN 47150
PHONE: 812-944-6733 FAX: 812-948-5047
e-Mail: info@SAMTEC.com code 55322

DESCRIPTION:
.050 PITCH SOCKET ARRAY ASSEMBLY

DWG. NO.
SEAF-XX-XX.X-XX-XX-X-A-XX-K-TR

BY: BRATCHER 05/27/2004 SHEET 2 OF 5

FIG 4
 -06: 6 ROW
 (SAME AS FIG 1, EXCEPT AS SHOWN)
 (SEAF-20-05.0-XX-06-1-A-XX-K-TR SHOWN)
 (SOME CENTER FEATURES REMOVED FOR CLARITY)

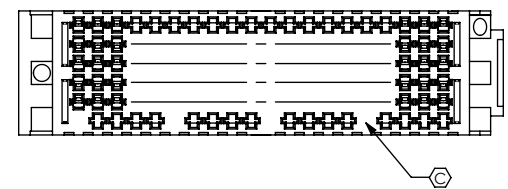
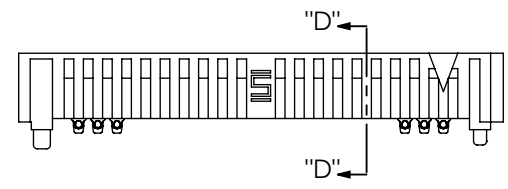
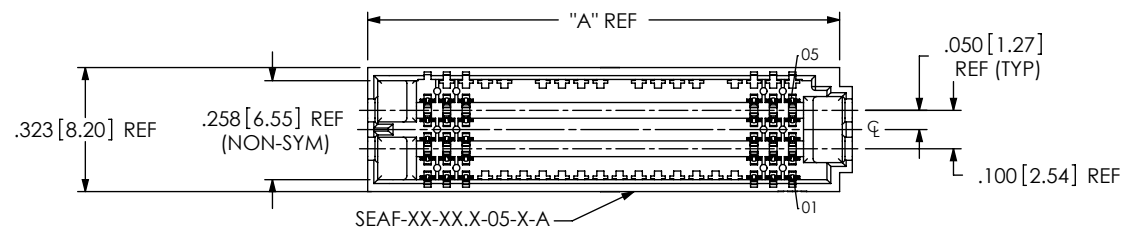
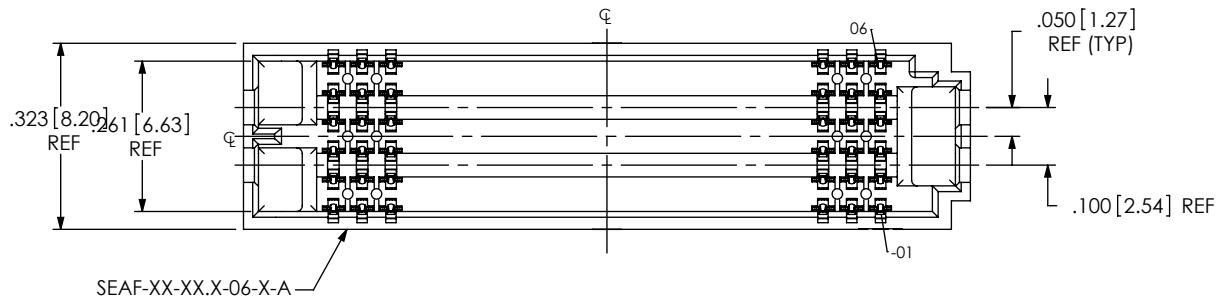
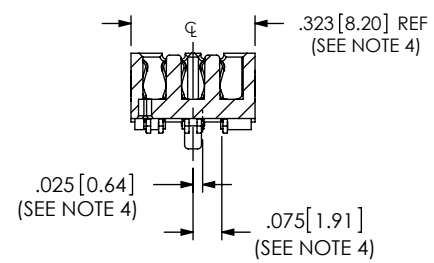

FIG 5
 -05: 5 ROW
 (SAME AS FIG 4, EXCEPT AS SHOWN)
 (SEAF-20-05.0-XX-05-1-A-XX-K-TR SHOWN)
 (SOME CENTER FEATURES REMOVED FOR CLARITY)



SECTION "D"-"D"

PROPRIETARY NOTE
 THIS DOCUMENT CONTAINS INFORMATION
 CONFIDENTIAL AND PROPRIETARY TO
 SAMTEC, INC. AND SHALL NOT BE REPRODUCED
 OR TRANSFERRED TO OTHER DOCUMENTS OR
 DISCLOSED TO OTHERS OR USED FOR ANY
 PURPOSE OTHER THAN THAT WHICH IT WAS
 OBTAINED WITHOUT THE EXPRESSED WRITTEN
 CONSENT OF SAMTEC, INC.

DO NOT SCALE DRAWING
 SHEET SCALE: 1:0.333333



520 PARK EAST BLVD, NEW ALBANY, IN 47150
 PHONE: 812-944-6733 FAX: 812-948-5047
 e-Mail info@SAMTEC.com code 55322

DESCRIPTION:
 .050 PITCH SOCKET ARRAY ASSEMBLY

DWG. NO.
 SEAF-XX-XX.X-XX-XX-X-A-XX-K-TR

BY: BRATCHER 05/27/2004 SHEET 3 OF 5

FIG 7
 06 ROW x 19 POS.
 (SEE NOTE 12)
 (ONLY AVAILABLE -06.5 LEADSTYLE & -06 ROW)
 (SEAF-20-06.5-XX-06-1-XX-K-TR SHOWN)
 (SAME AS FIGS 1 & 4 EXCEPT AS SHOWN)
 (SOME CENTER FEATURES REMOVED FOR CLARITY)

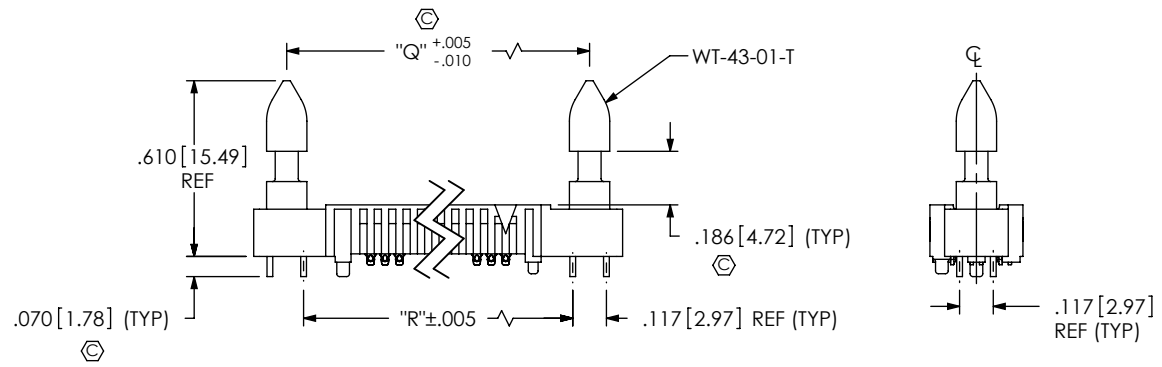
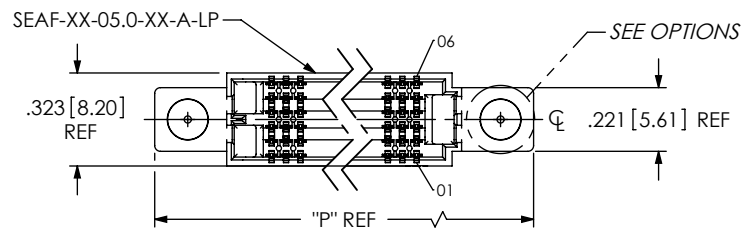
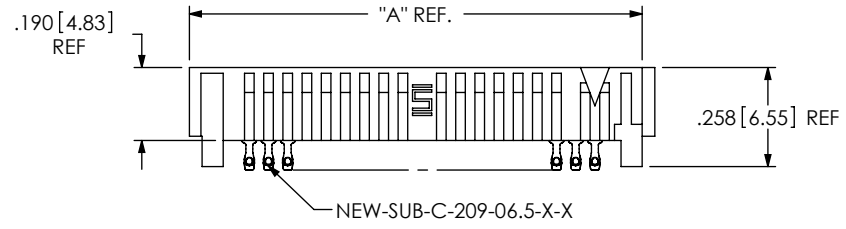
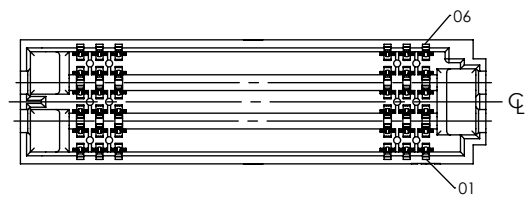

FIG 8
 -LP OPTION
 (SEAF-20-05.0-XX-06-1-A-LP-K-TR SHOWN)
 (SOME CENTER FEATURES REMOVED FOR CLARITY)
 (SAME AS FIG 6 EXCEPT AS SHOWN)
 (-LP OPTION REQUIRED FOR SEAC MATE ONLY)
 (ONLY AVAILABLE WITH -05.0 LEAD STYLE -04, -06, -08 & -10 ROW)

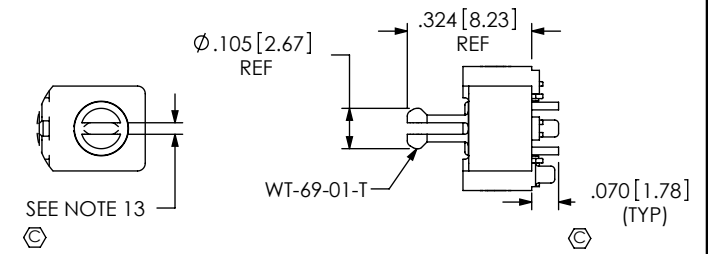

FIG 9
 *****RP OPTION
 (SEAF-20-05.0-XX-06-1-A-RP-K-TR SHOWN)
 (SOME CENTER FEATURES REMOVED FOR CLARITY)
 (SAME AS FIG 7 EXCEPT AS SHOWN)
 (-RP OPTION VALID FOR SEAR MATE ONLY)
 (ONLY AVAILABLE WITH -05.0 LEAD STYLE 6, 8 & 10 ROW)

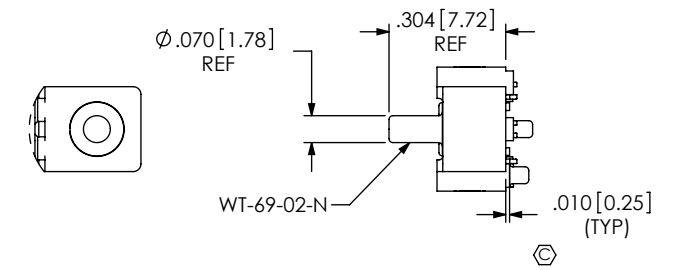



FIG 10
 -PP OPTION
 (SEAF-20-05.0-XX-06-1-A-PP-K-TR SHOWN)
 (SOME CENTER FEATURES REMOVED FOR CLARITY)
 (SAME AS FIG 7 EXCEPT AS SHOWN)
 (-PP OPTION VALID FOR SEAR MATE ONLY)
 (ONLY AVAILABLE WITH -05.0 LEAD STYLE 6, 8 & 10 ROW)

TABLE 9

No OF POS.	"P"	"Q"	"R"
□ -10	1.262 [32.05]	1.033 [26.24]	.9160 [23.266]
⊠ -15	1.512 [38.40]	1.283 [32.59]	1.1660 [29.616]
** -19	1.712 [43.48]	1.483 [37.67]	1.3660 [34.696]
-20	1.762 [44.75]	1.533 [38.94]	1.4160 [35.966]
▤ -25	2.012 [51.10]	1.783 [45.29]	1.6660 [42.316]
-30	2.262 [57.45]	2.033 [51.64]	1.9160 [48.666]
-40	2.762 [70.15]	2.533 [64.34]	2.4160 [61.366]
-50	3.262 [82.85]	3.033 [77.04]	2.9160 [74.066]

<p>PROPRIETARY NOTE THIS DOCUMENT CONTAINS INFORMATION CONFIDENTIAL AND PROPRIETARY TO SAMTEC, INC. AND SHALL NOT BE REPRODUCED OR TRANSFERRED TO OTHER DOCUMENTS OR DISCLOSED TO OTHERS OR USED FOR ANY PURPOSE OTHER THAN THAT WHICH IT WAS OBTAINED WITHOUT THE EXPRESSED WRITTEN CONSENT OF SAMTEC, INC.</p> <p>DO NOT SCALE DRAWING</p> <p>SHEET SCALE: 1:0.333333</p>	
	<p>520 PARK EAST BLVD, NEW ALBANY, IN 47150 PHONE: 812-944-6733 FAX: 812-948-5047 e-Mail: info@SAMTEC.com code 55322</p>
	<p>DESCRIPTION: .050 PITCH SOCKET ARRAY ASSEMBLY</p>
	<p>DWG. NO. SEAF-XX-XX.X-XX-XX-X-A-XX-K-TR</p>
	<p>BY: BRATCHER 05/27/2004 SHEET 4 OF 5</p>

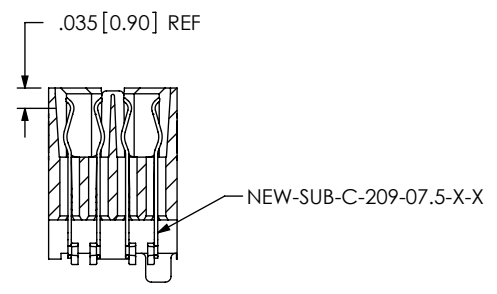
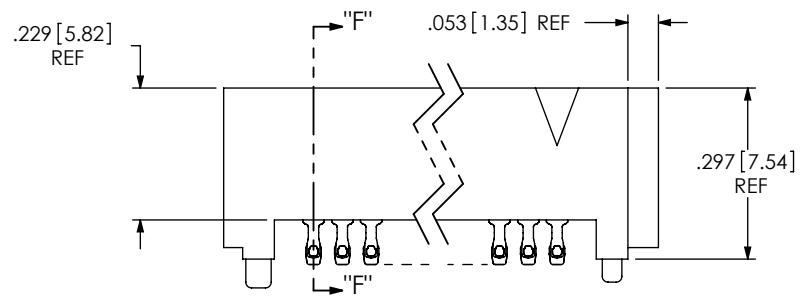
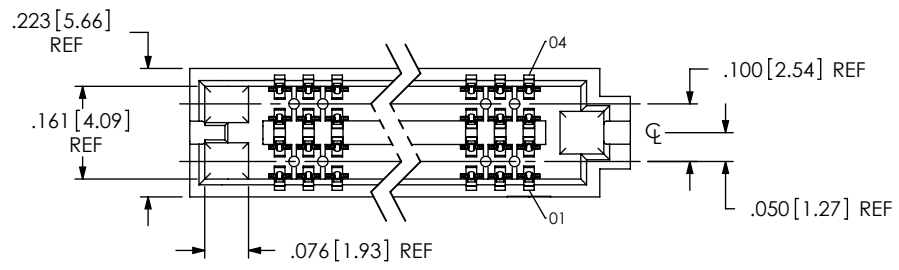



FIG 11
 -04: 4 ROW
 (SEAF-30-07.5-XX-04-1-A-XX-K-TR SHOWN)
 (SOME CENTER FEATURES REMOVED FOR CLARITY)
 (SAME AS FIG 1 EXCEPT AS SHOWN)

<p>PROPRIETARY NOTE</p> <p>THIS DOCUMENT CONTAINS INFORMATION CONFIDENTIAL AND PROPRIETARY TO SAMTEC, INC. AND SHALL NOT BE REPRODUCED OR TRANSFERRED TO OTHER DOCUMENTS OR DISCLOSED TO OTHERS OR USED FOR ANY PURPOSE OTHER THAN THAT WHICH IT WAS OBTAINED WITHOUT THE EXPRESSED WRITTEN CONSENT OF SAMTEC, INC.</p> <p>DO NOT SCALE DRAWING</p> <p>SHEET SCALE: 1:0.333333</p>		
	<p>520 PARK EAST BLVD, NEW ALBANY, IN 47150 PHONE: 812-944-6733 FAX: 812-948-5047 e-Mail info@SAMTEC.com code 55322</p>	
	<p>DESCRIPTION: .050 PITCH SOCKET ARRAY ASSEMBLY</p>	
	<p>DWG. NO. SEAF-XX-XX.X-XX-XX-X-A-XX-K-TR</p>	
<p>BY: BRATCHER 05/27/2004</p>	<p>SHEET 5 OF 5</p>	