

FIREFLY™

MICRO FLYOVER SYSTEM™

FIREFLY™

MICRO FLYOVER SYSTEM™

The FireFly™ Micro Flyover System™ is the first interconnect system that gives a designer the flexibility of using micro footprint optical and copper interconnects interchangeably with the same connector system.

The FireFly™ system enables chip-to-chip, board-to-board, on-board and system-to-system connectivity at data rates up to 28 Gbps. FireFly™ is based on a high-performance interconnect system which allows the use of low-cost copper cables or high-performance active optical engines.

1 PCB CONNECTOR – 3 LEVELS OF CABLE PERFORMANCE

Samtec copper, equalized copper, and optical cable systems provide the flexibility to achieve higher data rates and/or greater distance needs while simplifying board design and enhancing performance.

COPPER

Samtec's twinax ribbon cable can be paired with any of our high-speed/high-density interconnects for performance up to 28 Gbps.

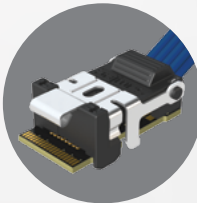

EQUALIZED COPPER

Active and passive equalization options provide an ideal middle-ground solution for cabling applications requiring a 20-30% increase in usable data rate and/or assembly length.



OPTICAL

Samtec's micro optical engine technology paired with our FireFly™ micro high-speed interconnects provide maximum data rates and/or cable assembly lengths.

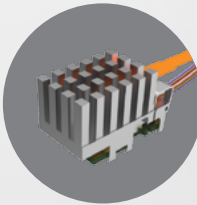

Large choice of end connectors for both optical and copper systems

Integral heat sinks in several default designs, including pin-finned, flat, fiber groove for multi-row configurations, and custom designs

Rugged board-level connector system with positive latching, weld tabs and loading guides for secure connection

FIREFLY™

FEATURES

- Data "flies" over lossy PCB, simplifying board layout and enhancing signal integrity
- Compact size for placement close to IC allowing drive voltages to be lowered resulting in reduced power consumption
- x12 simplex or duplex optical transceiver assembly achieves 14 Gbps per channel (168 Gbps aggregate); 28 Gbps (336 Gbps aggregate), and x4 simplex and duplex systems in development
- Interchangeability of FireFly™ copper and optical using the same connector system
- FireFly™ systems support all data center and HPC protocols, including Ethernet, InfiniBand™ and Fibre Channel
- Thermal operating conditions are optimized through an integral heat sink
- Pigtailed connector, attached heat sink and easy insertion/removal simplifies the assembly process

TECHNOLOGY CENTER

Samtec Optical Group

Engineering team dedicated to the design, development and application support of high-performance micro optical engines, active optical assemblies and high-density ganged passive optical panel solutions. Capable of 14 Gbps, 28 Gbps, and soon 56 Gbps, Samtec's FireFly™ micro on-board optical engines occupy the smallest overall footprint, consume the least amount of power and enable fast, easy and low-cost fiber termination.



Low-cost, high-performance (to 28 Gbps) twinax cable system ideal for short distances and test applications (Compliance cables available, see back cover)

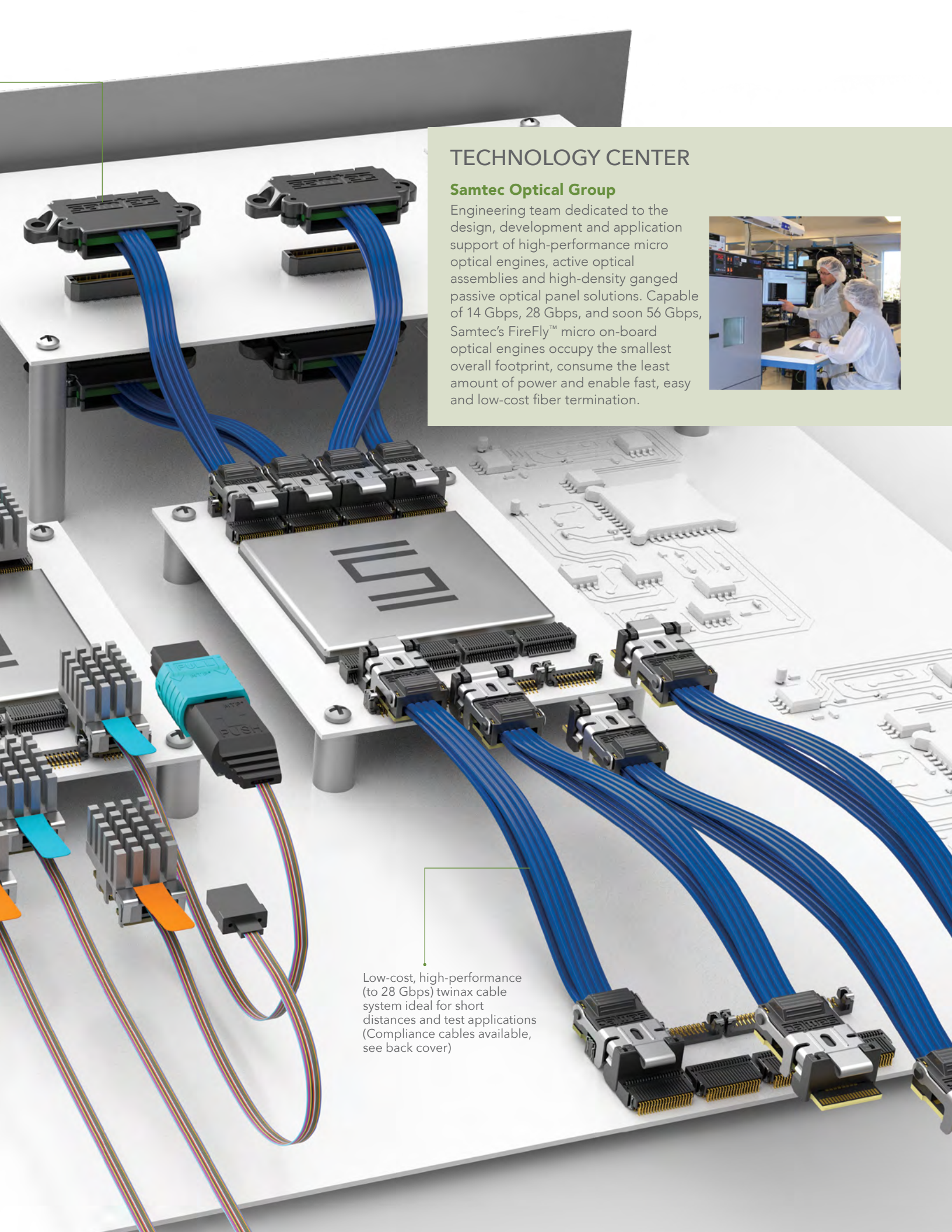

ACTIVE OPTICAL CABLE

Designed for flexibility, FireFly™ optical is interchangeable with copper using the same connector system. FireFly™ optical features:

- x12 simplex or duplex transceiver system
- x4 simplex and duplex systems in development
- 14 Gbps or 28 Gbps (in development) per channel
- Proven 850 nm VCSEL array
- OM3 multi-mode fiber
- Integrated AC coupling capacitors
- Integral heat sink in several default designs, including pin-finned (14 Gbps only), flat, fiber groove for multi-row configurations, and customs
- 10° angled fiber exit from the housing to minimize keep-out zone on the board and reduce total power consumption
- Close proximity to data source simplifying board layout and enhancing signal integrity
- Extended temperature system (ETUO Series)
 - Range from -40 °C to +85 °C to handle harsh environments
 - High-speed performance to 10.3125 Gbps per channel
- 56 Gbps in development

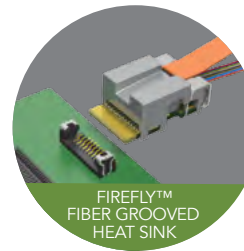

Series	Width	Data Rate	Overall Length	0	Heat Sink	1	Fiber Type	End 2 Options
= ECUO Optical	-U12 = x12 Tx to Rx Simplex Full Active Optical	-10 = 10 Gbps (ETUO only)	-"XXX" = Overall Length in Centimeters (011 cm - 999 cm) (For ECUO minimum length will depend on fiber type and End 2 option specified)		-1 = Flat		-1 = OM3 Low Bend Radius Ribbon	Leave blank for Full Active Optical (-U12). -Y12 requires 24 fibers.
= ETUO Extended Temperature	-T12 = x12 Tx Simplex Half Active Optical -R12 = x12 Rx Simplex Half Active Optical -Y12 = x12 Duplex Half Active Optical (Y Configuration) -B04 = x4 Duplex (in development; ECUO only)	-14 = 14 Gbps (168 Gbps aggregate; ECUO only) -28 = 28 Gbps (in development; ECUO only)			-2 = Pin-Fin (-10 & -14 Data Rate only) -3 = Flat with 3-ribbon pass-through -4 = PCIe® Pin-Fin (-10 & -14 Data Rate only)		-2 = OM3 Low Bend Radius Loose Tube	12 Fibers -01 = MTP®, male -02 = MTP®, female -03 = MPO, male -04 = MPO, female -05 = MT male -06 = MT female
								24 Fibers -21 = MTP®, male -22 = MTP®, female -23 = MPO, male -24 = MPO, female -25 = MT male -26 = MT female

DIMENSIONAL INFORMATION:

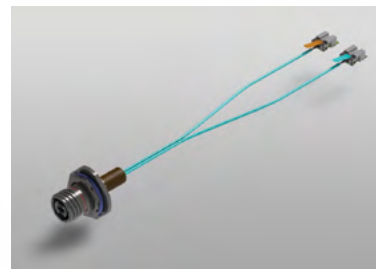
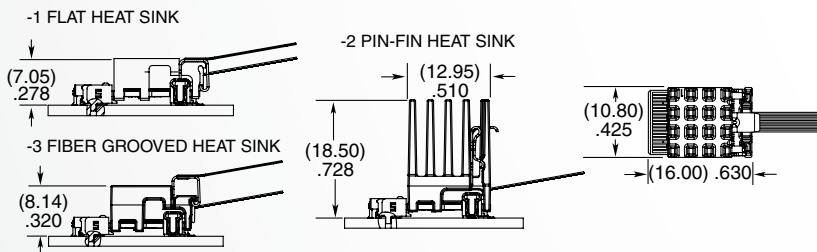

Samtec and Amphenol® Aerospace partner to provide embedded optics for rugged environments. Contact Samtec for more information.

CONNECTOR SYSTEM

Mates with both FireFly™ optical (ECUO Series) and copper (ECUE Series) cable assemblies.

The optical and copper cables mount onto a board using a low insertion force two-piece connector system: a micro high-speed edge card and a positive latch connector.

- This connector system can tolerate a 30 N down force
- The high-speed edge card connector provides data and supports speeds up to 28 Gbps
- The positive latch connector provides mechanical support as well as optional power and low-speed communications
- The positive latch mechanism is used to secure the cable assembly to the board
- Weld tabs significantly increase shear resistance of the connector to the PCB
- Part Numbers: UEC5-019-1-H-D-RA-X-A and UCC8-010-1-H-S-X-A

COPPER CABLE

A low-cost FireFly™ copper solution is available based on Samtec's 100 Ω 34 AWG and 36 AWG twinax ribbon cable. This cable is extensively used with existing high-speed cable assemblies. FireFly™ copper features:

- A large variety of end two connector termination options including high-speed edge card, high-density arrays, and high-speed connectors
- Seamless integration of new and existing designs
- Performance up to 28 Gbps
- Passive and active equalized assemblies available
- Capability to enable test and verification of connectors during manufacturing; allowing early diagnosis of data connectivity issues (Compliance cables available, see back cover)
- Positive latching feature for ease of engagement/disengagement
- Pin compatible with FireFly™ optical



Standard Copper (ECUE Series)

- lowest cost solution
- 100 Ω, 34 AWG or 36 AWG twinax ribbon cable
- x12 bidirectional



Passive Equalized Copper (ECUE-E Series)

- provides a performance boost or enables longer cable lengths
- 100 Ω, 34 AWG or 36 AWG twinax ribbon cable
- x8 and x12 bidirectional

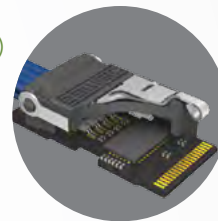

Active Equalized Copper (ECUE-E Series)

- provides greater performance boost or enables even longer cable lengths
- 100 Ω, 34 AWG twinax ribbon cable
- x4 bidirectional
- low power consumption

ECUE	No. of Pairs	Overall Length	Cable Type	End 2 Options	Wiring Option	Profile	Option
	-08 = T2 cable only -12 = T1 cable only	-"XXX" = Overall Length in Centimeters (007 cm - 999 cm)	-T1 = 36 AWG twinax ribbon (-12 pairs only) -T2 = 34 AWG twinax ribbon (-08 pairs only)	-FF = ECUE Also Available = Q Rate®, Edge Rate®, Edge Card, SEARAY™, Q Series®	-01 = Pin A1 to Pin A19 -02 = Pin A1 to Pin B1 (-02 required for pinout compatibility with ECUO Series optical assemblies) -B4 = Pin A1 to Pin B19 (-08 pair only)	1 = Low Profile	Leave blank for standard FireFly™ -D1 = Decoupling Capacitors (only available with -B4 and -02 options)

ECUE-E	No. of Pairs	Overall Length	Shielded Cable Type	Wiring Option
	-08 = T2 passive cable -12 = T1 passive cable -B4 = T2 active cable	-"XXX" = Overall Length in Centimeters (010 cm - 999 cm)	-T1 = 36 AWG twinax (12 pairs only) (Passive Equalized) -T2 = 34 AWG twinax (8 pairs only)	-P2 = Pin A1 to Pin B1 (Passive Equalized only) -P4 = Pin A1 to Pin B19 (Passive Equalized only) -A4 = Pin A1 to Pin B19 (Active Equalized only)

DIMENSIONAL INFORMATION:

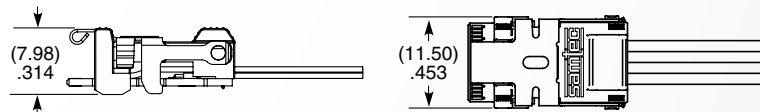

High-speed edge card connector (UEC5 Series)

Loading guide

Rugged positive latching feature

Weld tabs

Power and low-speed signal contact receptacle (UCC8 Series)

DIMENSIONAL INFORMATION:

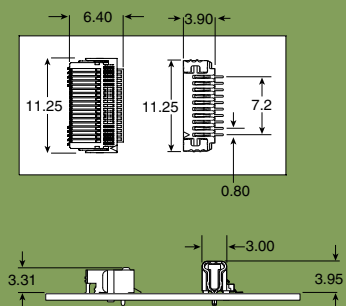

FLYOVER SOLUTIONS



HIGHEST DENSITY

Micro footprint flyovers free up space on the main board for additional components and/or connectors. The highest 28 Gbps bandwidth available with x12 bidirectional channels in 0.63 square inches.

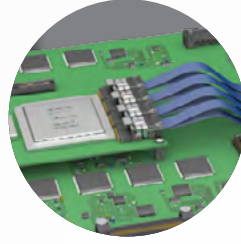

EASE OF ROUTING

The two-piece board level interconnect isolates the signal and power to help ease trace routing compared to array systems. Flyovers simplify PCB design and allow greater component density under the flyover.

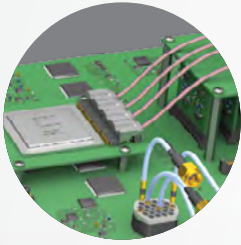

EASE OF ASSEMBLY

The rugged two-piece socket system, with weld tabs, latch locking and loading guides, provides simplified mating and unmating compared to a compression system using mechanical screw downs and hardware.



SIGNAL INTEGRITY

By taking data connections "off board" with flyover cables, the signal integrity design is made easier and electrical performance improved. Allowing data to "fly over" lossy board materials and other signal degrading components negates the need for the layout complexities that are required to design for high-speed signaling.

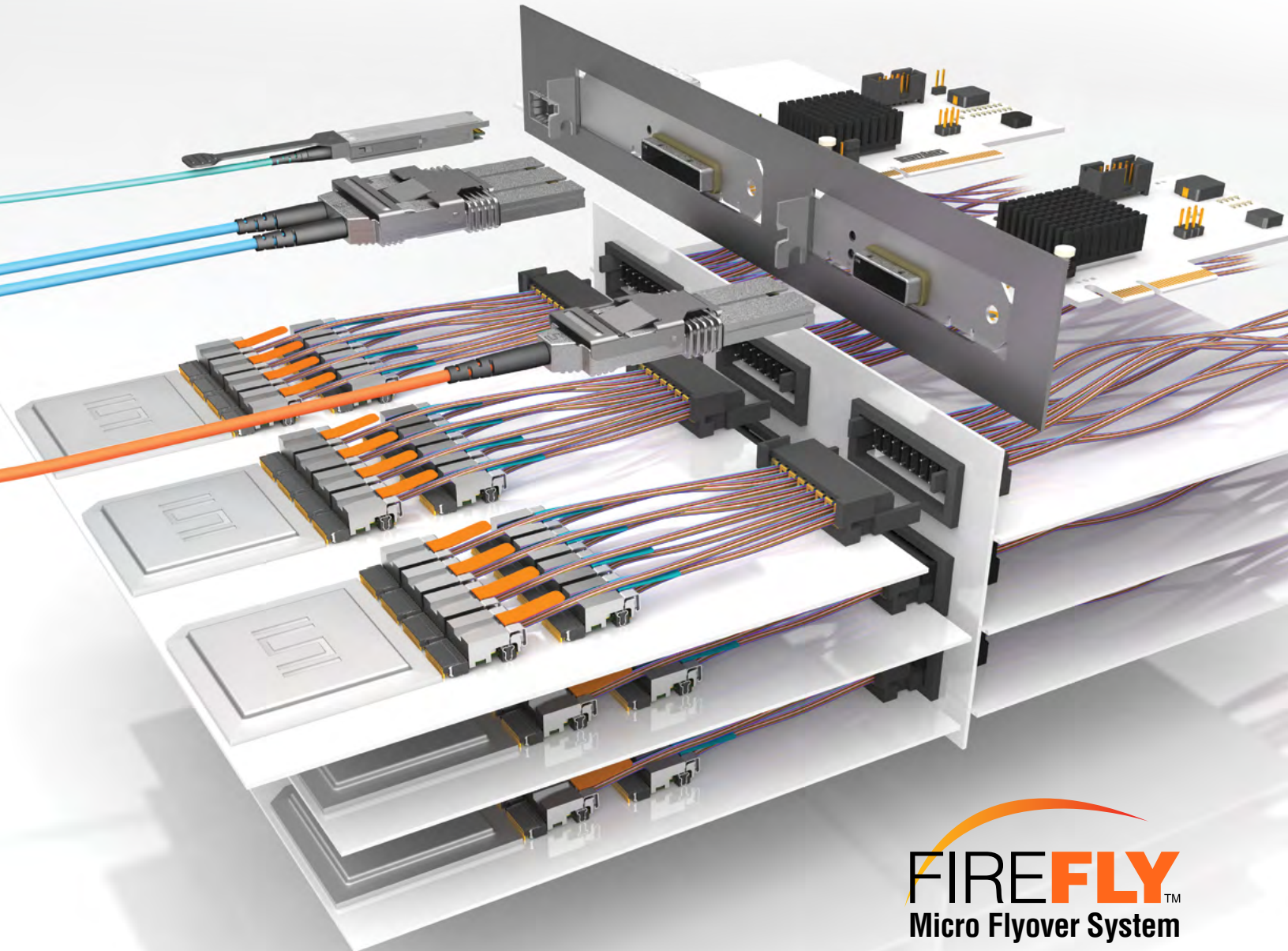

DEVELOPMENT SOLUTIONS

THE EXPANDING FMC ECOSYSTEM

As FMC leverages open platforms and standards, developers today are working to further the adaptation of programmable device technologies in the marketplace. Many of these developers are working closely with Samtec to support a variety of applications, including:

TechwaY TigerFMC

VITA 57.1 compliant mezzanine card integrates 10 full duplex 10 Gbps optical links for 200 Gbps aggregate bandwidth.

- (1) VITA 57.1 FMC (HPC) 400 I/O Male Connector (SEARAY™ ASP-134488-01)
- (2) High-Speed Edge Card Connector Sets (FireFly™ Connector System UEC5 / UCC8 Series)
- (1) x12 Duplex (12 Tx / 12 Rx) Optical I/O via 24F MTP® Connector (FireFly™ Optical Micro Flyover System™ ECUO Series)

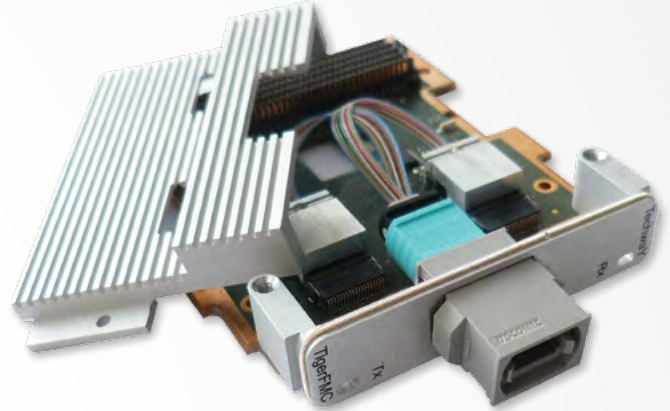

ADVANCED & EMBEDDED SYSTEMS

Samtec offers co-development and co-marketing opportunities for a variety of systems, working closely with semiconductor manufacturers and companies developing FPGA or ASIC-based systems, to address their interconnectivity needs.

This type of collaboration has led to the incorporation of some of Samtec's latest, most innovative products and technologies into silicon development solutions. For example, the new ultra micro x12 FireFly™ optical system with 14 Gbps per channel over optical fiber, can be launched as a mid-board optics flyover solution, and as a fast-path I/O via MTP® to go outside of the box.

HiTech Global HTG-712 VIRTEX®-7 HIGH-END NETWORKING CARD

Xilinx® Virtex®-7 powered card is ideal for high-end networking applications requiring 336 Gbps aggregate data rates, high-performance computing, high-end image processing, PCI Express® Gen 2 & 3 development and FPGA development.

- (1) VITA 57.1 FMC (HPC) 400 I/O (SEARAY™ ASP-134486-01)
- (2) High-Speed Edge Card Connector Sets (FireFly™ Connector System UEC5 / UCC8 Series)
- (1) x12 Simplex (Tx) Optical I/O and (1) x12 Simplex (Rx) Optical I/O (FireFly™ Optical Micro Flyover System™ ECUO Series)

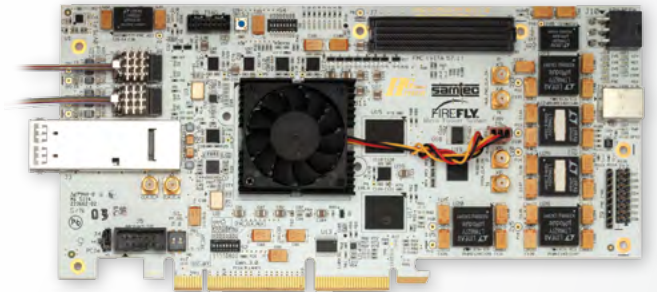

OPTICS ROADMAP

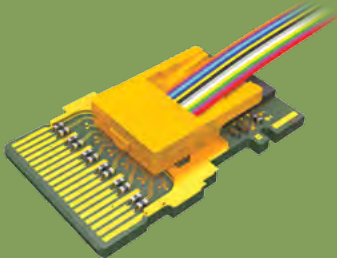

56 Gbps Optical Engine Development (PAM4)

Solutions in research and development for next generation transmission lines

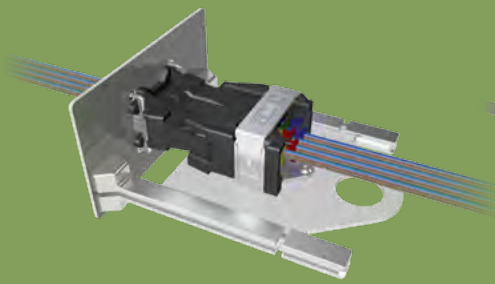

Ganged Optics

Greatest linear density for passive optical backplanes in the industry

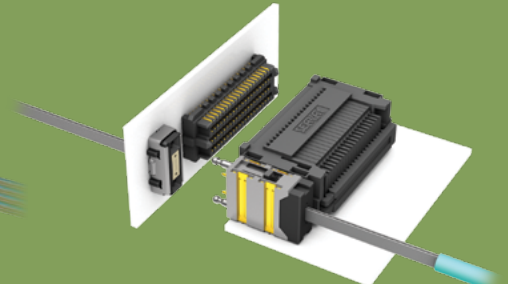

SEARAY™ Optical

Right-angle array with integrated optics to support VITA 74 and 28 Gbps performance

FIREFLY™ EVALUATION KIT

Samtec's FireFly™ Evaluation Kit is rated up to 28 Gbps and allows the designer real-time evaluation of an actively running copper or electrical FireFly™ system in their lab, with their inputs. The evaluation board connects the FireFly™ connector system (UEC5/UCC8 Series) to a 24-position Bulls Eye® system and brings the low-speed signals and power rails to various standard connectors. The Bulls Eye® system allows for connecting all 12 FireFly™ channels to various laboratory test equipment. A second Bulls Eye® connector landing pad enables de-embedding of the Bulls Eye® interconnect and PCB effects on the high speed signals.

Evaluation Kit Part Number: FIK-FIREFLY-XX

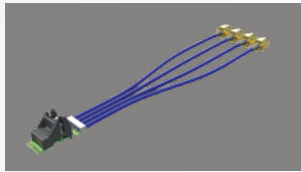

Samtec's FireFly™ Compliance Cables: HDR-179381-XX (Six HDR cables will be needed to test all connections.)

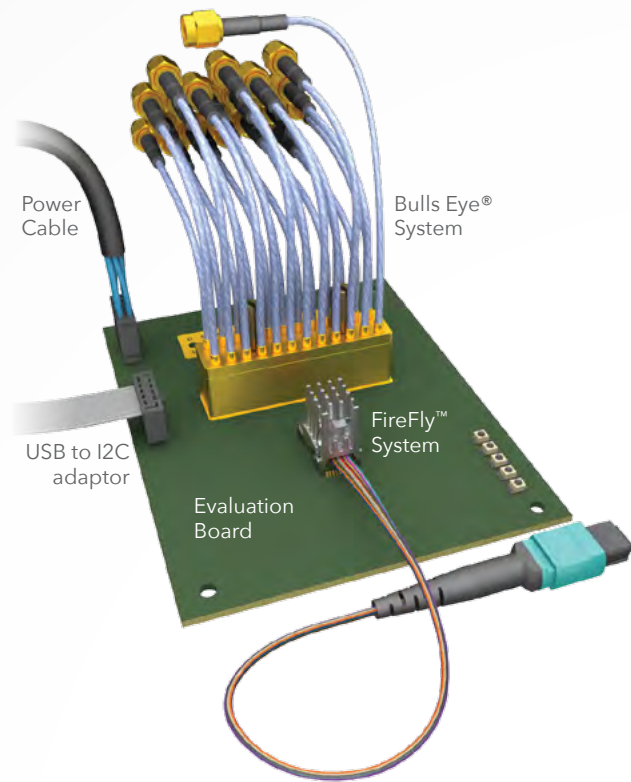

FIREFLY™ OPTICAL SPECIFICATIONS

Parameters	Units	Min.	Typical	Max.	Notes
Operating/Mechanical Specifications					
Power Supply Voltage	V	3.15	3.3	3.45	
Power Consumption	W		0.7	1.5	Transmitter for the x12 FireFly™
			0.8	2.15	Receiver for the x12 FireFly™
			1.1	2	x4 Duplex
Heat Sink Temperature	°C	0		70	
ECUO Series Pigtail Length	m			9.9	FireFly™-to-optical connector
ECUO Series AOC Length	m			9.9	
ECUE Series Copper Cable Length	m			1.5	
Optical Cable Bend Radius	mm	7.5			
Electrical Specifications					
Data Rate per Channel	Gbps	1		14.1	
Differential Input Amplitude	mV	250		1600	x12 FireFly™
Differential Output Amplitude	mV	250		760	x12 FireFly™
Optical Specifications					
Center Wavelength	nm	840		860	
Transmitter RMS Spectral Width	nm			0.65	
Transmitter RIN	dB/Hz			-128	
Average Optical Power	dBm	-7.6		2.4	
Optical Modulation Amplitude	dBm	-5.6		3	
Average Power at Receiver Input (each lane)	dBm	-9.5		2.4	
Stressed Receiver Sensitivity	dBm			-5.4	Following IEEE 802.3ae requirement

All connectorized cables use OM3 fiber. Links of up to 100 m on OM3 are supported assuming that there is a maximum of 1.5 dB loss in the link. MTP® is a registered trademark of US Conec Ltd. PCIe® is a registered trademark of PCI-SIG®.

For more information on FireFly™ optical or copper systems visit www.samtec.com/firefly or contact FireFly@samtec.com



UNITED STATES • NORTHERN CALIFORNIA • SOUTHERN CALIFORNIA • SOUTH AMERICA • UNITED KINGDOM • GERMANY • FRANCE • ITALY • NORDIC/BALTIC
BENELUX • ISRAEL • INDIA • AUSTRALIA / NEW ZEALAND • SINGAPORE • JAPAN • SHANGHAI • SHENZHEN • TAIWAN • HONG KONG • KOREA