

FEATURES

- Available in the Texas Instruments NanoStar™ and NanoFree™ Packages
- Control Inputs V_{IH}/V_{IL} Levels Are Referenced to V_{CCA} Voltage
- Fully Configurable Dual-Rail Design Allows Each Port to Operate Over the Full 1.2-V to 3.6-V Power-Supply Range
- I/Os Are 4.6-V Tolerant
- I_{off} Supports Partial-Power-Down Mode Operation
- Bus Hold on Data Inputs Eliminates the Need for External Pullup/Pulldown Resistors
- Typical Max Data Rates
 - 380 Mbps (1.8-V to 3.3-V Translation)
 - 200 Mbps (<1.8-V to 3.3-V Translation)
 - 200 Mbps (Translate to 2.5 V or 1.8 V)
 - 150 Mbps (Translate to 1.5 V)
 - 100 Mbps (Translate to 1.2 V)
- Latch-Up Performance Exceeds 100 mA Per JESD 78, Class II
- ESD Protection Exceeds JESD 22
 - 2000-V Human-Body Model (A114-A)
 - 200-V Machine Model (A115-A)
 - 1000-V Charged-Device Model (C101)

DBV OR DCK PACKAGE
(TOP VIEW)

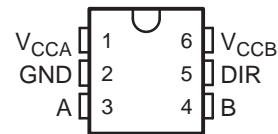

YEP OR YZP PACKAGE
(BOTTOM VIEW)

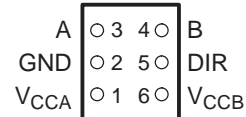

DESCRIPTION/ORDERING INFORMATION

This single-bit noninverting bus transceiver uses two separate configurable power-supply rails. The A port is designed to track V_{CCA} . V_{CCA} accepts any supply voltage from 1.2 V to 3.6 V. The B port is designed to track V_{CCB} . V_{CCB} accepts any supply voltage from 1.2 V to 3.6 V. This allows for universal low-voltage bidirectional translation between any of the 1.2-V, 1.5-V, 1.8-V, 2.5-V, and 3.3-V voltage nodes.

The SN74AVCH1T45 is designed for asynchronous communication between data buses. The device transmits data from the A bus to the B bus or from the B bus to the A bus, depending on the logic level at the direction-control (DIR) input.

The SN74AVCH1T45 is designed so that the DIR input is powered by V_{CCA} .

ORDERING INFORMATION

T_A	PACKAGE ⁽¹⁾		ORDERABLE PART NUMBER	TOP-SIDE MARKING ⁽²⁾
–40°C to 85°C	NanoFree™ – WCSP (DSBGA) 0.23-mm Large Bump – YZP (Pb-free)	Tape and reel	SN74AVCH1T45YZPR	___TF_
	SOT (SOT-23) – DBV	Tape and reel	SN74AVCH1T45DBVR	ET1_
	SOT (SC-70) – DCK	Tape and reel	SN74AVCH1T45DCKR	TF_

(1) Package drawings, thermal data, and symbolization are available at www.ti.com/packaging.

(2) DBV/DCK: The actual top-side marking has one additional character that designates the assembly/test site.

YZP: The actual top-side marking has three preceding characters to denote year, month, and sequence code, and one following character to designate the assembly/test site. Pin 1 identifier indicates solder-bump composition (1 = SnPb, • = Pb-free).



Please be aware that an important notice concerning availability, standard warranty, and use in critical applications of Texas Instruments semiconductor products and disclaimers thereto appears at the end of this data sheet.

NanoStar, NanoFree are trademarks of Texas Instruments.

SN74AVCH1T45
SINGLE-BIT DUAL-SUPPLY BUS TRANSCEIVER
WITH CONFIGURABLE VOLTAGE TRANSLATION AND 3-STATE OUTPUTS

SCES598D–JULY 2004–REVISED JANUARY 2008

DESCRIPTION/ORDERING INFORMATION (CONTINUED)

This device is fully specified for partial-power-down applications using I_{off} . The I_{off} circuitry disables the outputs, preventing damaging current backflow through the device when it is powered down.

The V_{CC} isolation feature ensures that if either V_{CC} input is at GND, then both outputs are in the high-impedance state. The bus-hold circuitry on the powered-up side always stays active.

Active bus-hold circuitry holds unused or undriven inputs at a valid logic state. Use of pullup or pulldown resistors with the bus-hold circuitry is not recommended.

NanoFree™ package technology is a major breakthrough in IC packaging concepts, using the die as the package.

FUNCTION TABLE

INPUT DIR	OPERATION
L	B data to A bus
H	A data to B bus

LOGIC DIAGRAM (POSITIVE LOGIC)

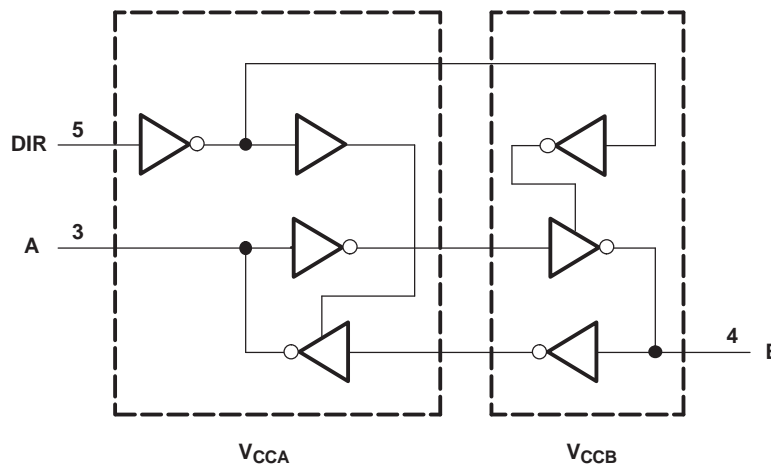

Absolute Maximum Ratings⁽¹⁾

over operating free-air temperature range (unless otherwise noted)

			MIN	MAX	UNIT
V_{CCA} V_{CCB}	Supply voltage range		–0.5	4.6	V
V_I	Input voltage range ⁽²⁾	I/O ports (A port)	–0.5	4.6	V
		I/O ports (B port)	–0.5	4.6	
		Control inputs	–0.5	4.6	
V_O	Voltage range applied to any output in the high-impedance or power-off state ⁽²⁾	A port	–0.5	4.6	V
		B port	–0.5	4.6	
V_O	Voltage range applied to any output in the high or low state ⁽²⁾⁽³⁾	A port	–0.5	$V_{CCA} + 0.5$	V
		B port	–0.5	$V_{CCB} + 0.5$	
I_{IK}	Input clamp current	$V_I < 0$		–50	mA
I_{OK}	Output clamp current	$V_O < 0$		–50	mA
I_O	Continuous output current			±50	mA
	Continuous current through V_{CCA} , V_{CCB} , or GND			±100	mA
θ_{JA}	Package thermal impedance ⁽⁴⁾	DBV package		165	°C/W
		DCK package		259	
		YZP package		123	
T_{stg}	Storage temperature range		–65	150	°C

(1) Stresses beyond those listed under "absolute maximum ratings" may cause permanent damage to the device. These are stress ratings only, and functional operation of the device at these or any other conditions beyond those indicated under "recommended operating conditions" is not implied. Exposure to absolute-maximum-rated conditions for extended periods may affect device reliability.

(2) The input voltage and output negative-voltage ratings may be exceeded if the input and output current ratings are observed.

(3) The output positive-voltage rating may be exceeded up to 4.6 V maximum if the output current rating is observed.

(4) The package thermal impedance is calculated in accordance with JESD 51-7.

SN74AVCH1T45
SINGLE-BIT DUAL-SUPPLY BUS TRANSCEIVER
WITH CONFIGURABLE VOLTAGE TRANSLATION AND 3-STATE OUTPUTS

SCES598D–JULY 2004–REVISED JANUARY 2008

Recommended Operating Conditions⁽¹⁾⁽²⁾⁽³⁾⁽⁴⁾⁽⁵⁾

		V_{CCI}	V_{CCO}	MIN	MAX	UNIT
V_{CCA}	Supply voltage			1.2	3.6	V
V_{CCB}	Supply voltage			1.2	3.6	V
V_{IH}	High-level input voltage	Data inputs ⁽⁴⁾	1.2 V to 1.95 V	$V_{CCI} \times 0.65$		V
			1.95 V to 2.7 V	1.6		
			2.7 V to 3.6 V	2		
V_{IL}	Low-level input voltage	Data inputs ⁽⁴⁾	1.2 V to 1.95 V	$V_{CCI} \times 0.35$		V
			1.95 V to 2.7 V	0.7		
			2.7 V to 3.6 V	0.8		
V_{IH}	High-level input voltage	DIR (referenced to V_{CCA}) ⁽⁵⁾	1.2 V to 1.95 V	$V_{CCA} \times 0.65$		V
			1.95 V to 2.7 V	1.6		
			2.7 V to 3.6 V	2		
V_{IL}	Low-level input voltage	DIR (referenced to V_{CCA}) ⁽⁵⁾	1.2 V to 1.95 V	$V_{CCA} \times 0.35$		V
			1.95 V to 2.7 V	0.7		
			2.7 V to 3.6 V	0.8		
V_I	Input voltage			0	3.6	V
V_O	Output voltage	Active state		0	V_{CCO}	V
		3-state		0	3.6	
I_{OH}	High-level output current		1.2 V	–3		mA
			1.4 V to 1.6 V	–6		
			1.65 V to 1.95 V	–8		
			2.3 V to 2.7 V	–9		
			3 V to 3.6 V	–12		
I_{OL}	Low-level output current		1.2 V	3		mA
			1.4 V to 1.6 V	6		
			1.65 V to 1.95 V	8		
			2.3 V to 2.7 V	9		
			3 V to 3.6 V	12		
$\Delta t/\Delta v$	Input transition rise or fall rate				5	ns/V
T_A	Operating free-air temperature			–40	85	°C

- (1) V_{CCI} is the V_{CC} associated with the input port.
- (2) V_{CCO} is the V_{CC} associated with the output port.
- (3) All unused data inputs of the device must be held at V_{CCI} or GND to ensure proper device operation. Refer to the TI application report, *Implications of Slow or Floating CMOS Inputs*, literature number SCBA004.
- (4) For V_{CCI} values not specified in the data sheet, V_{IH} min = $V_{CCI} \times 0.7$ V, V_{IL} max = $V_{CCI} \times 0.3$ V.
- (5) For V_{CCI} values not specified in the data sheet, V_{IH} min = $V_{CCA} \times 0.7$ V, V_{IL} max = $V_{CCA} \times 0.3$ V.

Electrical Characteristics⁽¹⁾⁽²⁾

over recommended operating free-air temperature range (unless otherwise noted)

PARAMETER	TEST CONDITIONS		V _{CCA}	V _{CCB}	T _A = 25°C			–40°C to 85°C		UNIT
					MIN	TYP	MAX	MIN	MAX	
V _{OH}	I _{OH} = –100 μA I _{OH} = –3 mA I _{OH} = –6 mA I _{OH} = –8 mA I _{OH} = –9 mA I _{OH} = –12 mA	V _I = V _{IH}	1.2 V to 3.6 V	1.2 V to 3.6 V				V _{CCO} – 0.2 V		V
			1.2 V	1.2 V	0.95					
			1.4 V	1.4 V				1.05		
			1.65 V	1.65 V				1.2		
			2.3 V	2.3 V				1.75		
			3 V	3 V				2.3		
V _{OL}	I _{OL} = 100 μA I _{OL} = 3 mA I _{OL} = 6 mA I _{OL} = 8 mA I _{OL} = 9 mA I _{OL} = 12 mA	V _I = V _{IL}	1.2 V to 3.6 V	1.2 V to 3.6 V				0.2		V
			1.2 V	1.2 V	0.15					
			1.4 V	1.4 V				0.35		
			1.65 V	1.65 V				0.45		
			2.3 V	2.3 V				0.55		
			3 V	3 V				0.7		
I _I	DIR	V _I = V _{CCA} or GND	1.2 V to 3.6 V	1.2 V to 3.6 V	±0.025	±0.25			±1	μA
I _{BHL} ⁽³⁾	V _I = 0.42 V		1.2 V	1.2 V	25					μA
	V _I = 0.49 V		1.4 V	1.4 V				15		
	V _I = 0.58 V		1.65 V	1.65 V				25		
	V _I = 0.7 V		2.3 V	2.3 V				45		
	V _I = 0.8 V		3.3 V	3.3 V				100		
I _{BHH} ⁽⁴⁾	V _I = 0.78 V		1.2 V	1.2 V	–25					μA
	V _I = 0.91 V		1.4 V	1.4 V				–15		
	V _I = 1.07 V		1.65 V	1.65 V				–25		
	V _I = 1.6 V		2.3 V	2.3 V				–45		
	V _I = 2 V		3.3 V	3.3 V				–100		
I _{BHLO} ⁽⁵⁾	V _I = 0 to V _{CC}		1.2 V	1.2 V	50					μA
			1.6 V	1.6 V				125		
			1.95 V	1.95 V				200		
			2.7 V	2.7 V				300		
			3.6 V	3.6 V				500		
I _{BHHO} ⁽⁶⁾	V _I = 0 to V _{CC}		1.2 V	1.2 V	–50					μA
			1.6 V	1.6 V				–125		
			1.95 V	1.95 V				–200		
			2.7 V	2.7 V				–300		
			3.6 V	3.6 V				–500		

(1) V_{CCO} is the V_{CC} associated with the output port.

(2) V_{CCI} is the V_{CC} associated with the input port.

(3) The bus-hold circuit can sink at least the minimum low sustaining current at V_{IL} max. I_{BHL} should be measured after lowering V_{IN} to GND and then raising it to V_{IL} max.

(4) The bus-hold circuit can source at least the minimum high sustaining current at V_{IH} min. I_{BHH} should be measured after raising V_{IN} to V_{CC} and then lowering it to V_{IH} min.

(5) An external driver must source at least I_{BHLO} to switch this node from low to high.

(6) An external driver must sink at least I_{BHHO} to switch this node from high to low.

SN74AVCH1T45
SINGLE-BIT DUAL-SUPPLY BUS TRANSCEIVER
WITH CONFIGURABLE VOLTAGE TRANSLATION AND 3-STATE OUTPUTS

SCES598D–JULY 2004–REVISED JANUARY 2008

Electrical Characteristics⁽¹⁾⁽²⁾ (Continued)

over recommended operating free-air temperature range (unless otherwise noted)

PARAMETER		TEST CONDITIONS	V _{CCA}	V _{CCB}	T _A = 25°C			–40°C to 85°C		UNIT
					MIN	TYP	MAX	MIN	MAX	
I _{off}	A port	V _I or V _O = 0 to 3.6 V	0 V	0 to 3.6 V		±0.1	±1	±5		μA
	B port		0 to 3.6 V	0 V		±0.1	±1	±5		
I _{OZ}	B port	V _O = V _{CCO} or GND, V _I = V _{CCI} or GND	0 V	3.6 V		±0.5	±2.5	5		μA
	A port		3.6 V	0 V		±0.5	±2.5	5		
I _{CCA}		V _I = V _{CCI} or GND, I _O = 0	1.2 V to 3.6 V	1.2 V to 3.6 V				10		μA
			0 V	3.6 V				–2		
			3.6 V	0 V				10		
I _{CCB}		V _I = V _{CCI} or GND, I _O = 0	1.2 V to 3.6 V	1.2 V to 3.6 V				10		μA
			0 V	3.6 V				10		
			3.6 V	0 V				–2		
I _{CCA} + I _{CCB}		V _I = V _{CCI} or GND, I _O = 0	1.2 V to 3.6 V	1.2 V to 3.6 V				20		μA
C _i	Control inputs	V _I = 3.3 V or GND	3.3 V	3.3 V		2.5				pF
C _{io}	A or B port	V _O = 3.3 V or GND	3.3 V	3.3 V		6				pF

(1) V_{CCO} is the V_{CC} associated with the output port.

(2) V_{CCI} is the V_{CC} associated with the input port.

Switching Characteristics

over recommended operating free-air temperature range, V_{CCA} = 1.2 V (see [Figure 11](#))

PARAMETER	FROM (INPUT)	TO (OUTPUT)	V _{CCB} = 1.2 V	V _{CCB} = 1.5 V	V _{CCB} = 1.8 V	V _{CCB} = 2.5 V	V _{CCB} = 3.3 V	UNIT
			TYP	TYP	TYP	TYP	TYP	
t _{PLH}	A	B	3.3	2.7	2.4	2.3	2.4	ns
t _{PHL}			3.3	2.7	2.4	2.3	2.4	
t _{PLH}	B	A	3.3	3.1	2.9	2.8	2.7	ns
t _{PHL}			3.3	3.1	2.9	2.8	2.7	
t _{PHZ}	DIR	A	5.1	5.2	5.3	5.2	3.7	ns
t _{PLZ}			5.1	5.2	5.3	5.2	3.7	
t _{PHZ}	DIR	B	5.3	4.3	4	3.3	3.7	ns
t _{PLZ}			5.3	4.3	4	3.3	3.7	
t _{PZH} ⁽¹⁾	DIR	A	8.5	6.9	6.4	5.5	6.1	ns
t _{PZL} ⁽¹⁾			8.5	6.9	6.4	5.5	6.1	
t _{PZH} ⁽¹⁾	DIR	B	8.3	7.8	7.7	7.5	5.9	ns
t _{PZL} ⁽¹⁾			8.3	7.8	7.7	7.5	5.9	

(1) The enable time is a calculated value, derived using the formula shown in the *enable times* section.

Switching Characteristics

over recommended operating free-air temperature range, $V_{CCA} = 1.5 \text{ V} \pm 0.1 \text{ V}$ (see Figure 11)

PARAMETER	FROM (INPUT)	TO (OUTPUT)	$V_{CCB} = 1.2 \text{ V}$	$V_{CCB} = 1.5 \text{ V} \pm 0.1 \text{ V}$		$V_{CCB} = 1.8 \text{ V} \pm 0.15 \text{ V}$		$V_{CCB} = 2.5 \text{ V} \pm 0.2 \text{ V}$		$V_{CCB} = 3.3 \text{ V} \pm 0.3 \text{ V}$		UNIT
			TYP	MIN	MAX	MIN	MAX	MIN	MAX	MIN	MAX	
t_{PLH}	A	B	2.9	0.7	5.6	0.6	5.2	0.5	4.2	0.5	3.8	ns
t_{PHL}			2.9	0.7	5.6	0.6	5.2	0.5	4.2	0.5	3.8	
t_{PLH}	B	A	2.6	0.6	5.5	0.4	5.3	0.3	4.9	0.3	4.8	ns
t_{PHL}			2.6	0.6	5.5	0.4	5.3	0.3	4.9	0.3	4.8	
t_{PHZ}	DIR	A	3.8	1.6	6.7	1.5	6.8	0.3	6.9	0.9	6.9	ns
t_{PLZ}			3.8	1.6	6.7	1.5	6.8	0.3	6.9	0.9	6.9	
t_{PHZ}	DIR	B	5.1	1.8	8.1	1.6	7.1	1.1	4.7	1.4	4.5	ns
t_{PLZ}			5.1	1.8	8.1	1.6	7.1	1.1	4.7	1.4	4.5	
$t_{PZH}^{(1)}$	DIR	A	7.7		13.6		12.4		9.6		9.3	ns
$t_{PZL}^{(1)}$			7.7		13.6		12.4		9.6		9.3	
$t_{PZH}^{(1)}$	DIR	B	6.7		12.3		12		11.1		10.7	ns
$t_{PZL}^{(1)}$			6.7		12.3		12		11.1		10.7	

(1) The enable time is a calculated value, derived using the formula shown in the *enable times* section.

Switching Characteristics

over recommended operating free-air temperature range, $V_{CCA} = 1.8 \text{ V} \pm 0.15 \text{ V}$ (see Figure 11)

PARAMETER	FROM (INPUT)	TO (OUTPUT)	$V_{CCB} = 1.2 \text{ V}$	$V_{CCB} = 1.5 \text{ V} \pm 0.1 \text{ V}$		$V_{CCB} = 1.8 \text{ V} \pm 0.15 \text{ V}$		$V_{CCB} = 2.5 \text{ V} \pm 0.2 \text{ V}$		$V_{CCB} = 3.3 \text{ V} \pm 0.3 \text{ V}$		UNIT
			TYP	MIN	MAX	MIN	MAX	MIN	MAX	MIN	MAX	
t_{PLH}	A	B	2.8	0.6	5.3	0.5	5	0.4	3.9	0.4	3.4	ns
t_{PHL}			2.8	0.6	5.3	0.5	5	0.4	3.9	0.4	3.4	
t_{PLH}	B	A	2.3	0.5	5.2	0.4	5	0.3	4.6	0.2	4.4	ns
t_{PHL}			2.3	0.5	5.2	0.4	5	0.3	4.6	0.2	4.4	
t_{PHZ}	DIR	A	3.8	1.6	5.9	1.6	5.9	1.6	5.9	0.5	6	ns
t_{PLZ}			3.8	1.6	5.9	1.6	5.9	1.6	5.9	0.5	6	
t_{PHZ}	DIR	B	5	1.8	7.7	1.4	6.8	1	4.4	1.4	4.3	ns
t_{PLZ}			5	1.89	7.7	1.4	6.8	1	4.4	1.4	4.3	
$t_{PZH}^{(1)}$	DIR	A	7.3		12.9		11.8		9		8.7	ns
$t_{PZL}^{(1)}$			7.3		12.9		11.8		9		8.7	
$t_{PZH}^{(1)}$	DIR	B	6.5		11.2		10.9		9.8		9.4	ns
$t_{PZL}^{(1)}$			6.5		11.2		10.9		9.8		9.4	

(1) The enable time is a calculated value, derived using the formula shown in the *enable times* section.

SN74AVCH1T45
SINGLE-BIT DUAL-SUPPLY BUS TRANSCEIVER
WITH CONFIGURABLE VOLTAGE TRANSLATION AND 3-STATE OUTPUTS

SCES598D–JULY 2004–REVISED JANUARY 2008

Switching Characteristics

over recommended operating free-air temperature range, $V_{CCA} = 2.5 \text{ V} \pm 0.2 \text{ V}$ (see [Figure 11](#))

PARAMETER	FROM (INPUT)	TO (OUTPUT)	$V_{CCB} = 1.2 \text{ V}$	$V_{CCB} = 1.5 \text{ V}$ 0.1 V		$V_{CCB} = 1.8 \text{ V}$ 0.15 V		$V_{CCB} = 2.5 \text{ V}$ 0.2 V		$V_{CCB} = 3.3 \text{ V}$ 0.3 V		UNIT
			TYP	MIN	MAX	MIN	MAX	MIN	MAX	MIN	MAX	
t_{PLH}	A	B	2.6	0.5	4.9	0.4	4.6	0.3	3.4	0.3	3	ns
t_{PHL}			2.6	0.5	4.9	0.4	4.6	0.3	3.4	0.3	3	
t_{PLH}	B	A	2.2	0.4	4.2	0.3	3.8	0.2	3.4	0.2	3.3	ns
t_{PHL}			2.2	0.4	4.2	0.3	3.8	0.2	3.4	0.2	3.3	
t_{PHZ}	DIR	A	2.8	0.3	3.8	0.8	3.8	0.4	3.8	0.5	3.8	ns
t_{PLZ}			2.8	0.3	3.8	0.8	3.8	0.4	3.8	0.5	3.8	
t_{PHZ}	DIR	B	4.9	2	7.6	1.5	6.5	0.6	4.1	1	4	ns
t_{PLZ}			4.9	2	7.6	1.5	6.5	0.6	4.1	1	4	
$t_{PZH}^{(1)}$	DIR	A	7.1	11.8		10.3		7.5		7.3		ns
$t_{PZL}^{(1)}$			7.1	11.8		10.3		7.5		7.3		
$t_{PZH}^{(1)}$	DIR	B	5.4	8.6		8.1		7		6.6		ns
$t_{PZL}^{(1)}$			5.4	8.6		8.1		7		6.6		

(1) The enable time is a calculated value, derived using the formula shown in the *enable times* section.

Switching Characteristics

over recommended operating free-air temperature range, $V_{CCA} = 3.3 \text{ V} \pm 0.3 \text{ V}$ (see [Figure 11](#))

PARAMETER	FROM (INPUT)	TO (OUTPUT)	$V_{CCB} = 1.2 \text{ V}$	$V_{CCB} = 1.5 \text{ V}$ 0.1 V		$V_{CCB} = 1.8 \text{ V}$ 0.15 V		$V_{CCB} = 2.5 \text{ V}$ 0.2 V		$V_{CCB} = 3.3 \text{ V}$ 0.3 V		UNIT
			TYP	MIN	MAX	MIN	MAX	MIN	MAX	MIN	MAX	
t_{PLH}	A	B	2.6	0.4	4.7	0.3	4.4	0.2	3.3	0.2	2.8	ns
t_{PHL}			2.6	0.4	4.7	0.3	4.4	0.2	3.3	0.2	2.8	
t_{PLH}	B	A	2.2	0.4	3.8	0.3	3.4	0.2	3	0.1	2.8	ns
t_{PHL}			2.2	0.4	3.8	0.3	3.4	0.2	3	0.1	2.8	
t_{PHZ}	DIR	A	3.1	1.3	4.3	1.3	4.3	1.3	4.3	1.3	4.3	ns
t_{PLZ}			3.1	1.3	4.3	1.3	4.3	1.3	4.3	1.3	4.3	
t_{PHZ}	DIR	B	4	0.7	7.4	0.6	6.5	0.7	4	1.5	3.9	ns
t_{PLZ}			4	0.7	7.4	0.6	6.5	0.7	4	1.5	3.9	
$t_{PZH}^{(1)}$	DIR	A	6.2	11.2		9.9		7		6.7		ns
$t_{PZL}^{(1)}$			6.2	11.2		9.9		7		6.7		
$t_{PZH}^{(1)}$	DIR	B	5.7	8.9		8.5		7.2		6.8		ns
$t_{PZL}^{(1)}$			5.7	8.9		8.5		7.2		6.8		

(1) The enable time is a calculated value, derived using the formula shown in the *enable times* section.

Operating Characteristics

$T_A = 25^\circ\text{C}$

PARAMETER		TEST CONDITIONS	$V_{CCA} =$ $V_{CCB} = 1.2\text{ V}$	$V_{CCA} =$ $V_{CCB} = 1.5\text{ V}$	$V_{CCA} =$ $V_{CCB} = 1.8\text{ V}$	$V_{CCA} =$ $V_{CCB} = 2.5\text{ V}$	$V_{CCA} =$ $V_{CCB} = 3.3\text{ V}$	UNIT
			TYP	TYP	TYP	TYP	TYP	
$C_{pdA}^{(1)}$	A-port input, B-port output	$C_L = 0\text{ pF},$ $f = 10\text{ MHz},$ $t_r = t_f = 1\text{ ns}$	3	3	3	3	4	pF
	B-port input, A-port output		14	14	14	15	16	
$C_{pdB}^{(1)}$	A-port input, B-port output	$C_L = 0\text{ pF},$ $f = 10\text{ MHz},$ $t_r = t_f = 1\text{ ns}$	14	14	14	15	16	pF
	B-port input, A-port output		3	3	3	3	4	

(1) Power-dissipation capacitance per transceiver

Power-Up Considerations

A proper power-up sequence always should be followed to avoid excessive supply current, bus contention, oscillations, or other anomalies. To guard against such power-up problems, take the following precautions:

1. Connect ground before any supply voltage is applied.
2. Power up V_{CCA} .
3. V_{CCB} can be ramped up along with or after V_{CCA} .

Table 1. Typical Total Static Power Consumption ($I_{CCA} + I_{CCB}$)

V_{CCB}	V_{CCA}						UNIT
	0 V	1.2 V	1.5 V	1.8 V	2.5 V	3.3 V	
0 V	0	<0.5	<0.5	<0.5	<0.5	<0.5	μA
1.2 V	<0.5	<1	<1	<1	<1	1	
1.5 V	<0.5	<1	<1	<1	<1	1	
1.8 V	<0.5	<1	<1	<1	<1	<1	
2.5 V	<0.5	1	<1	<1	<1	<1	
3.3 V	<0.5	1	<1	<1	<1	<1	

TYPICAL CHARACTERISTICS

TYPICAL PROPAGATION DELAY (A to B) vs LOAD CAPACITANCE,
 $T_A = 25^\circ\text{C}$, $V_{CCA} = 1.2\text{ V}$

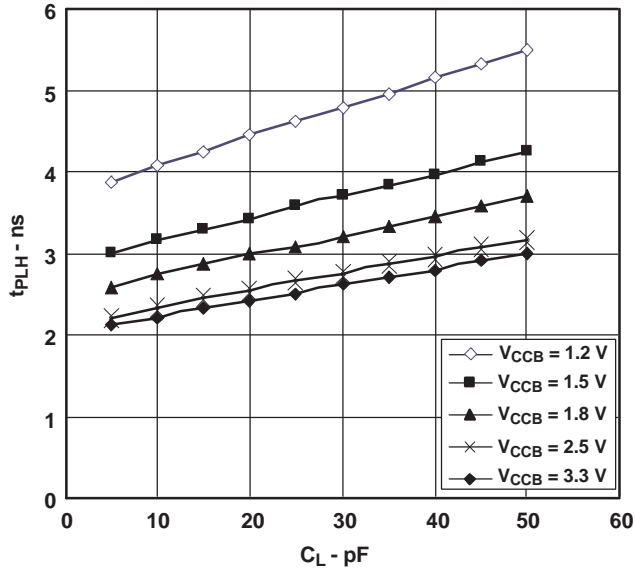

Figure 1.

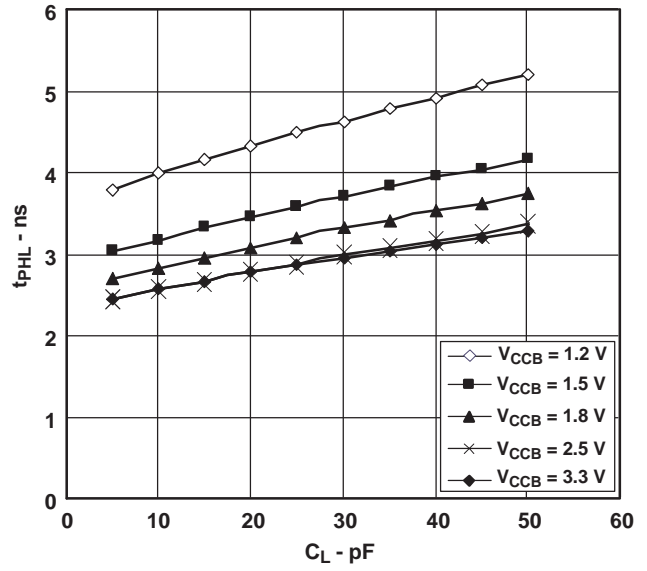

Figure 2.

TYPICAL PROPAGATION DELAY (A to B) vs LOAD CAPACITANCE,
 $T_A = 25^\circ\text{C}$, $V_{CCA} = 1.5\text{ V}$

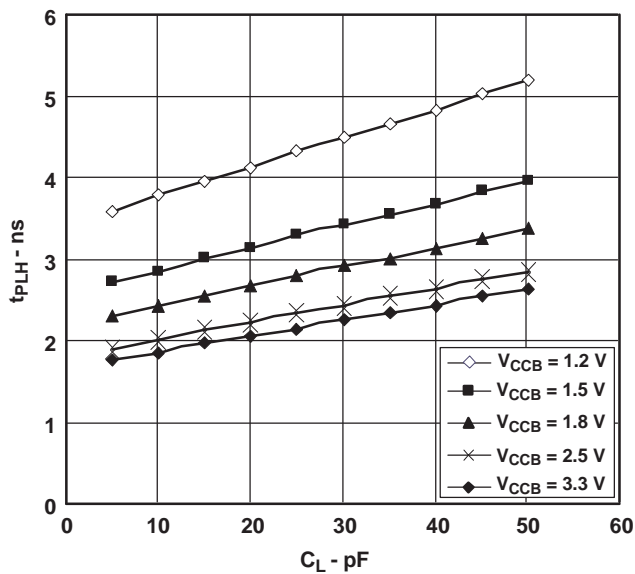

Figure 3.

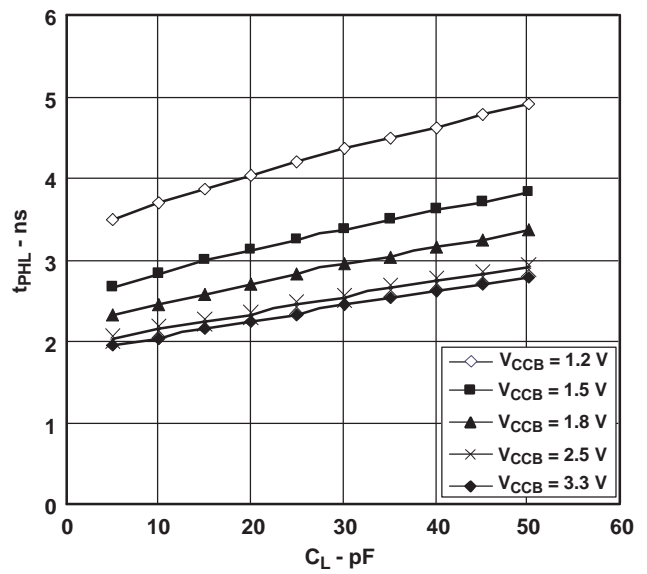

Figure 4.

TYPICAL CHARACTERISTICS

TYPICAL PROPAGATION DELAY (A to B) vs LOAD CAPACITANCE,
 $T_A = 25^\circ\text{C}, V_{CCA} = 1.8\text{ V}$

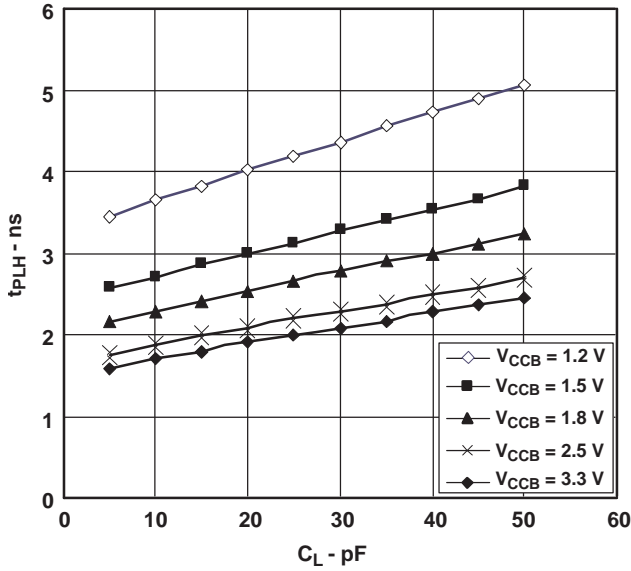

Figure 5.

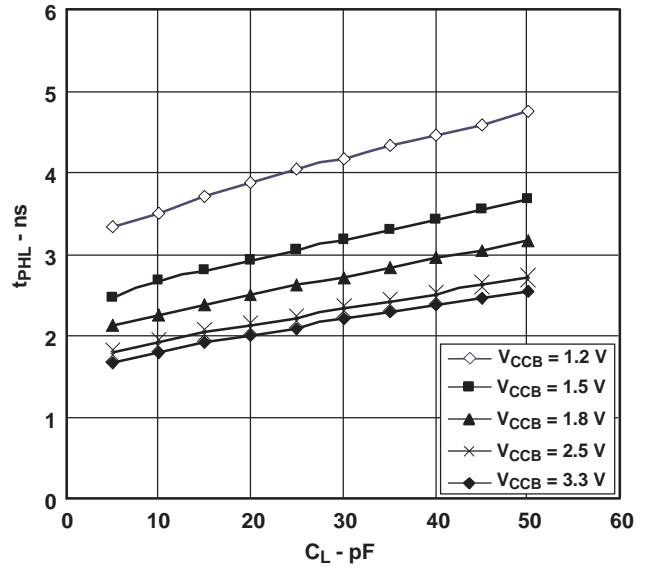

Figure 6.

TYPICAL PROPAGATION DELAY (A to B) vs LOAD CAPACITANCE,
 $T_A = 25^\circ\text{C}, V_{CCA} = 2.5\text{ V}$

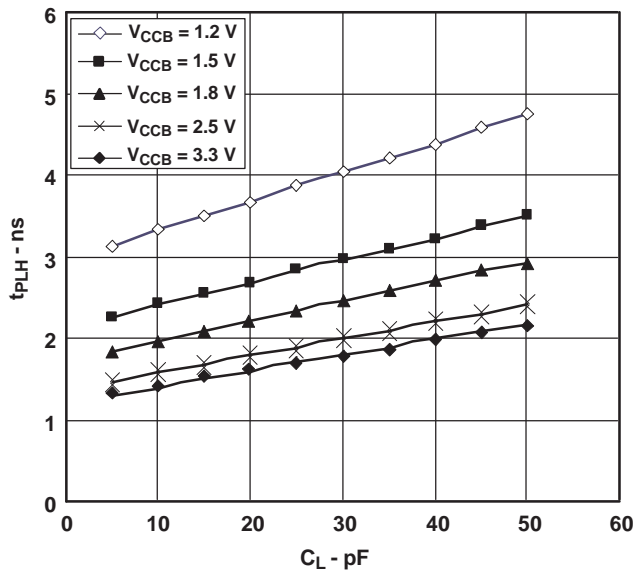

Figure 7.

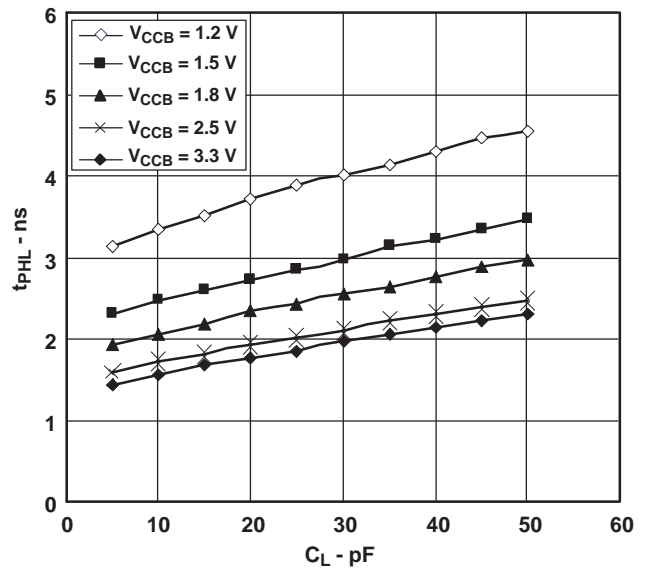

Figure 8.

TYPICAL CHARACTERISTICS

TYPICAL PROPAGATION DELAY (A to B) vs LOAD CAPACITANCE,
 $T_A = 25^\circ\text{C}$, $V_{CCA} = 3.3\text{ V}$

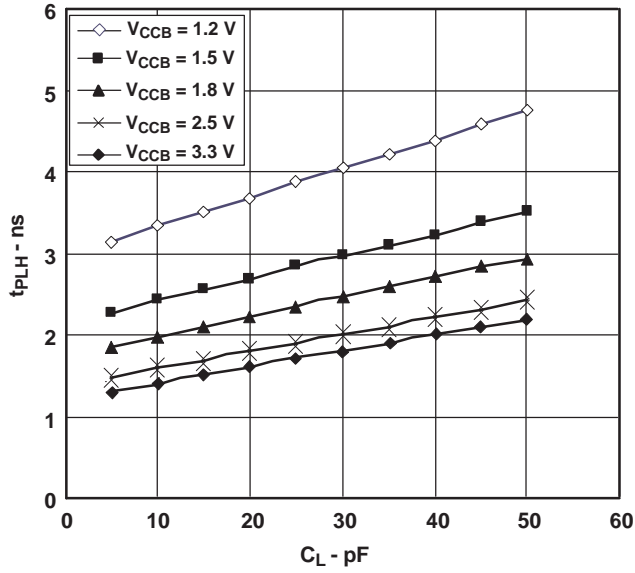

Figure 9.

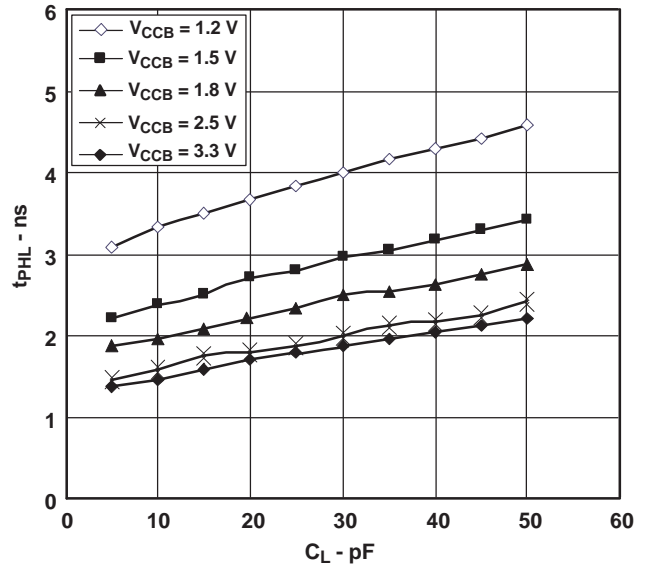
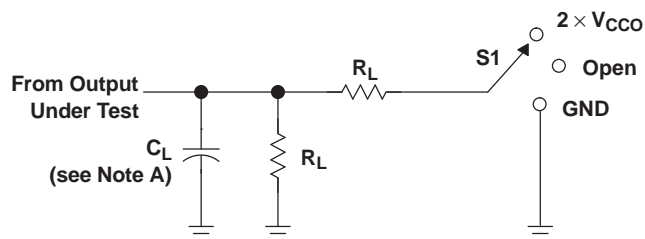

Figure 10.

PARAMETER MEASUREMENT INFORMATION



LOAD CIRCUIT

TEST	S1
t_{pd}	Open
t_{PLZ}/t_{PZL}	$2 \times V_{CCO}$
t_{PHZ}/t_{PZH}	GND

V_{CCO}	C_L	R_L	V_{TP}
1.2 V	15 pF	2 k Ω	0.1 V
1.5 V \pm 0.1 V	15 pF	2 k Ω	0.1 V
1.8 V \pm 0.15 V	15 pF	2 k Ω	0.15 V
2.5 V \pm 0.2 V	15 pF	2 k Ω	0.15 V
3.3 V \pm 0.3 V	15 pF	2 k Ω	0.3 V

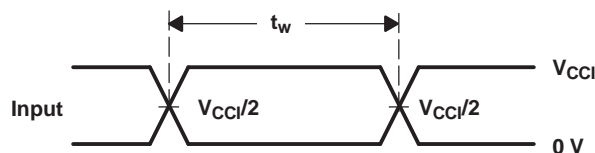

VOLTAGE WAVEFORMS
PULSE DURATION

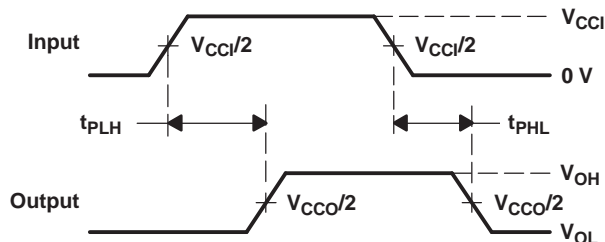

VOLTAGE WAVEFORMS
PROPAGATION DELAY TIMES

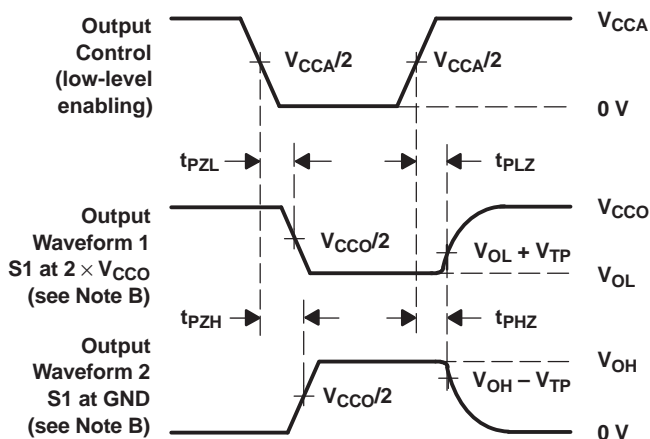

VOLTAGE WAVEFORMS
ENABLE AND DISABLE TIMES

- NOTES:
- C_L includes probe and jig capacitance.
 - Waveform 1 is for an output with internal conditions such that the output is low, except when disabled by the output control. Waveform 2 is for an output with internal conditions such that the output is high, except when disabled by the output control.
 - All input pulses are supplied by generators having the following characteristics: PRR \leq 10 MHz, $Z_O = 50 \Omega$, $dv/dt \geq 1$ V/ns.
 - The outputs are measured one at a time, with one transition per measurement.
 - t_{PLZ} and t_{PHZ} are the same as t_{dis} .
 - t_{PZL} and t_{PZH} are the same as t_{en} .
 - t_{PLH} and t_{PHL} are the same as t_{pd} .
 - V_{CCi} is the V_{CC} associated with the input port.
 - V_{CCO} is the V_{CC} associated with the output port.

Figure 11. Load Circuit and Voltage Waveforms

APPLICATION INFORMATION

Figure 12 shows an example of the SN74AVCH1T45 being used in a unidirectional logic level-shifting application.

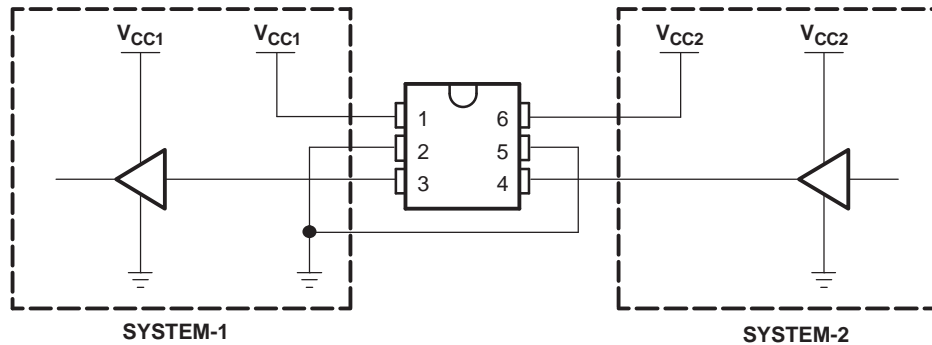

PIN	NAME	FUNCTION	DESCRIPTION
1	V _{CCA}	V _{CC1}	SYSTEM-1 supply voltage (1.2 V to 3.36 V)
2	GND	GND	Device GND
3	A	OUT	Output level depends on V _{CC1} voltage.
4	B	IN	Input threshold value depends on V _{CC2} voltage.
5	DIR	DIR	GND (low level) determines B-port to A-port direction.
6	V _{CCB}	V _{CC2}	SYSTEM-2 supply voltage (1.2 V to 3.6 V)

Figure 12. Unidirectional Logic Level-Shifting Application

APPLICATION INFORMATION

Figure 13 shows the SN74AVCH1T45 being used in a bidirectional logic level-shifting application. Since the SN74AVCH1T45 does not have an output-enable (OE) pin, the system designer should take precautions to avoid bus contention between SYSTEM-1 and SYSTEM-2 when changing directions.

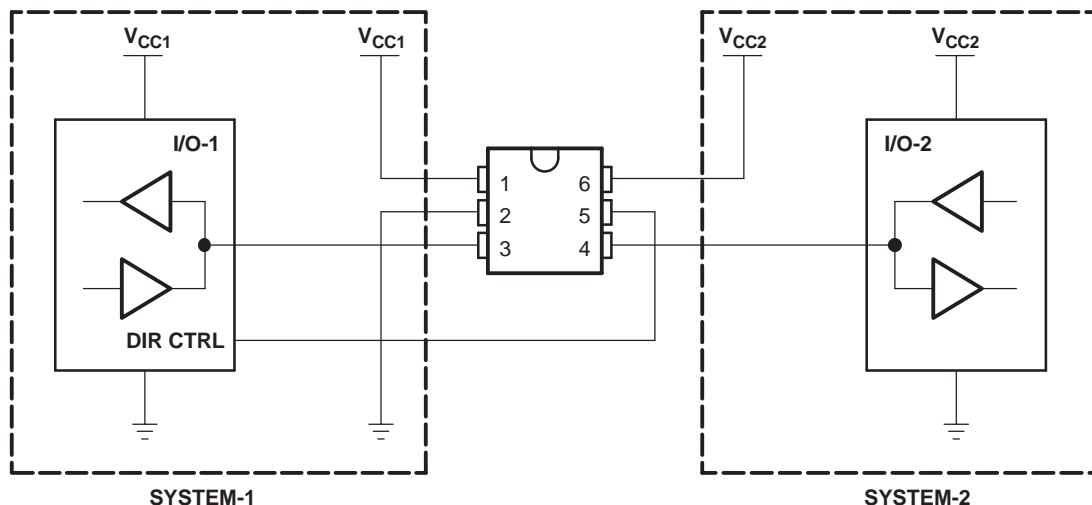

STATE	DIR CTRL	I/O-1	I/O-2	DESCRIPTION
1	H	Out	In	SYSTEM-1 data to SYSTEM-2
2	H	Hi-Z	Hi-Z	SYSTEM-2 is getting ready to send data to SYSTEM-1. I/O-1 and I/O-2 are disabled. The bus-line state depends on bus hold.
3	L	Hi-Z	Hi-Z	DIR bit is flipped. I/O-1 and I/O-2 still are disabled. The bus-line state depends on bus hold.
4	L	Out	In	SYSTEM-2 data to SYSTEM-1

Figure 13. Bidirectional Logic Level-Shifting Application

Following is a sequence that illustrates data transmission from SYSTEM-1 to SYSTEM-2 and then from SYSTEM-2 to SYSTEM-1.

Enable Times

Calculate the enable times for the SN74AVCH1T45 using the following formulas:

- $t_{PZH} \text{ (DIR to A)} = t_{PLZ} \text{ (DIR to B)} + t_{PLH} \text{ (B to A)}$
- $t_{PZL} \text{ (DIR to A)} = t_{PHZ} \text{ (DIR to B)} + t_{PHL} \text{ (B to A)}$
- $t_{PZH} \text{ (DIR to B)} = t_{PLZ} \text{ (DIR to A)} + t_{PLH} \text{ (A to B)}$
- $t_{PZL} \text{ (DIR to B)} = t_{PHZ} \text{ (DIR to A)} + t_{PHL} \text{ (A to B)}$

In a bidirectional application, these enable times provide the maximum delay from the time the DIR bit is switched until an output is expected. For example, if the SN74AVCH1T45 initially is transmitting from A to B, then the DIR bit is switched; the B port of the device must be disabled before presenting it with an input. After the B port has been disabled, an input signal applied to it appears on the corresponding A port after the specified propagation delay.

PACKAGING INFORMATION

Orderable Device	Status ⁽¹⁾	Package Type	Package Drawing	Pins	Package Qty	Eco Plan ⁽²⁾	Lead/ Ball Finish	MSL Peak Temp ⁽³⁾	Samples (Requires Login)
74AVCH1T45DBVRE4	ACTIVE	SOT-23	DBV	6	3000	Green (RoHS & no Sb/Br)	CU NIPDAU	Level-1-260C-UNLIM	
74AVCH1T45DBVRG4	ACTIVE	SOT-23	DBV	6	3000	Green (RoHS & no Sb/Br)	CU NIPDAU	Level-1-260C-UNLIM	
74AVCH1T45DBVTE4	ACTIVE	SOT-23	DBV	6	250	Green (RoHS & no Sb/Br)	CU NIPDAU	Level-1-260C-UNLIM	
74AVCH1T45DBVTG4	ACTIVE	SOT-23	DBV	6	250	Green (RoHS & no Sb/Br)	CU NIPDAU	Level-1-260C-UNLIM	
74AVCH1T45DCKRE4	ACTIVE	SC70	DCK	6	3000	Green (RoHS & no Sb/Br)	CU NIPDAU	Level-1-260C-UNLIM	
74AVCH1T45DCKRG4	ACTIVE	SC70	DCK	6	3000	Green (RoHS & no Sb/Br)	CU NIPDAU	Level-1-260C-UNLIM	
74AVCH1T45DCKTE4	ACTIVE	SC70	DCK	6	250	Green (RoHS & no Sb/Br)	CU NIPDAU	Level-1-260C-UNLIM	
74AVCH1T45DCKTG4	ACTIVE	SC70	DCK	6	250	Green (RoHS & no Sb/Br)	CU NIPDAU	Level-1-260C-UNLIM	
SN74AVCH1T45DBVR	ACTIVE	SOT-23	DBV	6	3000	Green (RoHS & no Sb/Br)	CU NIPDAU	Level-1-260C-UNLIM	
SN74AVCH1T45DBVT	ACTIVE	SOT-23	DBV	6	250	Green (RoHS & no Sb/Br)	CU NIPDAU	Level-1-260C-UNLIM	
SN74AVCH1T45DCKR	ACTIVE	SC70	DCK	6	3000	Green (RoHS & no Sb/Br)	CU NIPDAU	Level-1-260C-UNLIM	
SN74AVCH1T45DCKT	ACTIVE	SC70	DCK	6	250	Green (RoHS & no Sb/Br)	CU NIPDAU	Level-1-260C-UNLIM	
SN74AVCH1T45YZPR	ACTIVE	DSBGA	YZP	6	3000	Green (RoHS & no Sb/Br)	SNAGCU	Level-1-260C-UNLIM	

⁽¹⁾ The marketing status values are defined as follows:

ACTIVE: Product device recommended for new designs.

LIFEBUY: TI has announced that the device will be discontinued, and a lifetime-buy period is in effect.

NRND: Not recommended for new designs. Device is in production to support existing customers, but TI does not recommend using this part in a new design.

PREVIEW: Device has been announced but is not in production. Samples may or may not be available.

OBSOLETE: TI has discontinued the production of the device.

⁽²⁾ Eco Plan - The planned eco-friendly classification: Pb-Free (RoHS), Pb-Free (RoHS Exempt), or Green (RoHS & no Sb/Br) - please check <http://www.ti.com/productcontent> for the latest availability information and additional product content details.

TBD: The Pb-Free/Green conversion plan has not been defined.

Pb-Free (RoHS): TI's terms "Lead-Free" or "Pb-Free" mean semiconductor products that are compatible with the current RoHS requirements for all 6 substances, including the requirement that lead not exceed 0.1% by weight in homogeneous materials. Where designed to be soldered at high temperatures, TI Pb-Free products are suitable for use in specified lead-free processes.

Pb-Free (RoHS Exempt): This component has a RoHS exemption for either 1) lead-based flip-chip solder bumps used between the die and package, or 2) lead-based die adhesive used between the die and leadframe. The component is otherwise considered Pb-Free (RoHS compatible) as defined above.

Green (RoHS & no Sb/Br): TI defines "Green" to mean Pb-Free (RoHS compatible), and free of Bromine (Br) and Antimony (Sb) based flame retardants (Br or Sb do not exceed 0.1% by weight in homogeneous material)

⁽³⁾ MSL, Peak Temp. -- The Moisture Sensitivity Level rating according to the JEDEC industry standard classifications, and peak solder temperature.

Important Information and Disclaimer: The information provided on this page represents TI's knowledge and belief as of the date that it is provided. TI bases its knowledge and belief on information provided by third parties, and makes no representation or warranty as to the accuracy of such information. Efforts are underway to better integrate information from third parties. TI has taken and continues to take reasonable steps to provide representative and accurate information but may not have conducted destructive testing or chemical analysis on incoming materials and chemicals. TI and TI suppliers consider certain information to be proprietary, and thus CAS numbers and other limited information may not be available for release.

In no event shall TI's liability arising out of such information exceed the total purchase price of the TI part(s) at issue in this document sold by TI to Customer on an annual basis.

TAPE AND REEL INFORMATION
REEL DIMENSIONS

TAPE DIMENSIONS

A0	Dimension designed to accommodate the component width
B0	Dimension designed to accommodate the component length
K0	Dimension designed to accommodate the component thickness
W	Overall width of the carrier tape
P1	Pitch between successive cavity centers

TAPE AND REEL INFORMATION

*All dimensions are nominal

Device	Package Type	Package Drawing	Pins	SPQ	Reel Diameter (mm)	Reel Width W1 (mm)	A0 (mm)	B0 (mm)	K0 (mm)	P1 (mm)	W (mm)	Pin1 Quadrant
SN74AVCH1T45DBVR	SOT-23	DBV	6	3000	180.0	8.4	3.23	3.17	1.37	4.0	8.0	Q3
SN74AVCH1T45DBVT	SOT-23	DBV	6	250	180.0	8.4	3.23	3.17	1.37	4.0	8.0	Q3
SN74AVCH1T45DCKR	SC70	DCK	6	3000	180.0	8.4	2.3	2.52	1.2	4.0	8.0	Q3
SN74AVCH1T45DCKR	SC70	DCK	6	3000	180.0	8.4	2.25	2.4	1.22	4.0	8.0	Q3
SN74AVCH1T45DCKT	SC70	DCK	6	250	180.0	8.4	2.25	2.4	1.22	4.0	8.0	Q3
SN74AVCH1T45DCKT	SC70	DCK	6	250	180.0	8.4	2.3	2.52	1.2	4.0	8.0	Q3
SN74AVCH1T45YZPR	DSBGA	YZP	6	3000	178.0	9.2	1.02	1.52	0.63	4.0	8.0	Q1

TAPE AND REEL BOX DIMENSIONS

*All dimensions are nominal

Device	Package Type	Package Drawing	Pins	SPQ	Length (mm)	Width (mm)	Height (mm)
SN74AVCH1T45DBVR	SOT-23	DBV	6	3000	202.0	201.0	28.0
SN74AVCH1T45DBVT	SOT-23	DBV	6	250	202.0	201.0	28.0
SN74AVCH1T45DCKR	SC70	DCK	6	3000	214.0	199.0	55.0
SN74AVCH1T45DCKR	SC70	DCK	6	3000	202.0	201.0	28.0
SN74AVCH1T45DCKT	SC70	DCK	6	250	202.0	201.0	28.0
SN74AVCH1T45DCKT	SC70	DCK	6	250	214.0	199.0	55.0
SN74AVCH1T45YZPR	DSBGA	YZP	6	3000	220.0	220.0	35.0

DBV (R-PDSO-G6)

PLASTIC SMALL-OUTLINE PACKAGE



- NOTES:
- A. All linear dimensions are in millimeters.
 - B. This drawing is subject to change without notice.
 - C. Body dimensions do not include mold flash or protrusion. Mold flash and protrusion shall not exceed 0.15 per side.
 - D. Leads 1,2,3 may be wider than leads 4,5,6 for package orientation.
- \triangleleft Falls within JEDEC MO-178 Variation AB, except minimum lead width.

DBV (R-PDSO-G6)

PLASTIC SMALL OUTLINE



4209593-4/C 08/11

- NOTES:
- A. All linear dimensions are in millimeters.
 - B. This drawing is subject to change without notice.
 - C. Customers should place a note on the circuit board fabrication drawing not to alter the center solder mask defined pad.
 - D. Publication IPC-7351 is recommended for alternate designs.
 - E. Laser cutting apertures with trapezoidal walls and also rounding corners will offer better paste release. Customers should contact their board assembly site for stencil design recommendations. Example stencil design based on a 50% volumetric metal load solder paste. Refer to IPC-7525 for other stencil recommendations.

DCK (R-PDSO-G6)

PLASTIC SMALL-OUTLINE PACKAGE



- NOTES:
- All linear dimensions are in millimeters.
 - This drawing is subject to change without notice.
 - Body dimensions do not include mold flash or protrusion. Mold flash and protrusion shall not exceed 0.15 per side.
 - Falls within JEDEC MO-203 variation AB.

DCK (R-PDSO-G6)

PLASTIC SMALL OUTLINE



- NOTES:
- All linear dimensions are in millimeters.
 - This drawing is subject to change without notice.
 - Customers should place a note on the circuit board fabrication drawing not to alter the center solder mask defined pad.
 - Publication IPC-7351 is recommended for alternate designs.
 - Laser cutting apertures with trapezoidal walls and also rounding corners will offer better paste release. Customers should contact their board assembly site for stencil design recommendations. Example stencil design based on a 50% volumetric metal load solder paste. Refer to IPC-7525 for other stencil recommendations.

YZP (R-XBGA-N6)

DIE-SIZE BALL GRID ARRAY

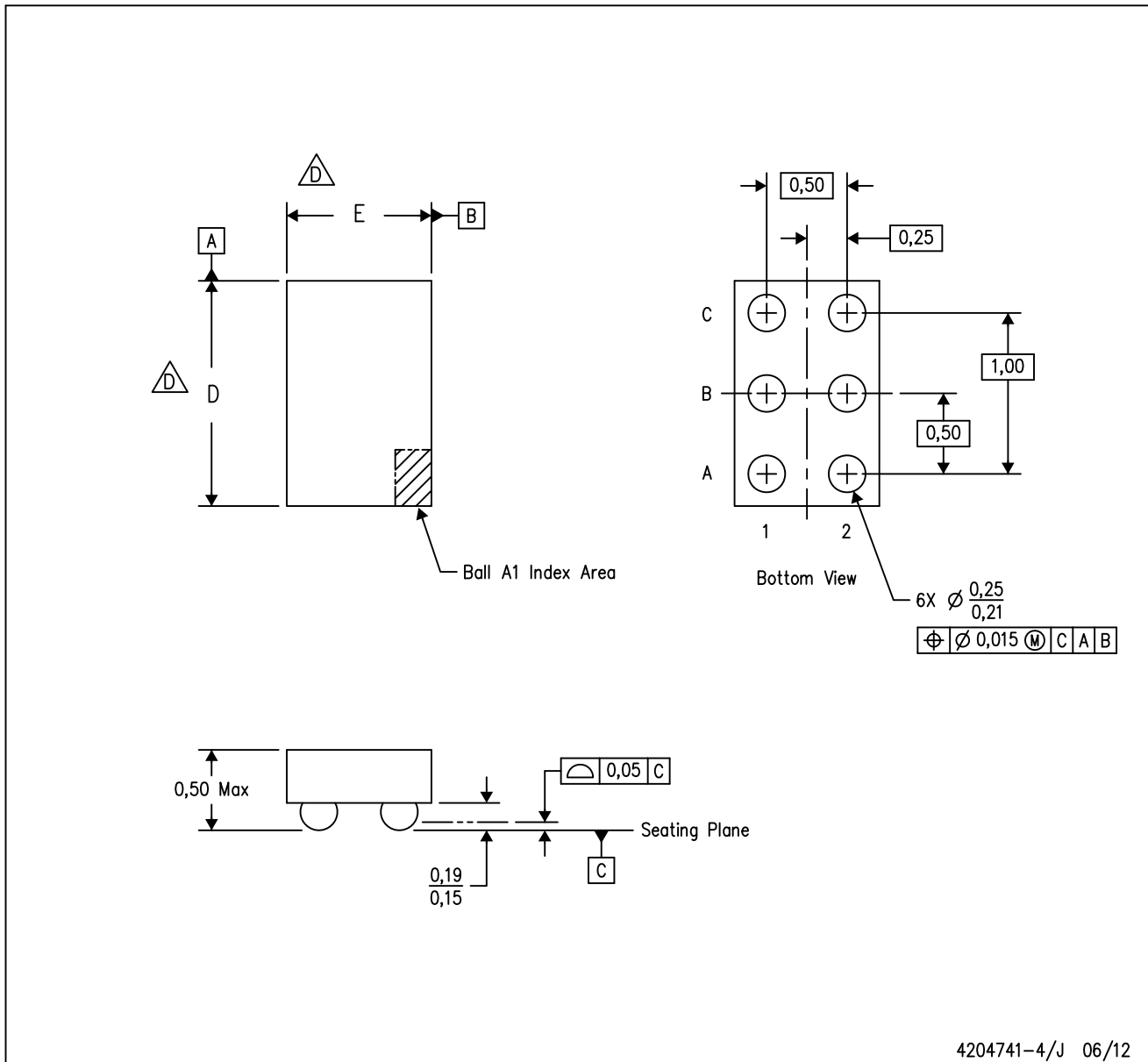

- NOTES:
- A. All linear dimensions are in millimeters. Dimensioning and tolerancing per ASME Y14.5M-1994.
 - B. This drawing is subject to change without notice.
 - C. NanoFree™ package configuration.
 - The package size (Dimension D and E) of a particular device is specified in the device Product Data Sheet version of this drawing, in case it cannot be found in the product data sheet please contact a local TI representative.
 - E. This package is a Pb-free solder ball design. Refer to the 6 YEP package (drawing 4204725) for tin-lead (SnPb).

NanoFree is a trademark of Texas Instruments.

PACKAGING INFORMATION

Orderable Device	Status (1)	Package Type	Package Drawing	Pins	Package Qty	Eco Plan (2)	Lead/Ball Finish (6)	MSL Peak Temp (3)	Op Temp (°C)	Device Marking (4/5)	Samples
74AVCH1T45DBVRE4	ACTIVE	SOT-23	DBV	6	3000	Green (RoHS & no Sb/Br)	CU NIPDAU	Level-1-260C-UNLIM	-40 to 85	(ET1F ~ ET1R)	Samples
74AVCH1T45DBVRG4	ACTIVE	SOT-23	DBV	6	3000	Green (RoHS & no Sb/Br)	CU NIPDAU	Level-1-260C-UNLIM	-40 to 85	(ET1F ~ ET1R)	Samples
74AVCH1T45DBVTG4	ACTIVE	SOT-23	DBV	6	250	Green (RoHS & no Sb/Br)	CU NIPDAU	Level-1-260C-UNLIM	-40 to 85	(ET1F ~ ET1R)	Samples
74AVCH1T45DCKRE4	ACTIVE	SC70	DCK	6	3000	Green (RoHS & no Sb/Br)	CU NIPDAU	Level-1-260C-UNLIM	-40 to 85	(TFF ~ TFR)	Samples
74AVCH1T45DCKRG4	ACTIVE	SC70	DCK	6	3000	Green (RoHS & no Sb/Br)	CU NIPDAU	Level-1-260C-UNLIM	-40 to 85	(TFF ~ TFR)	Samples
74AVCH1T45DCKTG4	ACTIVE	SC70	DCK	6	250	Green (RoHS & no Sb/Br)	CU NIPDAU	Level-1-260C-UNLIM	-40 to 85	(TFF ~ TFR)	Samples
SN74AVCH1T45DBVR	ACTIVE	SOT-23	DBV	6	3000	Green (RoHS & no Sb/Br)	CU NIPDAU	Level-1-260C-UNLIM	-40 to 85	(ET1F ~ ET1R)	Samples
SN74AVCH1T45DBVT	ACTIVE	SOT-23	DBV	6	250	Green (RoHS & no Sb/Br)	CU NIPDAU	Level-1-260C-UNLIM	-40 to 85	(ET1F ~ ET1R)	Samples
SN74AVCH1T45DCKR	ACTIVE	SC70	DCK	6	3000	Green (RoHS & no Sb/Br)	CU NIPDAU	Level-1-260C-UNLIM	-40 to 85	(TFF ~ TFR)	Samples
SN74AVCH1T45DCKT	ACTIVE	SC70	DCK	6	250	Green (RoHS & no Sb/Br)	CU NIPDAU	Level-1-260C-UNLIM	-40 to 85	(TFF ~ TFR)	Samples
SN74AVCH1T45YZPR	ACTIVE	DSBGA	YZP	6	3000	Green (RoHS & no Sb/Br)	SNAGCU	Level-1-260C-UNLIM	-40 to 85	(TE2 ~ TE7 ~ TEN)	Samples

(1) The marketing status values are defined as follows:

ACTIVE: Product device recommended for new designs.

LIFEBUY: TI has announced that the device will be discontinued, and a lifetime-buy period is in effect.

NRND: Not recommended for new designs. Device is in production to support existing customers, but TI does not recommend using this part in a new design.

PREVIEW: Device has been announced but is not in production. Samples may or may not be available.

OBSOLETE: TI has discontinued the production of the device.

(2) Eco Plan - The planned eco-friendly classification: Pb-Free (RoHS), Pb-Free (RoHS Exempt), or Green (RoHS & no Sb/Br) - please check <http://www.ti.com/productcontent> for the latest availability information and additional product content details.

TBD: The Pb-Free/Green conversion plan has not been defined.

Pb-Free (RoHS): TI's terms "Lead-Free" or "Pb-Free" mean semiconductor products that are compatible with the current RoHS requirements for all 6 substances, including the requirement that lead not exceed 0.1% by weight in homogeneous materials. Where designed to be soldered at high temperatures, TI Pb-Free products are suitable for use in specified lead-free processes.

Pb-Free (RoHS Exempt): This component has a RoHS exemption for either 1) lead-based flip-chip solder bumps used between the die and package, or 2) lead-based die adhesive used between the die and leadframe. The component is otherwise considered Pb-Free (RoHS compatible) as defined above.

Green (RoHS & no Sb/Br): TI defines "Green" to mean Pb-Free (RoHS compatible), and free of Bromine (Br) and Antimony (Sb) based flame retardants (Br or Sb do not exceed 0.1% by weight in homogeneous material)

⁽³⁾ MSL, Peak Temp. - The Moisture Sensitivity Level rating according to the JEDEC industry standard classifications, and peak solder temperature.

⁽⁴⁾ There may be additional marking, which relates to the logo, the lot trace code information, or the environmental category on the device.

⁽⁵⁾ Multiple Device Markings will be inside parentheses. Only one Device Marking contained in parentheses and separated by a "~" will appear on a device. If a line is indented then it is a continuation of the previous line and the two combined represent the entire Device Marking for that device.

⁽⁶⁾ Lead/Ball Finish - Orderable Devices may have multiple material finish options. Finish options are separated by a vertical ruled line. Lead/Ball Finish values may wrap to two lines if the finish value exceeds the maximum column width.

Important Information and Disclaimer: The information provided on this page represents TI's knowledge and belief as of the date that it is provided. TI bases its knowledge and belief on information provided by third parties, and makes no representation or warranty as to the accuracy of such information. Efforts are underway to better integrate information from third parties. TI has taken and continues to take reasonable steps to provide representative and accurate information but may not have conducted destructive testing or chemical analysis on incoming materials and chemicals. TI and TI suppliers consider certain information to be proprietary, and thus CAS numbers and other limited information may not be available for release.

In no event shall TI's liability arising out of such information exceed the total purchase price of the TI part(s) at issue in this document sold by TI to Customer on an annual basis.

TAPE AND REEL INFORMATION

QUADRANT ASSIGNMENTS FOR PIN 1 ORIENTATION IN TAPE

*All dimensions are nominal

Device	Package Type	Package Drawing	Pins	SPQ	Reel Diameter (mm)	Reel Width W1 (mm)	A0 (mm)	B0 (mm)	K0 (mm)	P1 (mm)	W (mm)	Pin1 Quadrant
SN74AVCH1T45DBVR	SOT-23	DBV	6	3000	180.0	8.4	3.23	3.17	1.37	4.0	8.0	Q3
SN74AVCH1T45DBVT	SOT-23	DBV	6	250	180.0	8.4	3.23	3.17	1.37	4.0	8.0	Q3
SN74AVCH1T45DCKR	SC70	DCK	6	3000	180.0	8.4	2.3	2.52	1.2	4.0	8.0	Q3
SN74AVCH1T45DCKR	SC70	DCK	6	3000	180.0	8.4	2.41	2.41	1.2	4.0	8.0	Q3
SN74AVCH1T45DCKT	SC70	DCK	6	250	180.0	8.4	2.41	2.41	1.2	4.0	8.0	Q3
SN74AVCH1T45YZPR	DSBGA	YZP	6	3000	178.0	9.2	1.02	1.52	0.63	4.0	8.0	Q1

TAPE AND REEL BOX DIMENSIONS

*All dimensions are nominal

Device	Package Type	Package Drawing	Pins	SPQ	Length (mm)	Width (mm)	Height (mm)
SN74AVCH1T45DBVR	SOT-23	DBV	6	3000	202.0	201.0	28.0
SN74AVCH1T45DBVT	SOT-23	DBV	6	250	202.0	201.0	28.0
SN74AVCH1T45DCKR	SC70	DCK	6	3000	214.0	199.0	55.0
SN74AVCH1T45DCKR	SC70	DCK	6	3000	202.0	201.0	28.0
SN74AVCH1T45DCKT	SC70	DCK	6	250	202.0	201.0	28.0
SN74AVCH1T45YZPR	DSBGA	YZP	6	3000	220.0	220.0	35.0

MECHANICAL DATA

DBV (R-PDSO-G6)

PLASTIC SMALL-OUTLINE PACKAGE



- NOTES:
- All linear dimensions are in millimeters.
 - This drawing is subject to change without notice.
 - Body dimensions do not include mold flash or protrusion. Mold flash and protrusion shall not exceed 0.15 per side.
 - Leads 1,2,3 may be wider than leads 4,5,6 for package orientation.
- ⚠ Falls within JEDEC MO-178 Variation AB, except minimum lead width.

DBV (R-PDSO-G6)

PLASTIC SMALL OUTLINE



4209593-4/C 08/11

- NOTES:
- A. All linear dimensions are in millimeters.
 - B. This drawing is subject to change without notice.
 - C. Customers should place a note on the circuit board fabrication drawing not to alter the center solder mask defined pad.
 - D. Publication IPC-7351 is recommended for alternate designs.
 - E. Laser cutting apertures with trapezoidal walls and also rounding corners will offer better paste release. Customers should contact their board assembly site for stencil design recommendations. Example stencil design based on a 50% volumetric metal load solder paste. Refer to IPC-7525 for other stencil recommendations.

DCK (R-PDSO-G6)

PLASTIC SMALL-OUTLINE PACKAGE



- NOTES:
- A. All linear dimensions are in millimeters.
 - B. This drawing is subject to change without notice.
 - C. Body dimensions do not include mold flash or protrusion. Mold flash and protrusion shall not exceed 0.15 per side.
 - D. Falls within JEDEC MO-203 variation AB.

DCK (R-PDSO-G6)

PLASTIC SMALL OUTLINE



- NOTES:
- All linear dimensions are in millimeters.
 - This drawing is subject to change without notice.
 - Customers should place a note on the circuit board fabrication drawing not to alter the center solder mask defined pad.
 - Publication IPC-7351 is recommended for alternate designs.
 - Laser cutting apertures with trapezoidal walls and also rounding corners will offer better paste release. Customers should contact their board assembly site for stencil design recommendations. Example stencil design based on a 50% volumetric metal load solder paste. Refer to IPC-7525 for other stencil recommendations.

YZP0006



PACKAGE OUTLINE

DSBGA - 0.5 mm max height

DIE SIZE BALL GRID ARRAY



4219524/A 06/2014

NOTES:

NanoFree Is a trademark of Texas Instruments.

1. All linear dimensions are in millimeters. Any dimensions in parenthesis are for reference only. Dimensioning and tolerancing per ASME Y14.5M.
2. This drawing is subject to change without notice.
3. NanoFree™ package configuration.

EXAMPLE BOARD LAYOUT

YZP0006

DSBGA - 0.5 mm max height

DIE SIZE BALL GRID ARRAY



LAND PATTERN EXAMPLE
SCALE:40X



SOLDER MASK DETAILS
NOT TO SCALE

4219524/A 06/2014

NOTES: (continued)

- Final dimensions may vary due to manufacturing tolerance considerations and also routing constraints. For more information, see Texas Instruments literature number SBVA017 (www.ti.com/lit/sbva017).

EXAMPLE STENCIL DESIGN

YZP0006

DSBGA - 0.5 mm max height

DIE SIZE BALL GRID ARRAY



SOLDER PASTE EXAMPLE
BASED ON 0.1 mm THICK STENCIL
SCALE:40X

4219524/A 06/2014

NOTES: (continued)

5. Laser cutting apertures with trapezoidal walls and rounded corners may offer better paste release.

IMPORTANT NOTICE

Texas Instruments Incorporated and its subsidiaries (TI) reserve the right to make corrections, enhancements, improvements and other changes to its semiconductor products and services per JESD46, latest issue, and to discontinue any product or service per JESD48, latest issue. Buyers should obtain the latest relevant information before placing orders and should verify that such information is current and complete. All semiconductor products (also referred to herein as "components") are sold subject to TI's terms and conditions of sale supplied at the time of order acknowledgment.

TI warrants performance of its components to the specifications applicable at the time of sale, in accordance with the warranty in TI's terms and conditions of sale of semiconductor products. Testing and other quality control techniques are used to the extent TI deems necessary to support this warranty. Except where mandated by applicable law, testing of all parameters of each component is not necessarily performed.

TI assumes no liability for applications assistance or the design of Buyers' products. Buyers are responsible for their products and applications using TI components. To minimize the risks associated with Buyers' products and applications, Buyers should provide adequate design and operating safeguards.

TI does not warrant or represent that any license, either express or implied, is granted under any patent right, copyright, mask work right, or other intellectual property right relating to any combination, machine, or process in which TI components or services are used. Information published by TI regarding third-party products or services does not constitute a license to use such products or services or a warranty or endorsement thereof. Use of such information may require a license from a third party under the patents or other intellectual property of the third party, or a license from TI under the patents or other intellectual property of TI.

Reproduction of significant portions of TI information in TI data books or data sheets is permissible only if reproduction is without alteration and is accompanied by all associated warranties, conditions, limitations, and notices. TI is not responsible or liable for such altered documentation. Information of third parties may be subject to additional restrictions.

Resale of TI components or services with statements different from or beyond the parameters stated by TI for that component or service voids all express and any implied warranties for the associated TI component or service and is an unfair and deceptive business practice. TI is not responsible or liable for any such statements.

Buyer acknowledges and agrees that it is solely responsible for compliance with all legal, regulatory and safety-related requirements concerning its products, and any use of TI components in its applications, notwithstanding any applications-related information or support that may be provided by TI. Buyer represents and agrees that it has all the necessary expertise to create and implement safeguards which anticipate dangerous consequences of failures, monitor failures and their consequences, lessen the likelihood of failures that might cause harm and take appropriate remedial actions. Buyer will fully indemnify TI and its representatives against any damages arising out of the use of any TI components in safety-critical applications.

In some cases, TI components may be promoted specifically to facilitate safety-related applications. With such components, TI's goal is to help enable customers to design and create their own end-product solutions that meet applicable functional safety standards and requirements. Nonetheless, such components are subject to these terms.

No TI components are authorized for use in FDA Class III (or similar life-critical medical equipment) unless authorized officers of the parties have executed a special agreement specifically governing such use.

Only those TI components which TI has specifically designated as military grade or "enhanced plastic" are designed and intended for use in military/aerospace applications or environments. Buyer acknowledges and agrees that any military or aerospace use of TI components which have **not** been so designated is solely at the Buyer's risk, and that Buyer is solely responsible for compliance with all legal and regulatory requirements in connection with such use.

TI has specifically designated certain components as meeting ISO/TS16949 requirements, mainly for automotive use. In any case of use of non-designated products, TI will not be responsible for any failure to meet ISO/TS16949.

Products

Audio	www.ti.com/audio
Amplifiers	amplifier.ti.com
Data Converters	dataconverter.ti.com
DLP® Products	www.dlp.com
DSP	dsp.ti.com
Clocks and Timers	www.ti.com/clocks
Interface	interface.ti.com
Logic	logic.ti.com
Power Mgmt	power.ti.com
Microcontrollers	microcontroller.ti.com
RFID	www.ti-rfid.com
OMAP Applications Processors	www.ti.com/omap
Wireless Connectivity	www.ti.com/wirelessconnectivity

Applications

Automotive and Transportation	www.ti.com/automotive
Communications and Telecom	www.ti.com/communications
Computers and Peripherals	www.ti.com/computers
Consumer Electronics	www.ti.com/consumer-apps
Energy and Lighting	www.ti.com/energy
Industrial	www.ti.com/industrial
Medical	www.ti.com/medical
Security	www.ti.com/security
Space, Avionics and Defense	www.ti.com/space-avionics-defense
Video and Imaging	www.ti.com/video

TI E2E Community

e2e.ti.com