

## HIGH VOLTAGE POWER SUPPLY AND DIVIDER ASSEMBLY FOR STANDARD 1 1/8 INCH SIDE-ON PHOTOMULTIPLIER TUBES

### FEATURES:

- SMALL SIZE
- LOW POWER CONSUMPTION
- LINEAR RANGE GREATLY EXTENDED
- NO EXPOSED HIGH VOLTAGE WIRING
- COMPETITIVELY PRICED

### APPLICATIONS:

- FOR STANDARD 1 1/8 INCH SIDE-ON PHOTOMULTIPLIER TUBES
- BATTERY-POWERED, PORTABLE INSTRUMENTS
- SIZE REDUCTION

### PRODUCT HIGHLIGHTS:

- 300 TO 1100 VOLT OPERATING RANGE
- LESS THAN 7 mA. IDLE CURRENT
- SIGNAL CURRENT LINEARITY OF 0.5% AT 100 UAMP (HC123-01)
- LOW TEMPERATURE DRIFT: 100 PPM PER °C (HC123-01)



### PRODUCT DESCRIPTION:

The HC122-01 and HC123-01 are compact, high voltage power modules that include the necessary voltage divider and mating socket for all standard 1 1/8th inch side window photomultiplier tubes. These modules are new in that they use the Cockcroft-Walton voltage multiplier to generate the high voltage, as well as to perform the voltage division normally accomplished with a resistive divider. The design is implemented with surface mount components and is potted to guard against moisture and contamination. Several performance advantages are obtained: lower operating current, improved linearity at higher output signal levels, and smaller size.

For the HC122-01, the high voltage is set by adjustment of the low voltage input. The output is proportional to the input. For the HC123-01, the high voltage is regulated and can be controlled by either resistance or voltage programming.

**CIRCUIT DESCRIPTION:** A self-oscillating circuit is used to convert DC power to a 185 kHz sine wave of 100 volts peak-to-peak. As shown in Figure 1, this voltage is applied

to a 10 stage Cockcroft-Walton voltage multiplier, resulting in the generation of -1000 volts in 10 precisely divided, 100 volt steps. The actual operating voltage can be adjusted by varying the voltage applied to the oscillator input. The adjustment ranges over -300 to -1100 volts. For the HC122-01, control of the operating voltage is achieved by setting the input voltage by a high-stability voltage source with low output impedance (10 ohms or less) and moderate current capability (20 mA.). Figure 3 shows the relation between input voltage and the operating high voltage for the HC122-01.

The HC123-01 uses the above-mentioned power oscillator and voltage multiplier but adds a feedback regulating circuit to better control the output voltage. As shown in Figure 2, a precision divider reduces the negative high voltage by a thousand times. This voltage is then added to an externally generated, positive control voltage to effect a null. The null signal is then amplified and used to control the voltage applied to the power oscillator through a pass transistor. Thus, the output voltage is set and regulated to a high accuracy by a low voltage input.

# SPECIFICATIONS

## MAXIMUM RATINGS<sup>1</sup>

	HC122-01	HC123-01	UNITS
HV output voltage	- 1100	- 1100	volts
Supply voltage	+ 8	+ 18	volts
Operating temperature	+ 5 to + 50	+ 5 to + 50	°C
Storage temperature	- 20 to + 70	- 20 to + 70	°C

## GENERAL SPECIFICATIONS

HV output voltage range <sup>2</sup>	- 300 to - 1100	- 300 to - 1100	volts
Supply voltage range	0 to + 8	+ 11.5 to 15.5	volts
HV output/input ratio	140 to 1	1000 to 1	volt/volt
Voltage divider ratio	1/10 of high voltage per stage		volt/volt
Warm-up time	10		minutes
HV output voltage decay time constant	10		seconds
Weight (approximate)	65		grams

## PERFORMANCE SPECIFICATIONS (at 25 °C, - 1000 volts)

Power consumption <sup>3</sup>	7		mA.
Temperature coefficient of output voltage <sup>4</sup> (20 °C to 45 °C)			
Typical	.03	.005	% per °C
Maximum	.06	.01	% per °C
Anode ripple interference (maximum) <sup>5</sup>	1		millivolt
Linearity of anode output signal current (typical) <sup>6</sup>	2.0 (10 uA.)	0.5 (100 uA.)	%
Input regulation (per volt change of input)	n.a.	.005	%
Input current limit (typical)	none	20	mA.

## NOTES

- 1) Stresses above the "Maximum Ratings" may cause permanent damage to the device. Exposure to maximum conditions for extended periods may reduce device reliability.
- 2) Measurement of the high voltage (at the photocathode) using ordinary test meters is not recommended since too much loading of the power supply occurs. Depending upon the required accuracy, use one of the following techniques:
  - a.) Measure the input voltage and multiply by 140 for the HC122-01 to get a typical accuracy of 25 volts at the photocathode. For the HC123-01, measure the voltage at the programming input and multiply by 1000 for an accuracy of 5 volts typical at the photocathode.
  - b.) For measurement accuracy within a few volts, measure the D9 voltage and multiply by 10. Interstage voltage can be checked by testing D9 minus D8, D8 minus D7, etc.
  - c.) Use a high voltage probe having an input resistance of at least 1000 megohms.
- 3) Current consumption increases if high light levels are applied to the photomultiplier tube.
- 4) This is an average measurement. The maximum voltage is subtracted from the minimum voltage over the specified temperature range and divided by the temperature difference. The internal reference is used with an external, 10 kohm potentiometer.
- 5) Measured with the 18 inch coax signal lead connected to an unterminated scope input having 20 pF capacitance and 1 megohm resistance. For lower load resistance or more capacitance (that is, lower gain and bandwidth), the ripple becomes proportionally less.
- 6) This measurement is for DC light input. Short pulses (50 microséc. or less) will show good linearity to milliamp current levels. Tube characteristics such as gain drop or hysteresis may cause additional inaccuracies when measuring high light levels at high signal current levels.

The relationship between this input voltage and the high voltage output is shown in Figure 3. This input can be supplied by another power supply, the DAC output of a computer, or from the internal reference built into the HC123-01.

Due to the feedback regulation, the HC123-01 provides the best characteristics for long term stability, temperature stability and linearity of the output signal in comparison to the HC122-01. By using the internal reference and an external set potentiometer, good results are achieved with less concern for the stability of the power source. The HC122-01 should be used where cost is an over-riding concern.

**RIPPLE NOISE:** Stray capacitance may couple an interfering noise on the signal lead from the 185 kHz power oscillator. Under the test conditions of 1 Megohm gain, 70 pF capacitive load (50 pF from the coax and 20 pF from the scope) and a bandwidth of 2 kHz, the interference is less than 1 millivolt p-p. For slowly changing signals, this interference should pose no problem. For wider bandwidth, the load resistance should be reduced to make the PMT generate more of the gain (being careful not to exceed

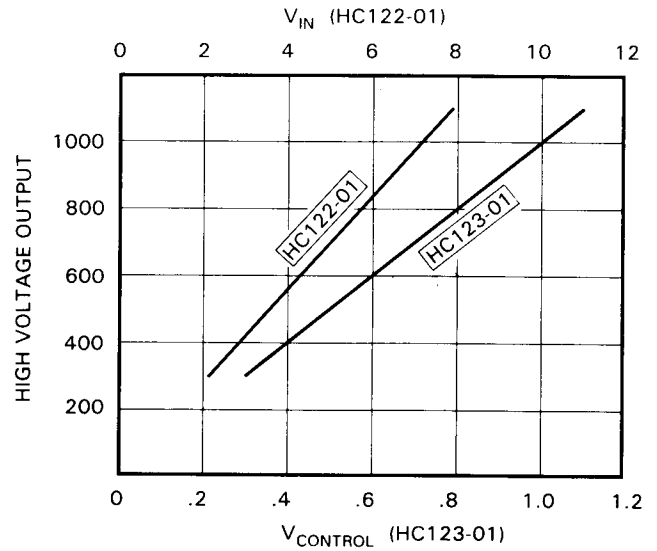

Figure 3. High voltage output vs. input

the average current handling limits of the PMT being used). For lowest noise, the magnetic shield around the PMT should be well-grounded.

**LINEARITY:** Since the voltage division is not achieved by a resistive divider, the output impedance seen by the dynodes of the PMT is lower in these new supplies. And as the light level is increased and current flow increases, the dynode voltage shows significantly less variation. The result is a much more linear response of the PMT to a wider range of light as shown in Figure 4. Note also that, due to the feedback regulation, the HC123-01 provides the best

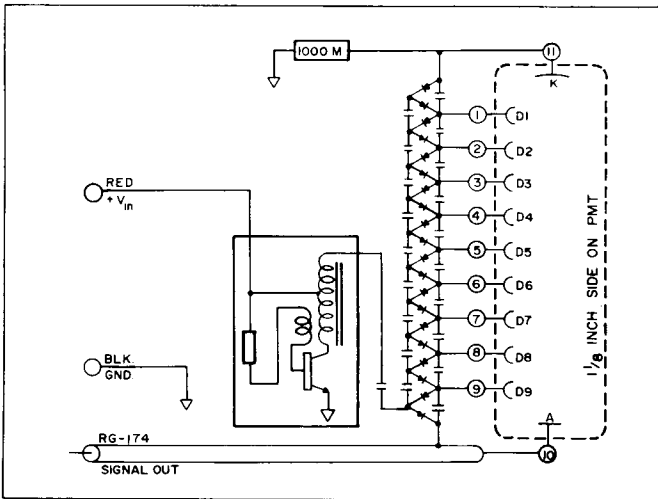

Figure 1. HC122-01 schematic diagram

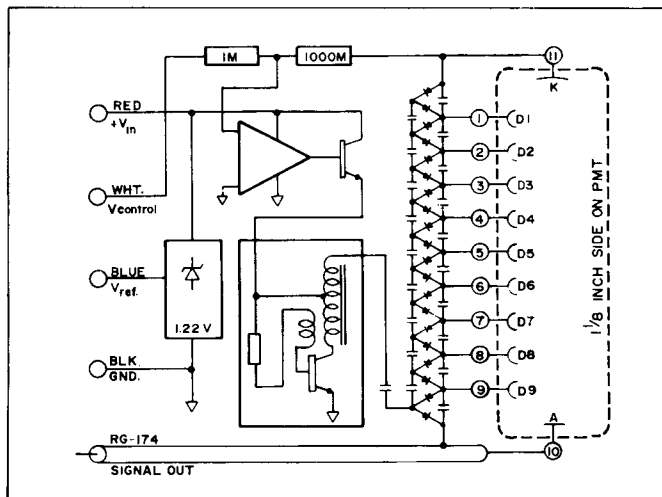

Figure 2. HC123-01 schematic diagram

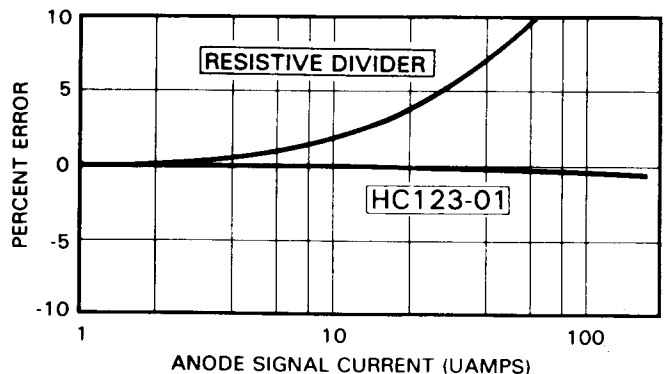
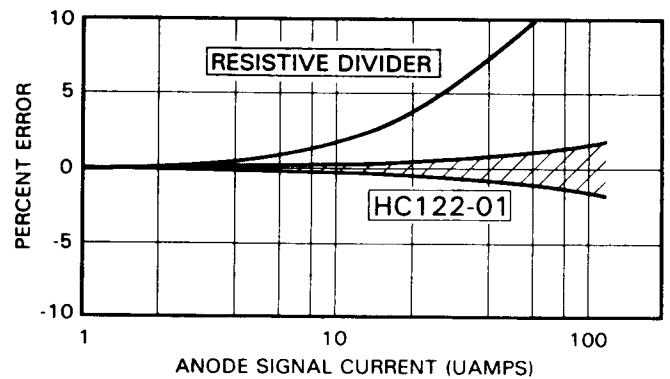
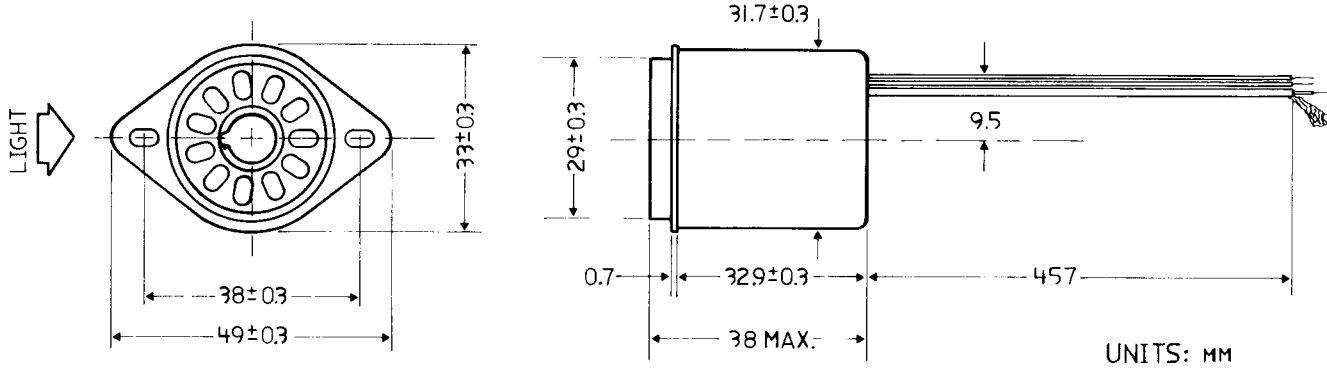

Figure 4. DC linearity

# HC122-01, HC123-01 HV Supplies

## DIMENSIONAL OUTLINE



response. This test was based upon light pulses of several seconds duration – long enough to let the feedback loop stabilize, but short enough to limit gain drop of the PMT.

**CURRENT LIMIT:** The low output impedance brings a disadvantage in that there is no safe limit to the light induced current flow. For the HC122-01, a PMT exposed to room light will sustain an anode current of several milliamps and will draw more than 100 milliamps from the supply. Although no harm will come to the power supply, the PMT will be ruined in short order. It is best to incorporate some form of current limit in the low voltage supply for the HC122-01. Such a current limit is built into the HC123-01. Primary side current limits at 20 milliamps or a few hundred microamps anode current.

**RELIABILITY:** All units receive a 100 hour burn-in at 60°C and operating at 1800 volts to isolate weak components. In applying these supplies, the maximum ratings should be strictly observed since exceeding the ratings for extended periods of time may reduce device reliability. Consult the factory for life expectancy information, which is being measured at this time.

For applications assistance call: 1-800-524-0504

For sales information call: 1-908-231-0960

## WIRING EXAMPLES

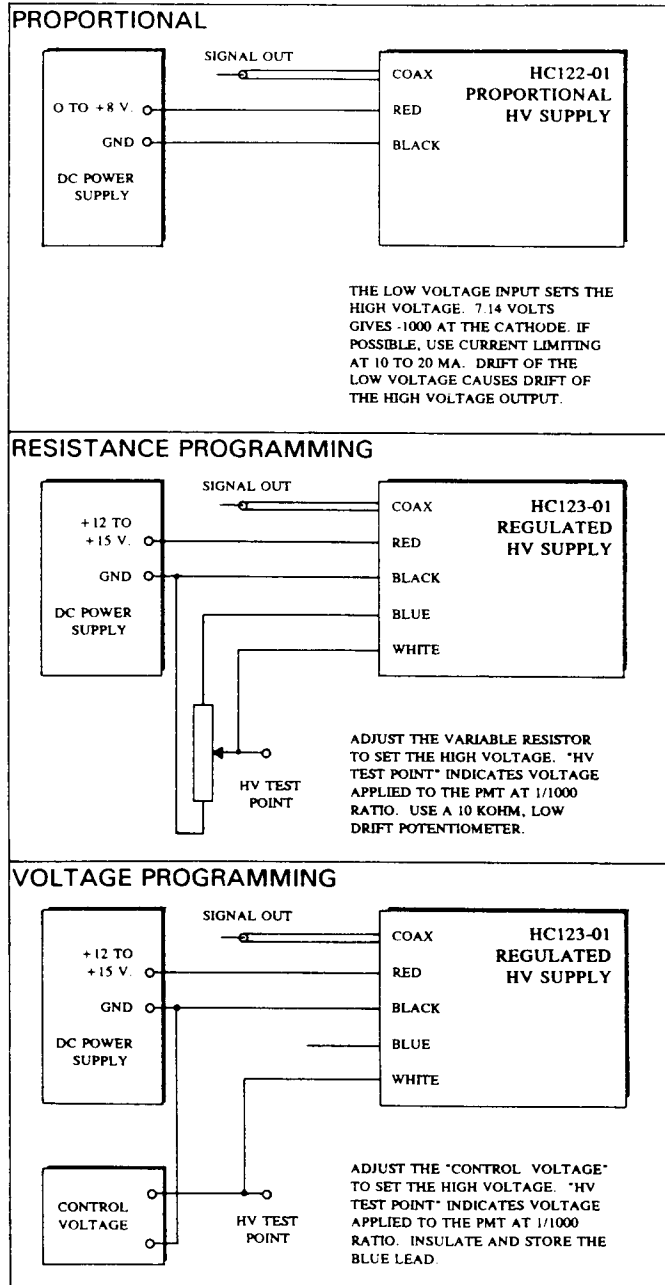

# HAMAMATSU