

# Infrared LED

## L2791 series

Small emission spot LED using current confined chip

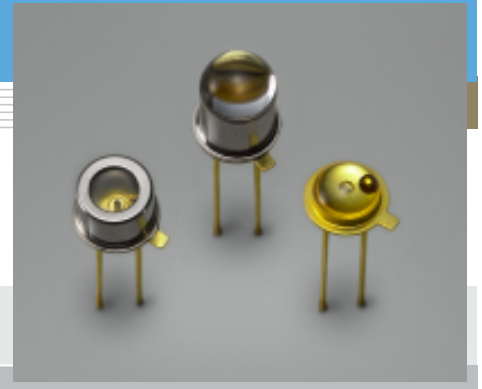

L2791 is infrared LED with a microball lens cemented to the current confined chip surface. This combination ensures high directivity and improved emission uniformity. In particular, L2791-02 uses a lens cap that delivers even narrower directivity. As a variant type not using a microball lens, L2791-03 is also available with the LED chip potted with resin, which gives a small emission spot of  $\phi 160 \mu\text{m}$ .

### Features

- Small emission spot  
L2791 :  $\phi 400 \mu\text{m}$   
L2791-03:  $\phi 160 \mu\text{m}$
- Uniform emission: L2791/-02
- Narrow directivity: L2791/-02

### Applications

- Automatic control systems
- Optical switches
- Auto-focus

### ■ Absolute maximum ratings (Ta=25 °C)

Parameter	Symbol	Condition	Value	Unit
Forward current	IF		80	mA
Reverse voltage	VR		3	V
Pulse forward current	IFP	Pulse width=10 $\mu\text{s}$ Duty ratio=1 %	0.5	A
Operating temperature	Topr		-30 to +85	°C
Storage temperature	Tstg		-40 to +100 *	°C

\* L2791-03 is guaranteed to resist temperature cycle test of up to 5 cycles.

### ■ Electrical and optical characteristics (Ta=25 °C)

Parameter	Symbol	Condition	L2791			L2791-02			L2791-03			Unit
			Min.	Typ.	Max.	Min.	Typ.	Max.	Min.	Typ.	Max.	
Peak emission wavelength	$\lambda_p$	IF=50 mA	850	880	910	850	880	910	850	880	910	nm
Spectral half width	$\Delta\lambda$	IF=50 mA	-	60	-	-	60	-	-	60	-	nm
Forward voltage	VF	IF=50 mA	-	1.5	1.7	-	1.5	1.7	-	1.5	1.7	V
Pulse forward voltage	VFP	IF=0.5 A	-	3.2	4.0	-	3.2	4.0	-	3.2	4.0	V
Reverse current	IR	VR=3 V	-	-	10	-	-	10	-	-	10	$\mu\text{A}$
Radiant flux	$\phi_e$	IF=50 mA	1.6	2.0	-	1.6	2.0	-	4.0	5.0	-	mW
Radiant illuminance	PE	IF=50 mA	-	1.3	-	-	2.0	-	-	-	-	$\text{mW}/\text{cm}^2$
Rise time	tr	IF=50 mA, 10 to 90 %	-	0.12	0.2	-	0.12	0.2	-	0.12	0.2	$\mu\text{s}$
Fall time	tf	IF=50 mA, 90 to 10 %	-	0.12	0.2	-	0.12	0.2	-	0.12	0.2	$\mu\text{s}$

## ■ Emission spectrum

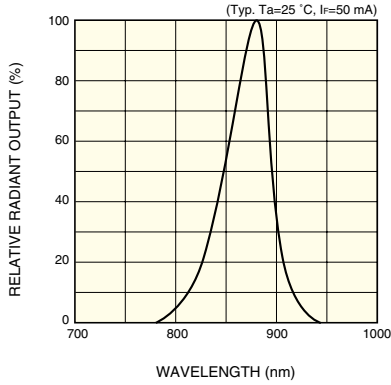

KLEDB0158EA

## ■ Radiant flux vs. forward current

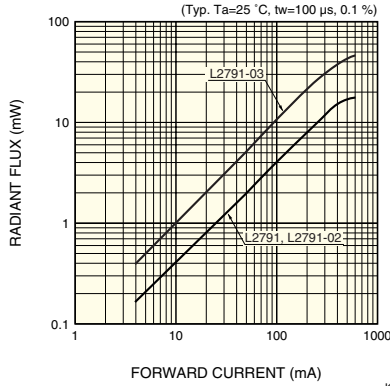

KLEDB0159EA

## ■ Forward current vs. forward voltage

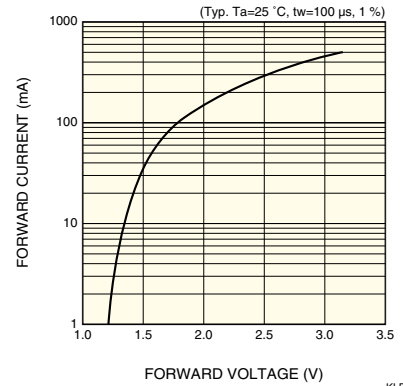

KLEDB0160EA

## ■ Directivity

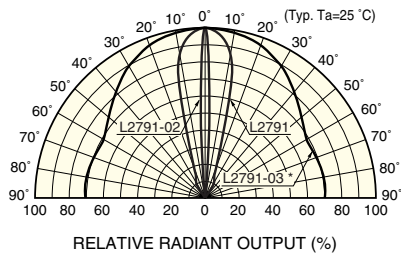

\* L2791-03: Except for reflection ingredient of the base.

KLEDB0161EA

## ■ Radiant output vs. ambient temperature

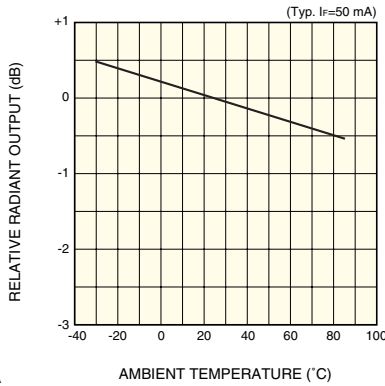

KLEDB0162EA

## ■ Allowable forward current vs. ambient temperature

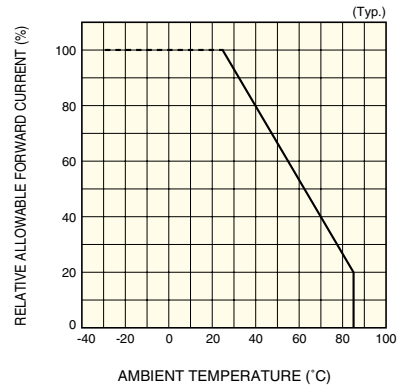

KLEDB0027EB

## ■ Dimensional outlines (unit: mm)

### ① L2791

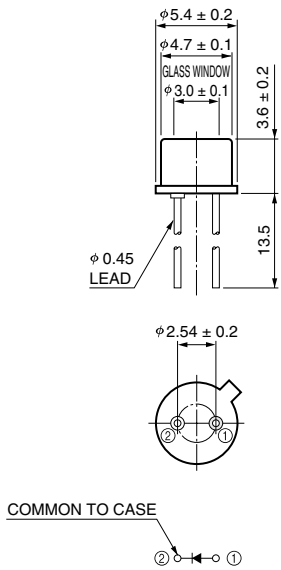

KLEDA0060EA

### ② L2791-02

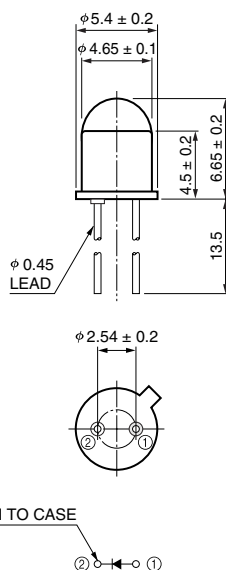

KLEDA0059EA

### ③ L2791-03

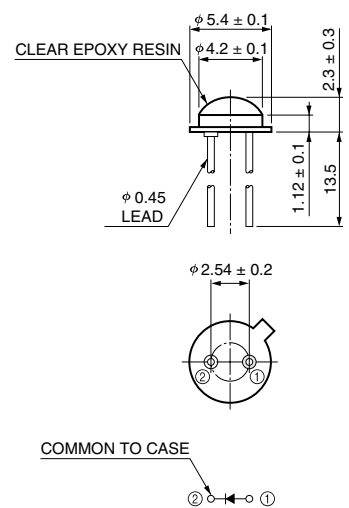

KLEDA0058EA

# HAMAMATSU

HAMAMATSU PHOTONICS K.K., Solid State Division

1126-1 Ichino-cho, Hamamatsu City, 435-8558 Japan, Telephone: (81) 053-434-3311, Fax: (81) 053-434-5184, <http://www.hamamatsu.com>

U.S.A.: Hamamatsu Corporation: 360 Foothill Road, P.O.Box 6910, Bridgewater, N.J. 08807-0910, U.S.A., Telephone: (1) 908-231-0960, Fax: (1) 908-231-1218

Germany: Hamamatsu Photonics Deutschland GmbH: Arzbergerstr. 10, D-82211 Herrsching am Ammersee, Germany, Telephone: (49) 08152-3750, Fax: (49) 08152-2658

France: Hamamatsu Photonics France S.A.R.L.: 8, Rue du Saule Trapu, Parc du Moulin de Massy, 91882 Massy Cedex, France, Telephone: 33-(1) 69 53 71 00, Fax: 33-(1) 69 53 71 10

United Kingdom: Hamamatsu Photonics UK Limited: 2 Howard Court, 10 Twin Road, Welwyn Garden City, Hertfordshire AL7 1BW, United Kingdom, Telephone: (44) 1707-294888, Fax: (44) 1707-325777

North Europe: Hamamatsu Photonics Norden AB: Smidesvägen 12, SE-171 41 Solna, Sweden, Telephone: (46) 8-509-031-00, Fax: (46) 8-509-031-01

Italy: Hamamatsu Photonics Italia S.R.L.: Strada della Moia, 1/E, 20020 Arese, (Milano), Italy, Telephone: (39) 02-935-81-733, Fax: (39) 02-935-81-741

Information furnished by HAMAMATSU is believed to be reliable. However, no responsibility is assumed for possible inaccuracies or omissions. Specifications are subject to change without notice. No patent rights are granted to any of the circuits described herein. ©2001 Hamamatsu Photonics K.K.