



Table of Contents

Safety Information	3	Special Applications	
Fluid Compatibility	4	FD17 Series	109
Safeline Operation Guidelines	145	FD69 Series	110
Fluid Transfer and Hydraulic		FD83 Series	112
HK ISO 7241/1B Series Interchange	8	2HKIG/2HKIL Series	113
H15000 Series ISO 7241-1 A Interchange	17	ST Series	116
5600 ISO 7241-1 A Series Interchange	19	L7000 Series	120
IA Series ISO 7241-1 A Interchange	21	R4000 Series	129
H5000 Series	24	Diagnostic	
FF Series	33	FD15 Series	135
MLFF Series	38	FD90 Series	137
FFCup Series	40	Agriculture	
FD96 Series	42	K8000 Series	139
MLDB Series	44	Q9000 Series	140
ADB Series	46	Refrigerant	
5100 Series	48	5400 Series	141
FD85 Series	52	Part Number Index	146
FD86 Series	54		
W46000 Series	56		
W36000 Series	57		
GA90090 Series	61		
W6000 Series	62		
HP3 Series	68		
WA56000 Series	69		
FD35 Series	70		
Pneumatic			
Safeline Series	73		
1000 Series	84		
G600 Series	88		
G700 Series	91		
I900 Series	93		
I1000 Series	95		
T1100 Series	97		
T1300 Series	99		
Blow Guns	101		
Adapters	102		
Hose Reels	108		

Eaton Quick Disconnect Couplings – Customizing Solutions for the Future... Hydraulics and Beyond

For over 90 years, Eaton has continued to manufacture and supply the highest performing quick disconnect couplings globally for customers serving many industries including agriculture, construction, transportation, and fire and rescue just to name a few. Eaton's quality and performance are never compromised when it comes to engineering and manufacturing its full line of quick disconnect couplings. From traditional industry standards to custom couplings for the next generation of emerging markets and new advanced technologies, Eaton continues to provide quick disconnect coupling solutions to meet your demands.

Custom Design Capability – One Application at a Time

Eaton continues the tradition of developing custom quick disconnect couplings for customers who need a product to perform above and beyond industry standards. Whether it is a custom coupling for the world's most powerful and sophisticated super computers that use electronic cooling or a self-contained breathing apparatus coupling for first responders, Eaton has the ability to work directly with you on a solution. Contact Eaton to see how our dedicated and experienced design engineering team will work with you to develop a quick disconnect coupling solution.

Safety Information for Eaton Quick Disconnect Couplings

1.0 General Instructions.

1.1 Scope. The scope of this safety bulletin is to warn against improper selection, use, installation, etc. of Eaton coupling products.

1.2 Distribution. A copy of this safety bulletin should be distributed to all individuals responsible for using and/or selecting Eaton coupling products.

1.3 Fail-Safe. Design all systems and equipment for fail-safe operation such that failure of any component does not result in personal injury and/or property damage.

1.4 User Responsibility. It is the sole responsibility of the user to select and determine that the Eaton product is compatible with the end use application. The user is responsible for reading and following this safety bulletin as well as any instructions or literature on the Eaton product being used. The user must provide necessary product warnings for Eaton couplings products, used with systems or equipment, to the operators of the systems or equipment.

1.5 Usage with other Manufacturers' Products. When using Eaton coupling products with other manufacturers' adapters, hoses, etc., do not exceed the lowest pressure rating of any of the components being used or rupture may result.

2.0 Selection of Eaton Couplings.

2.1 Pressure. Ensure that the maximum operating pressure of the system or equipment does not exceed the rated operating pressure of the Eaton coupling product or rupture may result.

2.2 Fluid Compatibility. Verify that all components (seals, metals, etc.) are compatible with the fluid being conveyed. Failure to do so may result in high speed fluid discharge and/or leakage of fluids which may be flammable, toxic, at extreme temperatures, or otherwise harmful.

2.3 Temperature. Ensure that the maximum operating temperature of the system or equipment does not exceed the rated operating temperature of the Eaton coupling product (including seals) or rupture may result.

2.4 Coupling Size. Use properly sized couplings such that there is not a large pressure drop across them thus avoiding system damage due to excessive heat generation or failure of internal components.

2.5 Sleeve Lock. Use sleeve locks or threaded couplings where there is the possibility of accidental disconnection. Failure to utilize sleeve locks or threaded couplings in these applications may result in hose whip, expelled components, high speed fluid discharge, system damage, or leakage of fluids which may be flammable, toxic, at extreme temperatures, or otherwise harmful.

2.6 Connect or Disconnect Under Pressure.

If connection and/or disconnection of couplings under pressure is a requirement, only use couplings designed for connection/disconnection under pressure. Failure to utilize this type of coupling in that application may result in hose whip, expelled components, high speed fluid discharge, and/or system damage. Be certain not to confuse the rated operating pressure with the rated connect/disconnect under pressure.

2.7 Environment. Ensure that Eaton couplings are compatible with the surrounding environment. The surrounding environment may be heat, salt water, moisture, chemicals, and the like. Failure to protect against an adverse environment may cause system damage, premature failure, and/or leakage of fluids which may be flammable, toxic, at extreme temperatures, or otherwise harmful.

2.8 External Loads. Avoid any external loads such as side loads, tensile loads, vibration, etc. Failure to do so may result in accidental disconnection, premature failure, system damage, and/or leakage of fluids which may be flammable, toxic, at extreme temperatures, or otherwise harmful.

2.9 Welding & Brazing. Extreme heating of plated products above +450°F (+232°C) such as welding, brazing, baking, etc., where the plating is burned off, may result in the release of deadly gases.

3.0 Installation of Eaton Couplings.

3.1 Inspection of Product. Prior to installation, ensure that the Eaton product meets all of the requirements of the system and/or equipment it is to be used on. Ensure you have the correct part number, function test the coupling by connecting it with a mating half. The function test should result in smooth, non-binding operation or premature failure may result.

3.2 Cleanliness. Use end caps and plugs to reduce the risk of system contamination or damage to critical sealing surfaces. Failure to do so may result in leakage of fluids which may be flammable, toxic, at extreme temperatures, or otherwise harmful. Caps and plugs are not a secondary seal unless explicitly noted.

3.3 Location. Place Eaton couplings in a safe location such as not to expose the user to personal injury (slippage, tripping, falling, etc.) during installation, connection, disconnection and maintenance.

4.0 Product Maintenance. A maintenance schedule should be put in place to ensure that Eaton couplings are functioning properly. Eaton is not responsible for product failures resulting from modification or improper maintenance.

4.1 Inspection. Visually inspect to ensure that there is no leakage, cracked components, corrosion build-up, contamination build-up, wear, etc. If any abnormality is encountered, the coupling should be replaced immediately.

Fluid Compatibility

This chart indicates the suitability of various elastomers and metals for use with fluids to be conveyed. It is intended for use with Eaton couplings and should not be used to determine compatibility for other products. It is intended as a guide only and is not a guarantee. Final selection of the proper seal or material of metal components is further dependent on many factors including pressure, fluid and ambient temperature, concentration, duration of exposure, etc.

How to Use the Chart

- Both the elastomer and the metal must be considered when determining suitability of combination for a coupling.
- Locate the fluid to be conveyed and determine the suitability of the elastomeric and metal components according to the resistance rating shown for each.
- Dimensional and operation specifications for each coupling can be found on the catalog pages.
- Information on seal options for couplings, and how to specify them, are shown in the respective sections of this catalog.
- Be sure to check the table below for maximum operating temperature range of the elastomer desired.
- For further details on the products shown in this catalog, and their applications, consult your Eaton Sales Representative or Eaton Technical Support.
- Coupling component materials may differ from body material. Refer to specific catalog pages.

Resistance Rating Key

- E = Excellent – Fluid has little or no effect
- G = Good – Fluid has minor to moderate effect
- C = Conditional – Service conditions should be described to Eaton for determination of suitability for application
- U = Unsatisfactory

The differences between ratings “E” and “G” are relative. Both indicate satisfactory service. Where there is a choice, the materials rated “E” may be expected to give better or longer service than those rated “G”.

The charts below are intended for reference use only. The information in this chart pertains strictly to material compatibility and is not intended to be used as an application guide.

E=Excellent
G=Good
C=Conditional
U=Unsatisfactory

Fluid	Seals				Metal			
	Buna-N	Neoprene	FPDM/EPDM	FKM	Steel	Brass	Stainless Steel	Aluminum
Acetaldehyde	U	C	C	U	G	E	E	E
Acetic Acid, 10%	U	U	E	G	U	U	C	C
Acetic Acid, Glacial	U	U	C	U	U	U	C	C
Acetone	U	U	G	U	E	E	E	E
Acetophenone	U	U	E	U	E	E	E	C
Acetyl Acetone	U	U	G	U	U	C	C	C
Acetyl Chloride	U	U	U	E	C	C	C	U
Acetylene (1)	G	U	G	E	E	E	E	E
Air, Hot (Up to +160°F)	E	E	E	E	E	E	E	E
Air, Hot (161°F – 200°F)	C	G	E	E	E	E	E	E
Air, Hot (201°F – 300°F)	U	U	G	E	E	E	E	E
Air Wet, below 160°F	E	E	E	E	U	G	E	E
Aluminum Chloride, 10% aq	E	E	E	E	U	U	U	U
Aluminum Fluoride, 10% aq	E	E	E	E	U	U	U	E
Aluminum Nitrate, 10% aq	E	E	E	E	U	U	C	C

Fluid	Seals				Metal			
	Buna-N	Neoprene	FPDM/EPDM	FKM	Steel	Brass	Stainless Steel	Aluminum
Aluminum Sulfate, 10% aq	E	E	E	E	U	C	E	C
Alums, 10% aq	E	E	E	E	U	C	E	C
Ammonia, Cold	E	E	E	U	E	U	E	E
Ammonia, Hot	U	G	G	U	E	U	E	E
Ammonia, Anhydrous	G	G	E	U	E	U	E	E
Ammonia, Aqueous	E	E	E	U	E	U	E	E
Ammonium Carbonate, 10% aq	U	E	E	U	C	U	C	C
Ammonium Chloride, 10% aq	E	E	E	U	U	U	C	U
Ammonium Hydroxide, 10% aq	C	C	E	C	G	U	C	C
Ammonium Nitrate, 10% aq	E	G	E	U	G	U	G	G
Ammonium Phosphate, 10% aq	E	E	E	-	U	C	G	U
Ammonium Sulfate/Sulfide, 10% aq	E	E	E	U	U	U	G	U
Amyl Acetate	U	U	G	U	E	E	E	E
Amyl Alcohol	G	C	E	G	G	G	E	U
Aniline, Aniline Oil	U	U	G	U	E	U	E	G

Fluid Compatibility

E=Excellent
G=Good
C=Conditional
U=Unsatisfactory

Fluid	Seals				Metal			
	Buna-N	Neoprene	FPDM/EPDM	FKM	Steel	Brass	Stainless Steel	Aluminum
Aniline Dyes	U	G	G	G	U	C	G	C
Asphalt, < 200°F	G	C	U	E	E	G	E	C
IRM 901 Oil	E	E	C	E	E	E	E	E
IRM 902 Oil	E	G	U	E	E	E	E	E
IRM 903 Oil	E	C	U	E	E	E	E	E
Automatic Trans. Fluid	E	C	U	E	E	E	E	E
Barium Chloride, 10% aq	E	E	E	E	U	G	G	G
Barium Hydroxide, 10% aq	E	E	E	E	G	U	G	U
Barium Sulfide, 10% aq	E	E	E	E	C	U	G	U
Benzene, Benzol	U	U	U	E	G	E	E	G
Benzoic Acid	U	U	U	E	U	G	G	G
Benzyl Alcohol	U	G	G	E	E	G	E	G
BioDiesel (<B20)	G	C	U	E				
BioDiesel (>B20)	G	C	U	E				
Black Sulfate Liquor	C	C	C	E	E	C	E	U
Blast Furnace Gas	U	U	U	E	E	C	E	U
Borax, 10% aq	G	G	E	E	E	E	E	G
Boric Acid, 10% aq	G	G	G	E	U	G	C	C
Brine	E	G	E	E	U	G	G	U
Bromine, Dry	U	U	U	E	U	C	U	C
Butane	E	C	U	E	E	E	E	E
Butyl Acetate	U	U	G	U	E	E	E	E
Butyl Alcohol	E	E	G	E	G	G	G	G
Butyl Cellosolve	U	U	G	U	E	E	E	E
Butylene (Butene)	C	U	U	E	E	E	E	E
Butyl Stearate	G	U	U	E	G	G	G	G
Butyraldehyde	U	U	G	U	E	E	E	E
Calcium Acetate, 10% aq	G	G	E	U	G	G	G	C
Calcium Bisulfate, 10% aq	E	E	U	E	U	C	C	U
Calcium Chloride, 10% aq	E	E	E	E	G	G	G	C
Calcium Hydroxide, 10% aq	E	E	E	E	G	G	G	U
Calcium Hypochlorite, 10% aq	U	U	E	E	U	G	C	U
Calcium Nitrate, 10% aq	E	E	E	E	G	G	G	G
Carbitol	G	G	G	G	E	E	E	E
Carbolic Acid (Phenol)	U	U	G	E	U	E	E	-
Carbonic Acid	G	E	E	E	U	C	E	G
Carbon Dioxide, Dry Gas	G	G	E	E	E	E	E	E
Carbon Disulfide	U	U	U	E	G	G	G	E
Carbon Monoxide	G	G	E	E	E	E	E	E
Carbon Tetrachloride	U	U	U	E	U	G	G	U
Castor Oil	E	E	G	E	E	E	E	E
Cellosolve Acetate	U	U	G	U	U	U	E	G
China Wood Oil (Tung Oil)	G	G	U	E	E	G	E	E
Chlorine Gas, Dry	U	U	U	G	C	C	C	C
Chloroacetic Acid	U	U	G	U	U	U	U	U
Chloroacetone	U	U	E	U	G	G	G	U
Chlorobenzene	U	U	U	G	G	G	G	G
Chloroform	U	U	U	E	G	G	G	G
O-Chlorophenol	U	U	U	E	G	G	G	U
Chlousulfonic Acid	U	U	U	U	G	U	G	G
Chrome Plating Solution	U	U	G	E	C	U	U	U

Fluid	Seals				Metal			
	Buna-N	Neoprene	FPDM/EPDM	FKM	Steel	Brass	Stainless Steel	Aluminum
Chromic Acid	U	U	C	E	C	U	U	U
Citric Acid	E	E	E	E	C	C	C	C
Coke Oven Gas	U	U	U	E	E	C	E	U
Copper Chloride, 10% aq	E	E	E	E	U	U	U	U
Copper Cyanide, 10% aq	E	E	E	E	E	U	G	U
Copper Sulfate, 10% aq	E	E	E	E	U	C	G	U
Cotton Seed Oil	E	G	C	E	E	E	E	E
Creosote (Coal Tar)	G	C	U	E	E	C	E	E
Crude Oil	E	G	U	E	G	U	G	U
Cyclohexanol	E	G	U	E	E	E	E	C
Cyclohexanone	U	U	G	U	E	E	E	C
Detergent/Water Solution	E	E	E	E	G	E	E	E
Diacetone Alcohol (Acetol)	U	U	E	U	E	E	E	E
Dibenzyl Ether	U	U	G	U	G	G	G	G
Diesel Oil	E	C	U	E	E	E	E	E
Diethylamine	G	G	G	U	E	U	E	-
Diocetyl Phthalate (DOP)	U	U	G	G	E	E	E	E
DOT #3 / #4 Brake fluid	C	U	E	U	E	C	E	E
Dowtherm A&E	U	U	U	E	G	U	E	E
Ethyl Alcohol (Ethanol)	E	E	E	E	E	E	E	G
Ethyl Acetate	U	U	G	U	E	E	E	E
Ethyl Benzene	U	U	U	E	E	G	G	G
Ethyl Cellulose	G	G	G	U	E	G	G	G
Ethyl Chloride	U	U	U	E	E	E	E	G
Ethylene Dichloride	U	U	U	G	G	C	G	G
Ethylene Glycol	E	E	E	E	U	G	E	E
Ferric Chloride, 10% aq	E	G	E	E	U	U	U	U
Ferric Nitrate, 10% aq	E	E	E	E	U	U	G	U
Ferric Sulfate, 10% aq	G	G	G	E	U	U	E	U
Formaldehyde	C	C	G	G	E	E	E	G
Formic Acid	C	G	E	U	U	C	C	C
Fuel Oil	E	C	U	E	E	E	E	E
Furfural	C	C	G	U	G	G	G	G
Gallic Acid, Solution	G	G	G	E	U	-	G	C
Gasoline	E	U	U	E	E	E	E	E
Gasohol	G	U	U	E	E	E	E	G
Glycerine/Glycerol	E	E	E	E	E	G	E	E
Green Sulfate Liquor	G	G	E	E	U	U	E	U
Helium (1)	E	E	E	E	E	E	E	E
Heptane	E	G	U	E	E	E	E	E
Hexaldehyde	U	G	G	U	G	G	E	E
Hexane	E	G	U	E	E	E	E	E
Hydraulic Oils, petroleum based	G	C	U	E	E	E	E	E
Ester Blend	E	U	U	E	E	E	E	E
Phos. Ester/Petroleum Blend	U	U	U	C	E	E	E	E
Silicone Oils	E	E	E	E	E	E	E	E
Straight Petroleum Base	E	C	U	E	E	E	E	E
Straight Phosphate Ester	U	U	G	C	E	E	E	E
Water Glycol	E	E	E	E	E	E	E	G
Water Petroleum Emulsion	E	G	U	E	C	E	E	G
Hydrobromic Acid	U	U	E	E	E	U	E	E

Fluid Compatibility

E=Excellent
G=Good
C=Conditional
U=Unsatisfactory

Fluid	Seals				Metal			
	Buna-N	Neoprene	FPDM/EPDM	FKM	Steel	Brass	Stainless Steel	Aluminum
Hydrochloric Acid, Cold	U	U	G	E	U	U	U	U
Hydrocyanic Acid	C	C	E	E	E	E	G	E
Hydrofluoric Acid	U	U	C	U	U	U	U	U
Hydrofluorosilic Acid	G	G	E	E	U	U	U	U
Hydrogen	E	E	E	E	E	E	E	E
Hydrogen Peroxide	G	G	G	E	U	U	G	E
Hydrogen Sulfide, Dry	U	G	E	U	E	G	G	G
Isocyanate	U	U	G	E	G	-	G	-
Iso Octane	E	G	U	E	E	E	E	E
Isopropyl Acetate	U	U	G	U	E	-	E	E
Isopropyl Alcohol	G	G	E	E	E	E	E	G
Isopropyl Ether	G	U	U	U	G	G	G	-
JP-4, JP-5	E	U	U	E	E	E	E	E
Kerosene	E	U	U	E	E	E	E	E
Lacquer/Lacquer Solvents	U	U	U	U	U	E	E	E
Lime Sulfur	U	E	E	E	G	U	G	-
Linseed Oil	E	G	U	E	E	E	E	E
LPG	E	G	U	E	E	E	E	E
Magnesium Chloride, 10% aq	E	E	E	E	E	C	C	G
Magnesium Hydroxide, 10% aq	G	G	E	E	E	G	E	G
Magnesium Sulfate, 10% aq	E	E	E	E	E	E	E	E
Maleic Acid	U	U	U	E	E	G	G	G
Maleic Anhydride	U	U	U	E	G	U	E	G
Malic Acid	G	G	U	G	U	-	E	G
Mercuric Chloride	E	E	E	E	U	U	U	U
Mercury	E	E	E	E	E	U	E	U
Methanol	G	G	E	U	G	G	E	C
Methyl Bromide	G	U	U	E	E	E	G	U
Methyl Chloride	U	U	U	E	E	E	E	U
Methyl Butyl Ketone	U	U	E	U	E	E	E	-
Methyl Ethyl Ketone	U	U	E	U	G	G	G	G
Methylene Chloride	U	U	U	G	G	G	G	G
Methyl Isobutyl Ketone	U	U	U	U	G	G	G	G
Methyl Isopropyl Ketone	U	U	U	U	G	G	G	G
Methyl Salicylate	U	U	C	U	E	G	G	E
MIL-L-2104	E	G	U	E	E	E	E	-
MIL-H-5606	E	G	U	E	E	E	E	E
MIL-H-6083	E	E	U	E	E	E	E	-
MIL-L-7808	G	U	U	E	G	G	E	-
MIL-L-23699	G	U	U	E	E	E	E	E
MIL-H-46170	E	G	U	E	E	E	E	-
MIL-H-83282	E	U	U	E	E	E	E	-
Mineral Oils	E	C	U	E	E	E	E	E
Naphtha	C	U	U	E	-	-	-	-
Naphthalene	U	U	U	E	E	G	E	G
Naphthenic Acid	C	U	U	E	-	G	E	G
Natural Gas	E	E	U	E	G	G	G	G
Nickel Acetate, 10% aq	C	C	E	G	G	C	E	G
Nickel Chloride, 10% aq	E	G	E	E	U	U	G	U
Nickel Sulfate, 10% aq	E	E	E	E	U	G	G	U
Nitric Acid, to 10%	U	U	U	E	U	U	E	U

Fluid	Seals				Metal			
	Buna-N	Neoprene	FPDM/EPDM	FKM	Steel	Brass	Stainless Steel	Aluminum
Nitric Acid, over 10%	U	U	U	G	U	U	E	C
Nitrobenzene	U	U	U	G	E	G	E	E
Nitrogen	E	E	E	E	E	E	E	E
Octyl Alcohol	E	E	E	E	E	E	E	E
Oleic Acid	U	U	C	G	C	E	G	C
Oleum, fuming sulfuric acid	U	U	U	E	E	E	E	E
Ortho-Dichlorobenzene	U	U	U	E	G	G	G	G
Oxalic Acid, 10% aq	G	G	E	E	U	C	C	C
Oxygen	-	-	E	E	G	G	G	G
Palmitic Acid	E	G	G	E	G	-	E	G
Para-Dichlorobenzene	U	U	U	E	G	G	G	G
Pentane	E	E	U	E	G	G	G	E
Perchloric Acid	E	G	G	E	U	U	U	U
Perchloroethylene	U	U	U	E	C	G	G	G
Petroleum Base Oils	E	G	U	E	E	E	E	E
Phenol (Carbolic Acid)	U	U	G	E	U	E	E	E
Phosphate Ester	U	U	G	C	E	E	E	E
Phosphoric Acid 20%	U	U	G	E	U	E	U	C
Phosphorous Trichloride	U	U	E	E	C	U	C	E
Potassium Acetate, 10% aq	G	G	E	U	C	G	C	U
Potassium Chloride, 10% aq	E	E	E	E	E	C	E	U
Potassium Cyanide, 10% aq	E	E	E	E	C	U	G	U
Potassium Dichromate, 10% aq	E	E	E	E	C	C	C	C
Potassium Hydroxide, to 10%	G	G	E	G	G	G	G	U
Potassium Hydroxide, over 10%	C	C	E	U	G	G	G	U
Potassium Nitrate, 10% aq	E	E	E	E	G	G	E	G
Potassium Sulfate, 10% aq	E	E	E	E	-	-	-	-
Propane (Liquified)	C	G	-	E	E	E	E	E
Propyl Acetate	U	U	G	U	E	-	E	E
Propyl Alcohol	E	E	E	E	E	E	E	E
Propylene	U	U	U	E	E	E	E	E
Rapeseed oil (B100)	G	C	U	E				
Refrigerant R-12	G	E	C	E	E	E	E	E
Refrigerant R-13	G	E	C	E	E	E	E	E
Refrigerant R-22	U	E	C	U	E	E	E	E
Refrigerant R-134a	E	C	G	U	E	E	E	E
Sewage	E	E	E	E	G	G	G	G
Silicone Oils	E	E	E	E	E	E	E	E
Soap (Water Solutions)	E	E	E	E	E	E	E	U
Sodium Acetate, 10% aq	G	G	E	U	E	E	G	E
Sodium Bicarbonate, 10% aq	E	E	E	E	G	G	E	G
Sodium Borate, 10% aq	E	E	E	E	E	E	E	G
Sodium Carbonate, 10% aq	E	E	E	E	E	G	E	U
Sodium Chloride, 10% aq	E	E	E	E	U	C	C	C
Sodium Cyanide, 10% aq	E	E	E	E	E	-	C	U
Sodium Hydroxide, to 10%	U	G	E	E	C	G	C	U
Sodium Hydroxide, over 10%	U	U	G	E	C	C	C	U
Sodium Hypochlorite, 10% aq	C	C	E	C	U	U	U	U
Sodium Metaphosphate, 10% aq	E	E	E	E	E	G	G	U
Sodium Nitrate, 10% aq	G	G	E	-	E	C	E	E
Sodium Perborate, 10% aq	G	G	E	E	C	U	C	U

Fluid Compatibility

E=Excellent
G=Good
C=Conditional
U=Unsatisfactory

Fluid	Seals				Metal			
	Buna-N	Neoprene	FPDM/EPDM	FKM	Steel	Brass	Stainless Steel	Aluminum
Sodium Peroxide, 10% aq	G	G	E	E	U	U	C	C
Sodium Phosphates, 10% aq	E	E	E	E	U	E	G	U
Sodium Silicate, 10% aq	E	E	E	E	E	E	E	E
Sodium Sulfate, 10% aq	E	E	E	E	C	G	G	G
Sodium Sulfide, 10% aq	E	E	E	E	C	U	C	U
Sodium Thiosulfate, 10% aq	G	E	E	E	U	U	C	G
Soy Bean Oil (B100)	E	C	U	E	E	E	E	E
Stannic Chloride	E	G	E	E	U	U	U	U
Steam (up to 388°F)	U	U	C	C	E	E	E	G
Stearic Acid	G	G	G	E	C	C	E	C
Stoddard Solvent	E	G	U	E	E	E	E	E
Styrene	U	U	U	G	E	E	E	E
Sulfur, Slurry	U	E	E	E	E	U	G	E
Sulfur Chloride, Wet	U	U	U	E	G	–	G	G
Sulfur Dioxide, Dry	U	U	G	E	E	G	G	E
Sulfur Trioxide	U	U	G	E	G	C	G	G
Sulfuric Acid, to 10%	U	G	U	E	U	G	C	–
Sulfuric Acid, over 10%	U	U	U	G	C	C	C	U
Sulfurous Acid	C	C	U	G	U	C	C	C
Tannic Acid	G	E	E	E	E	E	E	C
Tar (Bituminous)	G	U	U	E	E	G	E	E

Fluid	Seals				Metal			
	Buna-N	Neoprene	FPDM/EPDM	FKM	Steel	Brass	Stainless Steel	Aluminum
Tartaric Acid	E	G	G	E	U	C	C	E
Tertiary Butyl Alcohol	G	G	G	E	G	G	G	G
Titanium Tetrachloride	C	U	U	E	E	U	G	U
Toluene (Toluol)	U	U	U	E	E	E	E	E
Trichlorethylene	U	U	U	E	E	G	E	E
Tricresyl Phosphate	U	U	E	G	E	–	C	–
Triethanolamine	E	U	E	U	E	U	E	E
Tung Oil	G	G	U	E	E	G	E	E
Turpentine	G	U	U	E	G	G	G	G
Varnish	G	U	U	E	E	G	E	E
Vinyl Chloride	U	U	U	E	E	U	C	E
Water (to +150°F)	E	E	E	E	C	G	E	G
Water (+151°F to +200°F)	E	E	E	E	C	G	E	G
Water (+201°F to +350°F)	U	U	G	G	C	G	E	G
Water Glycol	E	E	E	E	E	E	E	G
Water Petroleum Emulsion	E	G	U	E	C	E	E	G
Xylene	U	U	U	E	E	E	E	E
Zinc Chloride, 10% aq	E	E	E	E	E	U	U	C
Zinc Sulfate, 10% aq	E	E	E	E	U	C	G	C

Seal Information for Eaton Hansen and Gromelle Products

Dash Number	Compound	Max. Operation temperature range
***	Buna-N – 70 Durometer	-25°C +100°C/-13°F +212°F
-115	PTFE	–
-118	Neoprene	-54°C +100°C/-65°F +212°F
-143	FKM	-29°C +204°C/-15°F +400°F
-146	Buna-N – 70 Durometer	-25°C +100°C/-13°F +212°F
-192*	EPDM – 75 Durometer	-54°C +149°C/-65°F +300°F
-235†	Kalrez® 4079 – 78 Durometer	-20°C +275°C/-4°F +527°F
-236*	EPDM – 90 Durometer	-54°C +149°C/-65°F +300°F
-242	(Kalrez 6375 – 75 Durometer)	-20°C +275°C/-4°F +527°F
-503	(FFKM - 75 Durometer)	-15°C +275°C/+5°F +527°F
-292	(EPDM- 70 Durometer)	-54°C +149°C/-65°F +300°F

***No Dash Number required for standard seal material.

*-192 and -236 compounds are not compatible with mineral-based greases or oils.

†Kalrez seals available by special quotation.

HK Series (Steel) ISO 7241-1 B Interchange



Eaton's HK Series coupling sets the industry standard for ISO B Couplings. The HK Series features a rugged ball latch mechanism with automatic self-sealing poppet valves in a wide array of port configurations and multiple valved and non-valved configurations.

Product Features

- Meets dimensional requirements to ISO standard 7241-1 Series B
- The coupling that sets the industry standard
- Self-sealing poppet valve design provides excellent high and low pressure sealing
- Standard seal material: Buna-N
- Seal options available in PTFE, Neoprene, FKM, EPDM, and Kalrez®
- Standard body material: Zinc trivalent plated steel with stainless steel springs, balls and retaining rings.
- PTFE back up rings in sockets (females)

Physical Characteristics

Series	Body Size (in)	ISO Size (mm)	Nominal Flow Diameter (mm)	Max. Operating Pressure		Max. Operating Pressure		Rated Flow*		Air Inclusion cc. max.	Fluid Loss cc. max.
				Non hazardous liquids & gases Group 2 (bar)	(psi)	Hazardous liquids & gases Group 1 (bar)	(psi)	(lpm)	(gpm)		
1HK	1/8	5	4.4	275	4,000	275	4,000	3	0.8	0.6	0.5
2HK	1/4	6.3	5.9	345	5,000	345	5,000	12	3	1.2	0.9
3HK	3/8	10	7.8	275	4,000	275	4,000	23	6	2.9	2.1
4HK	1/2	12.5	10	345	5,000	345	5,000	45	12	3.6	3.5
6HK	3/4	20	17	275	4,000	275	4,000	100	26	11.5	9.3
8HK	1	25	19.6	275	4,000	275	4,000	189	50	18.0	16.9
10HK	1 1/4**	—	26.7	200	2900	37	537	288	76	48.0	48.0
12HK	1 1/2	40	35.1	150	2175	29	421	375	99	91.3	91.3
20HK	2 1/2	50	46	100	1450	21	305	757	200	209.9	209.9

* For questions related to vacuum please contact Eaton.

** No ISO Standard available for the 10HK

Applications & Markets

- Agriculture
- Hydraulic Tool
- General Industry
- Construction
- Fluid Transfer
- Transportation
- Military
- Law Enforcement/Rescue
- Chemical
- Oil and Gas
- Consumer Products
- HVAC
- Food and Beverage
- Trucks
- Aerospace
- Medical

European Pressure Equipment Directive

Couplings with nominal diameters up to and including 25 mm are designed and manufactured under Article 4.3 of the European Pressure Equipment Directive 2014/68/EU. Couplings with nominal diameters greater than 25 mm are designed and manufactured in accordance with stipulations of Module A of the European Pressure Equipment Directive 2014/68/EU. They should not be used to convey unstable gases.

Group 1 = Hazardous media / Group 2 = Other media

Flow Data

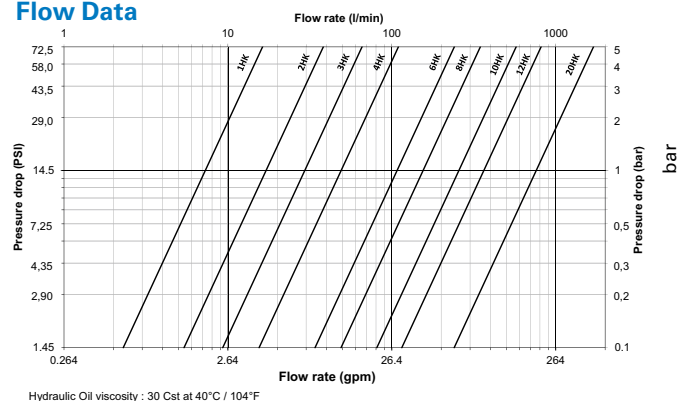

Seal Elastomer Data*

Seal Elastomer**	Max. Operation Temperature Range
Buna-N	-40°C to +121°C/40°F to +250°F
Neoprene	-54°C to +100°C/-65°F to +212°F
EPDM	-54°C to +149°C/-65°F to +300°F
FKM	-29°C to +204°C/-15°F to +400°F

* For reference only, based on Eaton recommended temperatures.

** For seals not listed contact Eaton.

Contact Eaton technical support for further information on fluid compatibility.

HK Series (Steel) ISO 7241-1 B Interchange

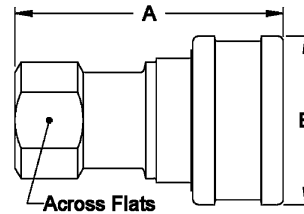

Figure 1

Sockets (Female)

Part Number HK1-8 Series	Body Size (in)	ISO Size (mm)	Thread Size (Female)			Fig.	Dimensions					
			NPTF	BSPP	SAE		A (in)	B (in)	Across Flats (in)	A (mm)	B (mm)	Across Flats (mm)
1H11	1/8	5	1/8-27	-	-	1	1.91	0.98	0.56	48.5	24.9	14.2
1H4	1/8	5	-	-	7/16-20	1	2.06	0.98	0.69	52.3	24.9	17.5
2H16	1/4	6.3	1/4-18	-	-	1	2.26	1.14	0.75	57.4	29.0	19.1
2H16BS	1/4	6.3	-	1/4-19	-	1	2.31	1.14	0.75	58.7	29.0	19.1
2H6	1/4	6.3	-	-	9/16-18	1	2.40	1.14	0.88	61.0	29.0	22.4
3H21	3/8	10	3/8-18	-	-	1	2.56	1.42	0.88	65.0	36.1	22.4
3H21BS	3/8	10	-	3/8-19	-	1	2.56	1.42	0.88	65.0	36.1	22.4
3H8	3/8	10	-	-	3/4-16	1	2.74	1.42	1.00	69.6	36.1	25.4
4HP26	1/2	12.5	1/2-14	-	-	1	2.96	1.86	1.13	75.2	47.2	28.7
4HP26BS	1/2	12.5	-	1/2-14	-	1	2.96	1.86	1.13	75.2	47.2	28.7
4HP10	1/2	12.5	-	-	7/8-14	1	3.05	1.86	1.25	77.5	47.2	31.8
6HP31	3/4	20	3/4-14	-	-	1	3.48	2.22	1.31	88.4	56.4	33.3
6HP31BS	3/4	20	-	3/4-14	-	1	3.48	2.22	1.31	88.4	56.4	33.3
6HP12	3/4	20	-	-	1 1/16-12	1	3.67	2.22	1.38	93.2	56.4	35.1
8HP36	1	25	1-11 1/2	-	-	1	4.13	2.61	1.75	104.9	66.3	44.5
8HP36BS	1	25	-	1-11	-	1	4.13	2.61	1.75	104.9	66.3	44.5
8HP16	1	25	-	-	1 1/16-12	1	4.13	2.61	1.88	104.9	66.3	47.8

A=Overall Length, B=Maximum Diameter

To obtain connected length of coupling, add dimensions A (Fig. 1) and E (Fig. 3) together.

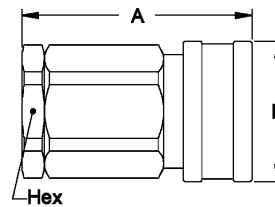

Figure 2

Sockets (Female)

Part Number HK10/12/20 Series	Body Size (in)	ISO Size (mm)	Thread Size (Female)		Fig.	Dimensions					
			NPTF	BSPP		A (in)	B (in)	Hex (in)	A (mm)	B (mm)	Hex (mm)
10H41*	1 1/4	-	1 1/4-11 1/2	-	2	4.51	2.73	2.38	114.6	69.3	60.5
10H41BS*	1 1/4	-	-	1 1/4-11	2	4.51	2.73	2.38	114.6	69.3	60.5
12H41	1 1/2	40	1 1/4-11 1/2	-	2	4.82	3.23	2.38	122.4	82.0	60.5
12H41BS	1 1/2	40	-	1 1/4-11	2	4.82	3.23	2.38	122.4	82.0	60.5
12H46	1 1/2	40	1 1/2-11 1/2	-	2	4.82	3.23	2.38	122.4	82.0	60.5
12H46BS	1 1/2	40	-	1 1/2-11	2	4.82	3.23	2.38	122.4	82.0	60.5
20H51	2 1/2	50	2-11 1/2	-	2	5.55	4.11	3.75	141.0	104.4	95.3
20H51BS	2 1/2	50	-	2-11	2	5.55	4.11	3.75	141.0	104.4	95.3
20H56	2 1/2	50	2 1/2-8	-	2	6.14	4.11	3.75	156.0	104.4	95.3
20H56BS	2 1/2	50	-	2 1/2-11	2	6.14	4.11	3.75	156.0	104.4	95.3
20H61	2 1/2	50	3-8	-	2	7.00	4.11	4.00	177.8	104.4	101.6
20H61BS	2 1/2	50	-	3-11	2	7.00	4.11	4.00	177.8	104.4	101.6

A=Overall Length, B=Maximum Diameter

* ISO 7241-1 Series B does not include 1-1/4 inch body size couplings; therefore, Series 10HK is not covered by this standard

To obtain connected length of coupling, add dimensions A (Fig. 2) and E (Fig. 4) together.

FLUID TRANSFER
AND HYDRAULIC

PNEUMATIC

SPECIAL APPLICATIONS

DIAGNOSTIC

AGRICULTURE

REFRIGERANT

HK Series (Steel) ISO 7241-1 B Interchange

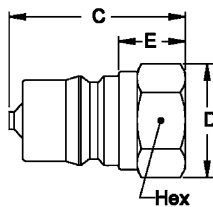

Figure 3

Plugs (Male)

Part Number HK1-8 Series	Body Size (in)	ISO Size (mm)	Thread Size (Female)			Fig.	Dimensions							
			NPTF	BSPB	SAE		C (in)	D (in)	E (in)	Hex (in)	C (mm)	D (mm)	E (mm)	Hex (mm)
1K11	1/8	5	1/8-27	-	-	3	1.26	0.65	0.44	0.56	32.0	16.5	11.2	14.2
1K4	1/8	5	-	-	7/16-20	3	1.41	0.79	0.59	0.69	35.8	20.1	15.0	17.5
2K16	1/4	6.3	1/4-18	-	-	3	1.52	0.87	0.56	0.75	38.6	22.1	14.2	19.1
2K16BS	1/4	6.3	-	1/4-19	-	3	1.52	0.87	0.56	0.75	38.6	22.1	14.2	19.1
2K6	1/4	6.3	-	-	9/16-18	3	1.66	1.01	0.70	0.88	42.2	25.7	17.8	22.4
3K21	3/8	10	3/8-18	-	-	3	1.76	1.01	0.61	0.88	44.7	25.7	15.5	22.4
3K21BS	3/8	10	-	3/8-19	-	3	1.76	1.01	0.61	0.88	44.7	25.7	15.5	22.4
3K8	3/8	10	-	-	3/4-16	3	1.94	1.15	0.79	1.00	49.3	29.2	20.1	25.4
4KP26	1/2	12.5	1/2-14	-	-	3	2.03	1.30	0.76	1.13	51.6	33.0	19.3	28.7
4KP26BS	1/2	12.5	-	1/2-14	-	3	2.03	1.30	0.76	1.13	51.6	33.0	19.3	28.7
4KP10	1/2	12.5	-	-	7/8-14	3	2.11	1.37	0.84	1.19	53.6	34.8	21.3	30.2
6KP31	3/4	20	3/4-14	-	-	3	2.36	1.52	0.71	1.31	59.9	38.6	18.0	33.3
6KP31BS	3/4	20	-	3/4-14	-	3	2.36	1.52	0.71	1.31	59.9	38.6	18.0	33.3
6KP12	3/4	20	-	-	1 1/8-12	3	2.54	1.59	0.89	1.38	64.5	40.4	22.6	35.1
8KP36	1	25	1-11 1/2	-	-	3	2.85	1.88	0.97	1.63	72.4	47.8	24.6	41.4
8KP36BS	1	25	-	1-11	-	3	2.85	1.88	0.97	1.63	72.4	47.8	24.6	41.4
8KP16	1	25	-	-	1 1/8-12	3	2.85	2.17	0.97	1.88	72.4	55.1	24.6	47.8

C=Overall Length, D=Maximum Diameter, E=Exposed Length when Connected
To obtain connected length of coupling, add dimensions A (Fig. 1) and E (Fig. 3) together.

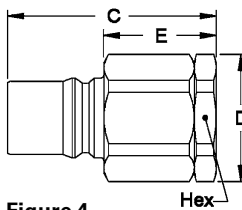

Figure 4

Plugs (Male)

Part Number HK10/12/20 Series	Body Size (in)	ISO Size (mm)	Thread Size (Female)		Fig.	Dimensions							
			NPTF	BSPB		C (in)	D (in)	E (in)	Hex (in)	C (mm)	D (mm)	E (mm)	Hex (mm)
10K41*	1 1/4	-	1 1/4-11 1/2	-	4	4.25	2.74	2.33	2.38	108.0	69.6	59.2	60.5
10K41BS*	1 1/4	-	-	1 1/4-11	4	4.25	2.74	2.33	2.38	108.0	69.6	59.2	60.5
12K41	1 1/2	40	1 1/4-11 1/2	-	4	4.76	2.74	2.67	2.38	120.9	69.6	67.8	60.5
12K41BS	1 1/2	40	-	1 1/4-11	4	4.76	2.74	2.67	2.38	120.9	69.6	67.8	60.5
12K46	1 1/2	40	1 1/2-11 1/2	-	4	4.76	2.74	2.67	2.38	120.9	69.6	67.8	60.5
12K46BS	1 1/2	40	-	1 1/2-11	4	4.76	2.74	2.67	2.38	120.9	69.6	67.8	60.5
20K51	2 1/2	60	2-11 1/2	-	4	5.49	4.33	2.97	3.75	139.4	110.0	75.4	95.3
20K51BS	2 1/2	60	-	2-11	4	5.49	4.33	2.97	3.75	139.4	110.0	75.4	95.3
20K56	2 1/2	60	2 1/2-8	-	4	6.08	4.33	3.56	3.75	154.4	110.0	90.4	95.3
20K56BS	2 1/2	60	-	2 1/2-11	4	6.08	4.33	3.56	3.75	154.4	110.0	90.4	95.3
20K61	2 1/2	60	3-8	-	4	6.94	4.62	4.42	4.00	176.3	117.3	112.3	101.6
20K61BS	2 1/2	60	-	3-11	4	6.94	4.62	4.42	4.00	176.3	117.3	112.3	101.6

C=Overall Length, D=Maximum Diameter, E=Exposed Length when Connected
* ISO 7241-1 Series B does not include 1-1/4 inch body size couplings; therefore, Series 10HK is not covered by this standard
To obtain connected length of coupling, add dimensions A (Fig. 2) and E (Fig. 4) together.

Dust Plugs and Dust Caps Accessories

Coupling Series	Plug Dust Cap Part No.		Socket Dust Plug Part No.	
	Metal	Vinyl	Metal	Vinyl
1HK	PDC1HK*	PPDC1HK	SDC1HK*	PSDC1HK
2HK	PDC2HK*	PPDC2HK	SDC2HK*	PSDC2HK
3HK	PDC3HK*	PPDC3HK	SDC3HK*	PSDC3HK
4HK	PDC4HK**	PPDC4HK(RD)***	SDC4HK**	PSDC4HK(RD)***
6HK	PDC6HK**	PPDC6HK(RD)***	SDC6HK**	PSDC6HK(RD)***
8HK	PDC8HK**	PPDC8HK(RD)***	SDC8HK**	PSDC8HK(RD)***
12HK	PDC12HK*	-	SDC12HK*	-
20HK	PDC20HK*	-	SDC20HK*	-

*Brass **Aluminum ***Offered in red by adding RD to end of part number



FLUID TRANSFER
AND HYDRAULIC

PNEUMATIC

SPECIAL APPLICATIONS

DIAGNOSTIC

AGRICULTURE

REFRIGERANT

HK Series (Brass)

ISO 7241-1 B Interchange



Eaton's HK brass is a general purpose industrial interchange coupling available in valved or non-valved designs, offered in brass for excellent corrosion resistance in rugged applications where stainless steel is unacceptable. The HK Series features a ball latch mechanism with automatic self-sealing poppet valves.

Product Features

- Meets dimensional requirements to ISO standard 7241-1 Series B
- Brass construction with stainless steel springs for greater corrosion resistance and fluid compatibility
- Self-sealing poppet valves provide excellent high and low pressure sealing
- Standard seal material: Buna-N
- Seal options available in PTFE, Neoprene, FKM, EPDM, and Kalrez®

Physical Characteristics

Series	Body Size (in)	ISO Size (mm)	Nominal Flow Diameter (mm)	Max. Operating Pressure				Rated Flow*		Air Inclusion	Fluid Loss
				Non hazardous liquids & gases Group 2 (bar)	(psi)	Hazardous liquids & gases Group 1 (bar)	(psi)	(lpm)	(gpm)	cc. max.	cc. max.
1HK	1/8	5	4.4	207	3,000	207	3,000	3	0.8	0.6	0.5
2HK	1/4	6.3	5.9	186	2,700	186	2,700	12	3	1.2	0.9
3HK	3/8	10	7.8	152	2,200	152	2,200	23	6	2.9	2.1
4HK	1/2	12.5	10	155	2,250	155	2,250	45	12	3.6	3.5
6HK	3/4	20	17	138	2,000	138	2,000	100	26	11.5	9.3
8HK	1	25	19.6	103	1,500	103	1,500	189	50	18.0	16.9
10HK	1 1/4**	—	26.7	83	1,200	37	537	288	76	48.0	48.0
12HK	1 1/2	40	35.1	104	1,500	29	421	375	99	91.3	91.3
20HK	2 1/2	50	46	49	700	21	305	757	200	209.9	209.9

* For questions related to vacuum please contact Eaton.

** No ISO Standard available for the 10HK

Applications & Markets

- Agriculture
- Hydraulic Tool
- General Industry
- Construction
- Fluid Transfer
- Chemical
- Oil and Gas
- Transportation
- Food and Beverage
- Trucks
- Nuclear

European Pressure Equipment Directive

Couplings with nominal diameters up to and including 25 mm are designed and manufactured under Article 4.3 of the European Pressure Equipment Directive 2014/68/EU. Couplings with nominal diameters greater than 25 mm are designed and manufactured in accordance with stipulations of Module A of the European Pressure Equipment Directive 2014/68/EU. They should not be used to convey unstable gases.

Group 1 = Hazardous media / Group 2 = Other media

Flow Data

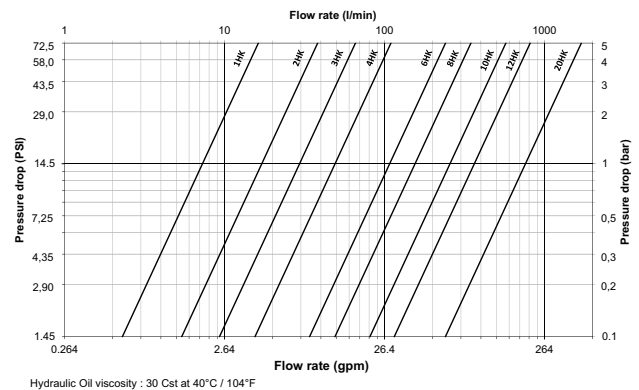

Seal Elastomer Data*

Seal Elastomer	Max. Operation Temperature Range
Buna-N	-40°C to +121°C/40°F to +250°F
Neoprene	-54°C to +100°C/-65°F to +212°F
EPDM	-54°C to +149°C/-65°C to +300°F
FKM	-29°C to +204°C/-15°F to +400°F

* For reference only, based on Eaton recommended temperatures. Contact Eaton technical support for further information on fluid compatibility.

HK Series (Brass) ISO 7241-1 B Interchange

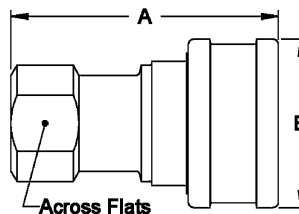

Figure 1

Sockets (Female)

Part Number HK1-8 Series	Body Size (in)	ISO Size (mm)	Thread Size (Female)		Fig.	Dimensions					
			NPTF	BSPP		A (in)	B (in)	Across Flats (in)	A (mm)	B (mm)	Across Flats (mm)
B1H11	1/8	5	1/8-27	-	1	1.91	0.98	0.56	48.5	24.9	14.2
B2H16	1/4	6.3	1/4-18	-	1	2.26	1.14	0.75	57.4	29.0	19.1
B2H16BS	1/4	6.3	-	1/4-19	1	2.31	1.14	0.75	58.7	29.0	19.1
B3H21	3/8	10	3/8-18	-	1	2.56	1.42	0.88	65.0	36.1	22.4
B3H21BS	3/8	10	-	3/8-19	1	2.56	1.42	0.88	65.0	36.1	22.4
B4HP26	1/2	12.5	1/2-14	-	1	2.96	1.86	1.13	75.2	47.2	28.7
B4HP26BS	1/2	12.5	-	1/2-14	1	2.96	1.86	1.13	75.2	47.2	28.7
B6HP31	3/4	20	3/4-14	-	1	3.48	2.22	1.31	88.4	56.4	33.3
B6HP31BS	3/4	20	-	3/4-14	1	3.48	2.22	1.31	88.4	56.4	33.3
B8HP36	1	25	1-11 1/2	-	1	4.13	2.61	1.75	104.9	66.3	44.5
B8HP36BS	1	25	-	1-11	1	4.13	2.61	1.75	104.9	66.3	44.5

A=Overall Length, B=Maximum Diameter

To obtain connected length of coupling, add dimensions A (Fig. 1) and E (Fig. 3) together.

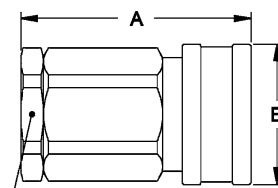

Figure 2

Sockets (Female)

Part Number HK10/12/20 Series	Body Size (in)	ISO Size (mm)	Thread Size (Female)		Fig.	Dimensions					
			NPTF	BSPP		A (in)	B (in)	Hex (in)	A (mm)	B (mm)	Hex (mm)
B10H41*	1 1/4	-	1 1/4-11 1/2	-	2	4.51	2.73	2.38	114.6	69.3	60.5
B12H41	1 1/2	40	1 1/4-11 1/2	-	2	4.82	3.23	2.38	122.4	82.0	60.5
B12H41BS	1 1/2	40	-	1 1/4-11	2	4.82	3.23	2.38	122.4	82.0	60.5
B12H46	1 1/2	40	1 1/2-11	-	2	4.82	3.23	2.38	122.4	82.0	60.5
B12H46BS	1 1/2	40	-	1 1/2-11	2	4.82	3.23	2.38	122.4	82.0	60.5
B20H51	2 1/2	50	2-11 1/2	-	2	5.55	4.11	3.75	141.0	104.4	95.3
B20H51BS	2 1/2	50	-	2-11	2	5.55	4.11	3.75	141.0	104.4	95.3
B20H56	2 1/2	50	2 1/2-8	-	2	6.14	4.11	3.75	156.0	104.4	95.3
B20H56BS	2 1/2	50	-	2 1/2-11	2	6.14	4.11	3.75	156.0	104.4	95.3
B20H61	2 1/2	50	3-8	-	2	7.00	4.11	4.00	177.8	104.4	101.6
B20H61BS	2 1/2	50	-	3-11	2	7.00	4.11	4.00	177.8	104.4	101.6

A=Overall Length, B=Maximum Diameter

* ISO 7241-1 Series B does not include 1-1/4 inch body size couplings; therefore, Series 10HK is not covered by this standard

To obtain connected length of coupling, add dimensions A (Fig. 2) and E (Fig. 4) together.



HK Series (Brass) ISO 7241-1 B Interchange

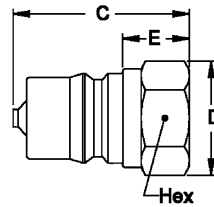

Figure 3

Plugs (Male)

Part Number HK1-8 Series	Body Size (in)	ISO Size (mm)	Thread Size (Female)		Fig.	Dimensions							
			NPTF	BSPP		C (in)	D (in)	E (in)	Hex (in)	C (mm)	D (mm)	E (mm)	Hex (mm)
B1K11	1/8	5	1/8-27	-	3	1.26	0.65	0.44	0.56	32.0	16.5	11.2	14.2
B2K16	1/4	6.3	1/4-18	-	3	1.52	0.87	0.56	0.75	38.6	22.1	14.2	19.1
B2K16BS	1/4	6.3	-	1/4-19	3	1.52	0.87	0.56	0.75	38.6	22.1	14.2	19.1
B3K21	3/8	10	3/8-18	-	3	1.76	1.01	0.61	0.88	44.7	25.7	15.5	22.4
B3K21BS	3/8	10	-	3/8-19	3	1.76	1.01	0.61	0.88	44.7	25.7	15.5	22.4
B4K26	1/2	12.5	1/2-14	-	3	2.03	1.30	0.76	1.13	51.6	33.0	19.3	28.7
B4K26BS	1/2	12.5	-	1/2-14	3	2.03	1.30	0.76	1.13	51.6	33.0	19.3	28.7
B6K31	3/4	20	3/4-14	-	3	2.36	1.52	0.71	1.31	59.9	38.6	18.0	33.3
B6K31BS	3/4	20	-	3/4-14	3	2.36	1.52	0.71	1.31	59.9	38.6	18.0	33.3
B8K36	1	25	1-11 1/2	-	3	2.85	1.88	0.97	1.63	72.4	47.8	24.6	41.4
B8K36BS	1	25	-	1-11	3	2.85	1.88	0.97	1.63	72.4	47.8	24.6	41.4

C=Overall Length, D=Maximum Diameter, E=Exposed Length when Connected
To obtain connected length of coupling, add dimensions A (Fig. 1) and E (Fig. 3) together.

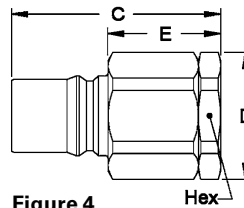

Figure 4

Plugs (Male)

Part Number HK10/12/20 Series	Body Size (in)	ISO Size (mm)	Thread Size (Female)		Fig.	Dimensions							
			NPTF	BSPP		C (in)	D (in)	E (in)	Hex (in)	C (mm)	D (mm)	E (mm)	Hex (mm)
B10K41*	1 1/4	-	1 1/4-11 1/2	-	4	4.25	2.74	2.33	2.38	108.0	69.6	59.2	60.5
B12K41	1 1/2	40	1 1/4-11 1/2	-	4	4.76	2.74	2.67	2.38	120.9	69.6	67.8	60.5
B12K41BS	1 1/2	40	-	1 1/4-11	4	4.76	2.74	2.67	2.38	120.9	69.6	67.8	60.5
B12K46	1 1/2	40	1 1/2-11 1/2	-	4	4.76	2.74	2.67	2.38	120.9	69.6	67.8	60.5
B12K46BS	1 1/2	40	-	1 1/2-11	4	4.76	2.74	2.67	2.38	120.9	69.6	67.8	60.5
B20K51	2 1/2	50	2-11 1/2	-	4	5.49	4.33	2.97	3.75	139.4	110.0	75.4	95.3
B20K51BS	2 1/2	50	-	2-11	4	5.49	4.33	2.97	3.75	139.4	110.0	75.4	95.3
B20K56	2 1/2	50	2 1/2-8	-	4	6.08	4.33	3.56	3.75	154.4	110.0	90.4	95.3
B20K56BS	2 1/2	50	-	2 1/2-11	4	6.08	4.33	3.56	3.75	154.4	110.0	90.4	95.3
B20K61	2 1/2	50	3-8	-	4	6.94	4.62	4.42	4.00	176.3	117.3	112.3	101.6
B20K61BS	2 1/2	50	-	3-11	4	6.94	4.62	4.42	4.00	176.3	117.3	112.3	101.6

C=Overall Length, D=Maximum Diameter, E=Exposed Length when Connected
* ISO 7241-1 Series B does not include 1-1/4 inch body size couplings; therefore, Series 10HK is not covered by this standard
To obtain connected length of coupling, add dimensions A (Fig. 2) and E (Fig. 4) together.

Dust Plugs and Dust Caps Accessories

Coupling Series	Plug Dust Cap Part No.		Socket Dust Plug Part No.	
	Metal	Vinyl	Metal	Vinyl
1HK	PDC1HK*	PPDC1HK	SDC1HK*	PSDC1HK
2HK	PDC2HK*	PPDC2HK	SDC2HK*	PSDC2HK
3HK	PDC3HK*	PPDC3HK	SDC3HK*	PSDC3HK
4HK	PDC4HK**	PPDC4HK(RD)***	SDC4HK**	PSDC4HK(RD)***
6HK	PDC6HK**	PPDC6HK(RD)***	SDC6HK**	PSDC6HK(RD)***
8HK	PDC8HK**	PPDC8HK(RD)***	SDC8HK**	PSDC8HK(RD)***
12HK	PDC12HK*		SDC12HK*	
20HK	PDC20HK*		SDC20HK*	

*Brass **Aluminum ***Offered in red by adding RD to end of part number



FLUID TRANSFER AND HYDRAULIC
PNEUMATIC
SPECIAL APPLICATIONS
DIAGNOSTIC
AGRICULTURE
REFRIGERANT

HK Series Series (Stainless Steel) ISO 7241-1 B Interchange



Eaton's HK stainless steel is a general purpose industrial interchange coupling available in valved or non-valved designs, offered in 303/316 grades of stainless steel for excellent corrosion resistance in rugged applications. The HK Series features a ball latch mechanism with automatic self-sealing poppet valves.

Product Features

- Meets dimensional requirements to ISO standard 7241-1 Series B
- 303/316 Stainless steel construction for greater corrosion resistance and fluid compatibility
- Self-sealing poppet valves provide excellent high and low pressure sealing
- Standard body material: 303 or 316 Stainless Steel
- Standard seal material: Buna-N
- Seal options available in PTFE, Neoprene, FKM, EPDM, and Kalrez®

Physical Characteristics

Series	Body Size (in)	ISO Size (mm)	Nominal Flow Diameter (mm)	Max. Operating Pressure				Rated Flow*		Air Inclusion cc. max.	Fluid Loss cc. max.
				Non hazardous liquids & gases Group 2		Hazardous liquids & gases Group 1		lpm	gpm		
				(bar)	(psi)	(bar)	(psi)				
1HK	1/8	5	4.4	344	5,000	344	5,000	3	0.8	0.6	0.5
2HK	1/4	6.3	5.9	255	3,700	255	3,700	12	3	1.2	0.9
3HK	3/8	10	7.8	255	3,700	255	3,700	23	6	2.9	2.1
4HK	1/2	12.5	10	293	4,250	293	4,250	45	12	3.6	3.5
6HK	3/4	20	17	242	3,500	242	3,500	100	26	11.5	9.3
8HK	1	25	19.6	207	3,000	207	3,000	189	50	18.0	16.9
10HK	1 1/4**	—	26.7	118	1,700	37	537	288	76	48.0	48.0
12HK	1 1/2	40	35.1	152	2,200	29	421	375	99	91.3	91.3
20HK	2 1/2	50	46	104	1,500	21	305	757	200	209.9	209.9

* For questions related to vacuum please contact Eaton.

** No ISO Standard available for the 10HK

Applications & Markets

- Agriculture
- Hydraulic Tool
- General Industry
- Construction
- Fluid Transfer
- Transportation
- Military
- Law Enforcement/Rescue
- Chemical
- Oil and Gas
- Consumer Products
- HVAC
- Food and Beverage
- Trucks
- Aerospace
- Medical

European Pressure Equipment Directive

Couplings with nominal diameters up to and including 25 mm are designed and manufactured under Article 4.3 of the European Pressure Equipment Directive 2014/68/EU. Couplings with nominal diameters greater than 25 mm are designed and manufactured in accordance with stipulations of Module A of the European Pressure Equipment Directive 2014/68/EU. They should not be used to convey unstable gases.

Group 1 = Hazardous media / Group 2 = Other media

Flow Data

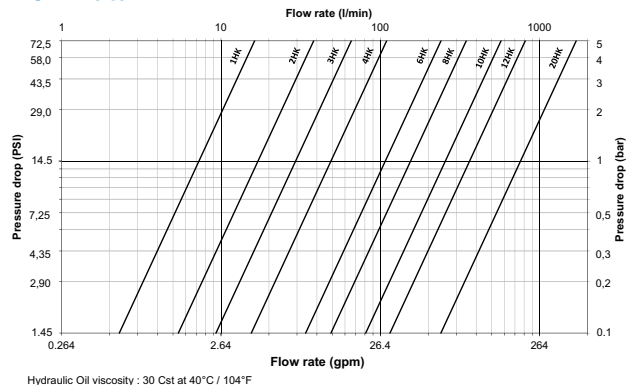

Seal Elastomer Data*

Seal Elastomer	Max. Operation Temperature Range
Buna-N	-40°C to +121°C/40°F to +250°F
Neoprene	-54°C to +100°C/-65°F to +212°F
EPDM	-54°C to +149°C/-65°C to +300°F
FKM	-29°C to +204°C/-15°F to +400°F

*For reference only, based on Eaton recommended temperatures. Contact Eaton technical support for further information on fluid compatibility.

HK Series Series (Stainless Steel) ISO 7241-1 B Interchange

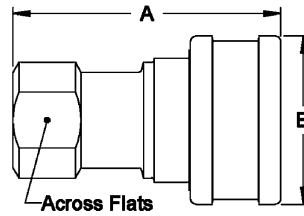

Figure 1

Sockets (Female)

Part Number HK1-8 Series 303 Stainless Steel	316 Stainless Steel	Body Size	ISO Size	Thread Size (Female)			Fig.	Dimensions					
				NPTF	BSPP	SAE		A (in)	B (in)	Across Flats (in)	A (mm)	B (mm)	Across Flats (mm)
LL1H11	ML1H11	1/8	5	1/8-27	-	-	1	1.91	0.98	0.56	48.5	24.9	14.2
LL1H4	-	1/8	5	-	-	7/8-20	1	2.06	0.98	0.69	52.3	24.9	17.5
LL2H16	ML2H16	1/4	6.3	1/4-18	-	-	1	2.26	1.14	0.75	57.4	29.0	19.1
LL2H16BS	ML2H16BS	1/4	6.3	-	1/4-19	-	1	2.31	1.14	0.75	58.7	29.0	19.1
LL2H6	-	1/4	6.3	-	-	9/16-18	1	2.40	1.14	0.88	61.0	29.0	22.4
LL3H21	ML3H21	3/8	10	3/8-18	-	-	1	2.56	1.42	0.88	65.0	36.1	22.4
LL3H21BS	ML3H21BS	3/8	10	-	3/8-19	-	1	2.56	1.42	0.88	65.0	36.1	22.4
LL3H8	-	3/8	10	-	-	3/4-16	1	2.74	1.42	1.00	69.6	36.1	25.4
LL4HP26	ML4HP26	1/2	12.5	1/2-14	-	-	1	2.96	1.86	1.13	75.2	47.2	28.7
LL4HP26BS	ML4HP26BS	1/2	12.5	-	1/2-14	-	1	2.96	1.86	1.13	75.2	47.2	28.7
LL4HP10	-	1/2	12.5	-	-	7/8-14	1	3.05	1.86	1.25	77.5	47.2	31.8
LL6HP31	ML6HP31	3/4	20	3/4-14	-	-	1	3.48	2.22	1.31	88.4	56.4	33.3
LL6HP31BS	ML6HP31BS	3/4	20	-	3/4-14	-	1	3.48	2.22	1.31	88.4	56.4	33.3
LL6HP12	-	3/4	20	-	-	1 1/16-12	1	3.67	2.22	1.38	93.2	56.4	35.1
LL8HP36	ML8HP36	1	25	1-11 1/2	-	-	1	4.13	2.61	1.75	104.9	66.3	44.5
LL8HP36BS	ML8HP36BS	1	25	-	1-11	-	1	4.13	2.61	1.75	104.9	66.3	44.5
LL8HP16	-	1	25	-	-	1 1/8-12	1	4.13	2.61	1.88	104.9	66.3	47.8

A=Overall Length, B=Maximum Diameter

To obtain connected length of coupling, add dimensions A (Fig. 1) and E (Fig. 3) together.

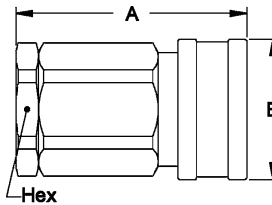

Figure 2

Sockets (Female)

Part Number HK10/12/20 Series 303 Stainless Steel	Body Size	ISO Size	Thread Size (Female)		Fig.	Dimensions					
			NPTF	BSPP		A (in)	B (in)	Hex (in)	A (mm)	B (mm)	Hex (mm)
LL10H41*	1 1/4	-	1 1/4-11 1/2	-	2	4.51	2.73	2.38	114.6	69.3	60.5
LL10H41BS*	1 1/4	-	-	1 1/4-11	2	4.51	2.73	2.38	114.6	69.3	60.5
LL12H41	1 1/2	40	1 1/4-11 1/2	-	2	4.82	3.23	2.38	122.4	82.0	60.5
LL12H41BS	1 1/2	40	-	1 1/4-11	2	4.82	3.23	2.38	122.4	82.0	60.5
LL12H46	1 1/2	40	1 1/2-11 1/2	-	2	4.82	3.23	2.38	122.4	82.0	60.5
LL12H46BS	1 1/2	40	-	1 1/2-11	2	4.82	3.23	2.38	122.4	82.0	60.5
LL20H51	2 1/2	50	2-11 1/2	-	2	5.55	4.11	3.75	141.0	104.4	95.3
LL20H51BS	2 1/2	50	-	2-11	2	5.55	4.11	3.75	141.0	104.4	95.3
LL20H56	2 1/2	50	2 1/2-8	-	2	6.14	4.11	3.75	156.0	104.4	95.3
LL20H56BS	2 1/2	50	-	2 1/2-11	2	6.14	4.11	3.75	156.0	104.4	95.3
LL20H61	2 1/2	50	3-8	-	2	7.00	4.11	4.00	177.8	104.4	101.6
LL20H61BS	2 1/2	50	-	3-11	2	7.00	4.11	4.00	177.8	104.4	101.6

A=Overall Length, B=Maximum Diameter

* ISO 7241-1 Series B does not include 1-1/4 inch body size couplings; therefore, Series 10HK is not covered by this standard.

To obtain connected length of coupling, add dimensions A (Fig. 2) and E (Fig. 4) together.

FLUID TRANSFER
AND HYDRAULIC

PNEUMATIC

SPECIAL APPLICATIONS

DIAGNOSTIC

AGRICULTURE

REFRIGERANT

HK Series (Stainless Steel) ISO 7241-1 B Interchange

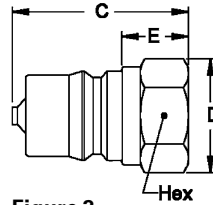

Figure 3

Plugs (Male)

Part Number HK1-8 Series 303		Body Size 316	ISO Size	Thread Size (Female)			Fig.	Dimensions							
		(in)	(mm)	NPTF	BSPB	SAE		C (in)	D (in)	E (in)	Hex (in)	C (mm)	D (mm)	E (mm)	Hex (mm)
LL1K11	ML1K11	1/8	5	1/8-27	-	-	3	1.26	0.65	0.44	0.56	32.0	16.5	11.2	14.2
LL1K4	-	1/8	5	-	-	7/16-20	3	1.41	0.79	0.59	0.69	35.8	20.1	15.0	17.5
LL2K16	ML2K16	1/4	6.3	1/4-18	-	-	3	1.52	0.87	0.56	0.75	38.6	22.1	14.2	19.1
LL2K16BS	ML2K16BS	1/4	6.3	-	1/4-19	-	3	1.52	0.87	0.56	0.75	38.6	22.1	14.2	19.1
LL2K6	-	1/4	6.3	-	-	9/16-18	3	1.66	1.01	0.70	0.88	42.2	25.7	17.8	22.4
LL3K21	ML3K21	3/8	10	3/8-18	-	-	3	1.76	1.01	0.61	0.88	44.7	25.7	15.5	22.4
LL3K21BS	ML3K21BS	3/8	10	-	3/8-19	-	3	1.76	1.01	0.61	0.88	44.7	25.7	15.5	22.4
LL3K8	-	3/8	10	-	-	3/4-16	3	1.94	1.15	0.79	1.00	49.3	29.2	20.1	25.4
LL4KP26	ML4KP26	1/2	12.5	1/2-14	-	-	3	2.03	1.30	0.76	1.13	51.6	33.0	19.3	28.7
LL4KP26BS	ML4KP26BS	1/2	12.5	-	1/2-14	-	3	2.03	1.30	0.76	1.13	51.6	33.0	19.3	28.7
LL4KP10	-	1/2	12.5	-	-	7/8-14	3	2.11	1.37	0.84	1.19	53.6	34.8	21.3	30.2
LL6KP31	ML6KP31	3/4	20	3/4-14	-	-	3	2.36	1.52	0.71	1.31	59.9	38.6	18.0	33.3
LL6KP31BS	ML6KP31BS	3/4	20	-	3/4-14	-	3	2.36	1.52	0.71	1.31	59.9	38.6	18.0	33.3
LL6KP12	-	3/4	20	-	-	1 1/16-12	3	2.54	1.59	0.89	1.38	64.5	40.4	22.6	35.1
LL8KP36	ML8KP36	1	25	1-11 1/2	-	-	3	2.85	1.88	0.97	1.63	72.4	47.8	24.6	41.4
LL8KP36BS	ML8KP36BS	1	25	-	1-11	-	3	2.85	1.88	0.97	1.63	72.4	47.8	24.6	41.4
LL8KP16	-	1	25	-	-	1 1/16-12	3	2.85	2.17	0.97	1.88	72.4	55.1	24.6	47.8

C=Overall Length, D=Maximum Diameter, E=Exposed Length when Connected
To obtain connected length of coupling, add dimensions A (Fig. 1) and E (Fig. 3) together.

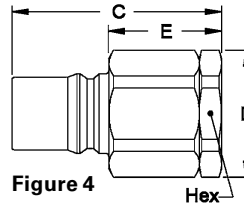

Figure 4

Plugs (Male)

Part Number HK10/12/20 Series 303 Stainless Steel		Body Size	ISO Size	Thread Size (Female)		Fig.	Dimensions							
		(in)	(mm)	NPTF	BSPB		C (in)	D (in)	E (in)	Hex (in)	C (mm)	D (mm)	E (mm)	Hex (mm)
LL10K41*		1 1/4	-	1 1/4-11 1/2	-	4	4.25	2.74	2.33	2.38	108.0	69.6	59.2	60.5
LL10K41BS*		1 1/4	-	-	1 1/4-11	4	4.25	2.74	2.33	2.38	108.0	69.6	59.2	60.5
LL12K41		1 1/2	40	1 1/4-11 1/2	-	4	4.76	2.74	2.67	2.38	120.9	69.6	67.8	60.5
LL12K41BS		1 1/2	40	-	1 1/4-11	4	4.76	2.74	2.67	2.38	120.9	69.6	67.8	60.5
LL12K46		1 1/2	40	1 1/2-11 1/2	-	4	4.76	2.74	2.67	2.38	120.9	69.6	67.8	60.5
LL12K46BS		1 1/2	40	-	1 1/2-11	4	4.76	2.74	2.67	2.38	120.9	69.6	67.8	60.5
LL20K51		2 1/2	50	2-11 1/2	-	4	5.49	4.33	2.97	3.75	139.4	110.0	75.4	95.3
LL20K51BS		2 1/2	50	-	2-11	4	5.49	4.33	2.97	3.75	139.4	110.0	75.4	95.3
LL20K56		2 1/2	50	2 1/2-8	-	4	6.08	4.33	3.56	3.75	154.4	110.0	90.4	95.3
LL20K56BS		2 1/2	50	-	2 1/2-11	4	6.08	4.33	3.56	3.75	154.4	110.0	90.4	95.3
LL20K61		2 1/2	50	3-8	-	4	6.94	4.62	4.42	4.00	176.3	117.3	112.3	101.6
LL20K61BS		2 1/2	50	-	3-11	4	6.94	4.62	4.42	4.00	176.3	117.3	112.3	101.6

C=Overall Length, D=Maximum Diameter, E=Exposed Length when Connected
* ISO 7241-1 Series B does not include 1-1/4 inch body size couplings; therefore, Series 10HK is not covered by this standard.
To obtain connected length of coupling, add dimensions A (Fig. 2) and E (Fig. 4) together.

Dust Plugs and Dust Caps Accessories

Coupling Series	Plug Dust Cap Part No.		Socket Dust Plug Part No.	
	Metal	Vinyl	Metal	Vinyl
1HK	PDC1HK*	PPDC1HK	SDC1HK*	PSDC1HK
2HK	PDC2HK*	PPDC2HK	SDC2HK*	PSDC2HK
3HK	PDC3HK*	PPDC3HK	SDC3HK*	PSDC3HK
4HK	PDC4HK**	PPDC4HK(RD)***	SDC4HK**	PSDC4HK(RD)***
6HK	PDC6HK**	PPDC6HK(RD)***	SDC6HK**	PSDC6HK(RD)***
8HK	PDC8HK**	PPDC8HK(RD)***	SDC8HK**	PSDC8HK(RD)***
12HK	PDC12HK*		SDC12HK*	
20HK	PDC20HK*		SDC20HK*	

*Brass **Aluminum ***Offered in red by adding RD to end of part number



FLUID TRANSFER
AND HYDRAULIC

PNEUMATIC

SPECIAL APPLICATIONS

DIAGNOSTIC

AGRICULTURE

REFRIGERANT

H15000 Series ISO 7241-1 A Interchange



The H15000 Series is a general purpose industrial interchange coupling that meets the ISO 7241-1 Series A standard. The H15000 Series features a rugged ball latch mechanism with self-sealing poppet valves.

Product Features

- Meets the requirements of ISO 7241-1 Series A
- Designed and manufactured under Article 4.3 of the European Pressure Equipment Directive 2014/68/EU.
- ½" size available in push-pull version(double acting sleeve, bulkhead-mounted)
- Double shut off valves with ball locking
- Standard body material: Zinc trivalent plated steel
- Standard seal material: NBR

Physical Characteristics

ISO Size	Coupling Size	Nominal Flow Diameter	Max. Operating Pressure		Rated Flow**		Fluid Loss
	(in)		(bar)	(psi)	(lpm)	(gpm)	
6.3	¼	5.3	315	4,565	10	2.6	0.35
10	⅜	7.3	315	4,565	20	5.3	1.5
12.5	½	10.2	250	3,625	40	10.6	2.6
20	¾	13	250	3,625	75	19.8	8.5
25	1	16.9	200	2,900	140	37	13

*The ISO size corresponds to the internal diameter of the hose or the external diameter of the rigid tube (as defined in ISO 4397 Standard).

**Indicated values refer to a 1 bar/14.5 psi pressure drop.

Applications & Markets

- Hydraulic Circuits and Equipment
- Hydraulic Fluids
- Agriculture

Flow Data

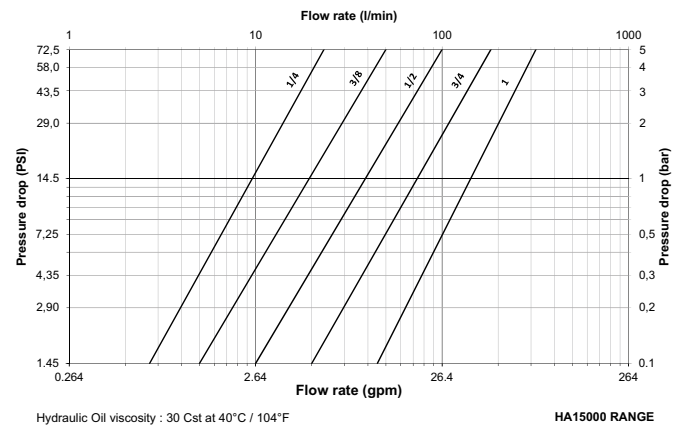

FLUID TRANSFER
AND HYDRAULIC

PNEUMATIC

SPECIAL APPLICATIONS

DIAGNOSTIC

AGRICULTURE

REFRIGERANT

H1 5000 Series ISO 7241-1 A Interchange

FLUID TRANSFER
AND HYDRAULIC

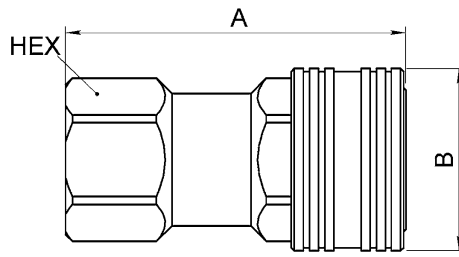

Figure 1

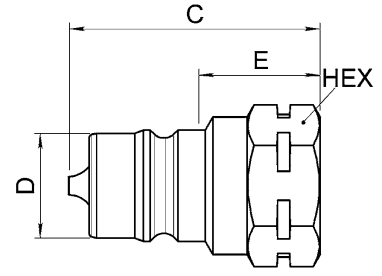

Figure 2

Part Number	Nominal Flow Diameter (mm)	ISO (mm)	Size (in)	Coupling Type	Thread Size	Fig.	Dimensions				Weight (g)
							A (mm)	B (mm)	Hex (mm)		
HA1501100	5.3	6.3	¼	Socket/Female	G ¼	1	48	25	19	94	
HA1521100	5.3	6.3	¼	Socket/Female	¼ NPT	1	48	25	19	94	
HA1502100	7.3	10	⅜	Socket/Female	G ⅜	1	56	30	23	139	
HA1522100	7.3	10	⅜	Socket/Female	⅜ NPT	1	56	30	23	139	
HA1503100	10.2	12.5	½	Socket/Female	G ½	1	67	38	27	238	
HA1503600	10.2	12.5	½	Socket/Female	G ½ push-pull	1	67	38	27	238	
HA1523100	10.2	12.5	½	Socket/Female	½ NPT	1	67	38	27	238	
HA1504100	13	20	¾	Socket/Female	G ¾	1	83	48	35	484	
HA1524100	13	20	¾	Socket/Female	¾ NPT	1	83	48	35	484	
HA1505100	16.9	25	1	Socket/Female	G 1	1	98	53	41	670	
HA1525100	16.9	25	1	Socket/Female	1 NPT	1	98	53	41	670	

Part Number	Nominal Flow Diameter (mm)	ISO (mm)	Size (in)	Coupling Type	Thread Size	Fig.	Dimensions				Weight (g)
							C (mm)	D (mm)	E (mm)	Hex (mm)	
HA1501200	5.3	6.3	¼	Plug/Male	G ¼	2	36	11.8	20	19	36
HA1521200	5.3	6.3	¼	Plug/Male	¼ NPT	2	36	11.8	20	19	36
HA1502200	7.3	10	⅜	Plug/Male	G ⅜	2	41.5	17.3	20	23	62
HA1522200	7.3	10	⅜	Plug/Male	⅜ NPT	2	41.5	17.3	20	23	62
HA1503200	10.2	12.5	½	Plug/Male	G ½	2	49	20.5	24	27	88
HA1523200	10.2	12.5	½	Plug/Male	½ NPT	2	49	20.5	24	27	88
HA1504200	13	20	¾	Plug/Male	G ¾	2	61.5	29.1	23	35	194
HA1524200	13	20	¾	Plug/Male	¾ NPT	2	61.5	29.1	27	35	194
HA1505200	16.9	25	1	Plug/Male	G 1	2	71.5	34.3	30	41	306
HA1525200	16.9	25	1	Plug/Male	1 NPT	2	71.5	34.3	30	41	306

To obtain connected length of coupling, add dimensions A (Fig. 1) and E (Fig. 2) together.

Dust Caps and Dust Plugs

Series	Dust Plug	Dust Cap
6.3	HP1511100	HP1511200
10	HP1512100	HP1512200
12.5	HP1513100	HP1513200
20	HP1514100	HP1514200
25	HP1515100	HP1515200



AGRICULTURE

Seal Kit for Servicing Sockets (Female)

Body size (in)	Seal & Back-up Ring Kit*	Qty
	NBR seals & PTFE back-up rings	
¼	HG 15011 00	50 O-rings + 50 Backup rings
⅜	HG 15021 00	50 O-rings + 50 Backup rings
½	HG 05031 00	50 O-rings + 50 Backup rings
¾	HG 15041 00	50 O-rings + 50 Backup rings
1	HG 15051 00	50 O-rings + 50 Backup rings

*The valve seal is not included in our repair kits

REFRIGERANT

5600 Series (Stainless Steel) ISO 7241-1 A Interchange



The Eaton 5600 Series is a rugged poppet style ball locking quick disconnect coupling. As the original manufacturer of the ISO 7241-1 A style coupling, Eaton has reinvented this quick disconnect coupling series to meet your application needs by offering a new stainless steel construction.

Product Features

- Self-sealing poppet valve provides excellent high and low pressure sealing
 - Stainless steel construction offers excellent corrosion resistance in tough environments
 - Standard body material: 303 stainless steel
 - Standard body material: Buna-N. EPDM and FKM seals are available upon request
 - Available sizes include: 5/8", 3/4", 1"*
 - Female NPTF thread ends
- *Additional sizes are available upon request.

Physical Characteristics

Body Size (in)	Max. Operating Pressure Connected		Min. Burst Pressure		Rated Flow		Air Inclusion	Fluid Loss
	(bar)	(psi)	(bar)	(psi)	(lpm)	(gpm)	cc. max.	cc.max.
5/8	207	3,000	621	9,000	45	12	2.8	2.8
3/4	207	3,000	621	9,000	106	28	10	8.2
1	207	3,000	621	9,000	189	50	14.2	14.2

Applications & Markets

- Hydraulic and Fluid Transfer
- Agricultural Equipment
- Construction Equipment
- Steel Mills
- Plant Manufacturing and Processing Equipment
- Dump, Snow Plow, and Maintenance Vehicles

Flow Data

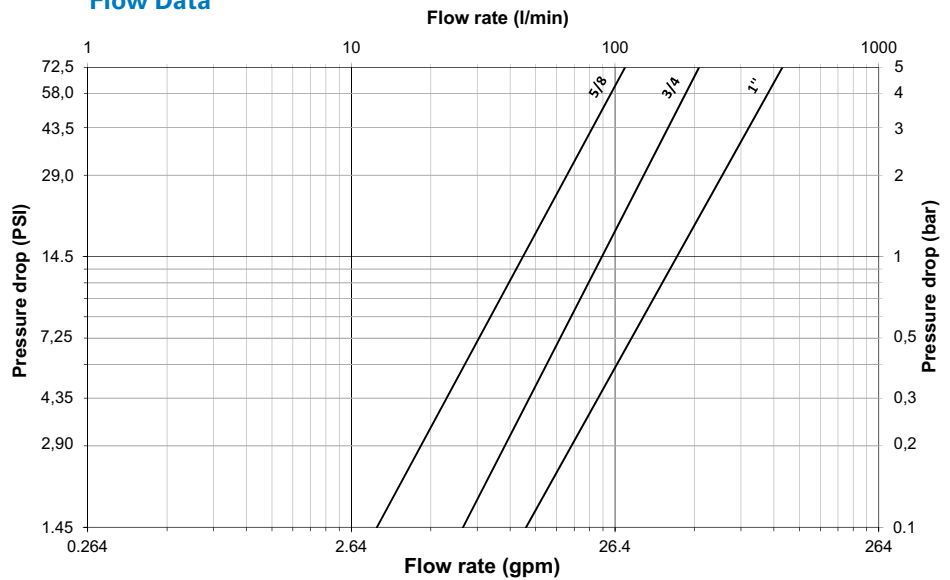

Hydraulic Oil viscosity : 30 Cst at 40°C / 104°F

5600 Series

FLUID TRANSFER
AND HYDRAULIC

PNEUMATIC

SPECIAL APPLICATIONS

DIAGNOSTIC

AGRICULTURE

REFRIGERANT

5600 Series (Stainless Steel) ISO 7241-1 A Interchange

FLUID TRANSFER
AND HYDRAULIC

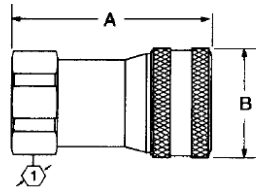

Figure 1

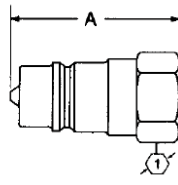

Figure 2

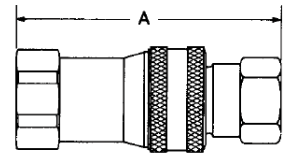

Figure 3

Female End Connections

Part Number	Coupling Type	Body Size	Thread	Fig.	Dimensions		Hex	A	B	Hex
					A	B				
					(in)	(in)	(in)	(mm)	(mm)	(mm)
560024-8-10	Socket/Female	5/8	1/2-14 NPTF	1	2.61	1.5	1.19	66.3	38.1	30.2
560024-12-12	Socket/Female	3/4	3/4-14 NPTF	1	3.25	1.81	1.50	82.6	46.0	38.1
560024-16-16	Socket/Female	1	1 11-1/2 NPTF	1	3.82	2.1	1.69	97.0	53.3	42.9

Plugs (Male)

Part Number	Coupling Type	Body Size	Thread	Fig.	Dimensions		Hex	A	B	Hex
					A	B				
					(in)	(in)	(in)	(mm)	(mm)	(mm)
560049-8-10	Plug/Male	5/8	1/2-14 NPTF	2	2.02	–	1.06	51.3	–	26.9
560049-12-12	Plug/Male	3/4	3/4-14 NPTF	2	2.55	–	1.38	64.8	–	35.1
560049-16-16	Plug/Male	1	1 11-1/2 NPTF	2	3.1	–	1.62	78.7	–	41.1

Complete Sets*

Part Number	Coupling Type	Body Size	Thread	Fig.	Dimensions	
					A	A
					(in)	(mm)
FD56-1001-08-10	Complete	5/8	1/2-14 NPTF	3	3.78	96.0
FD56-1001-12-12	Complete	3/4	3/4-14 NPTF	3	4.56	115.8
FD56-1001-16-16	Complete	1	1 11-1/2 NPTF	3	4.86	123.4

*Includes one socket/female and one plug/male half in the outlined size.

PNEUMATIC

SPECIAL APPLICATIONS

DIAGNOSTIC

AGRICULTURE

REFRIGERANT

IA Series ISO 7241-1 A Interchange



The IA Series meets ISO 7241-1 A Standard requirements and has a push-pull design, which allows the socket to be bulk-head-mounted. This configuration provides automatic connection or disconnection via a simple push or pull of the plug. Our IA Series is available in 1/2", with female or male end connections such as tube fittings, NPT, metric or SAE threads. It is widely used in agriculture and forestry applications.

Product Features

- ISO size: 12.5 mm (1/2")
- Standard body material: Zinc trivalent plated steel
- Wide offering of end connections, among which metric threads designed in accordance with ISO Standard 8434/1
- Standard seal material: NBR
- Optional PVC dust caps and plugs
- Designed and manufactured in accordance with Article 3.3 of the European Pressure Equipment Directive PED 201468/EU
- Meets dimensional requirements of ISO Standard 7241/1 Series A
- Push-to-connect: the push-pull sleeve on the bulkhead-mounted socket provides automatic connection or disconnection via a simple push or pull of the plug. In the event of pull on the hose, the double-action sleeve gives immediate and automatic disconnection

Physical Characteristics

Body Size (in)	ISO Size* (mm)	Nominal Flow Diameter (mm)	Max. Operating Pressure		Rated Flow**		Fluid Loss
			bar	(psi)	L/min	(gpm)	ml-cc.
1/2	12.5	6 8 10 10.3	250	3,625	45	11.9	2.6

* The ISO size corresponds to the internal diameter of the hose or the external diameter of the rigid tube (as defined in ISO 4397 Standard).

** Indicated values refer to a 1 bar/14.5 psi pressure drop.

Applications & Markets

- Agriculture
- Forestry Machinery

Flow Data

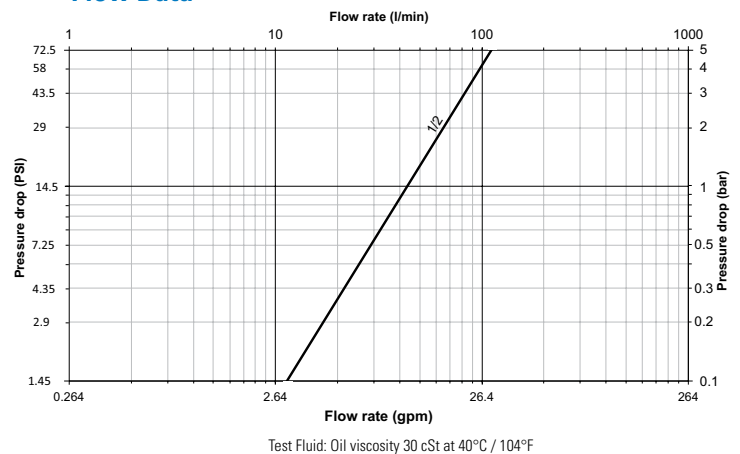

Seal Elastomer Data*

Seal Elastomer	Max. Operation Temperature Range
NBR (Nitrile)	-20°C +100°C/-4°F +212°F

*For reference only, based on Eaton recommended temperatures. Contact Eaton technical support for further information on fluid compatibility.

IA Series ISO 7241-1 A Interchange

FLUID TRANSFER
AND HYDRAULIC

PNEUMATIC

SPECIAL APPLICATIONS

DIAGNOSTIC

AGRICULTURE

REFRIGERANT

End Connections

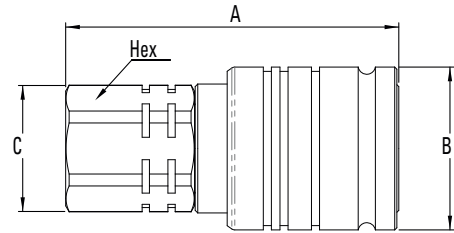
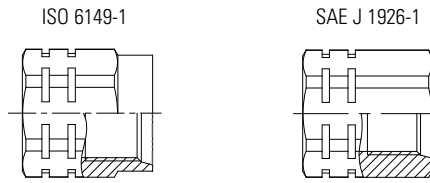

Sockets (Female) with Internal Thread

Part Number	Body Size	ISO Size	Nominal Flow Diameter	Thread Size (Female)			Dimensions							Weight				
				NPT	BSP	ISO 6149-1	SAE J 1926-1	Fig.	A (in)	B (in)	C (in)	Hex (in)	A (mm)	B (mm)	C (mm)	Hex (mm)	lbs	grams
12IAS37BS	½	12.5	10.3	-	¾-19	-	-	1	2.95	1.50	1.20	1.06	75	38	29.5	27	0.67	305
12IAS37				¾-18	-	-	1	2.95	1.50	1.20	1.06	75	38	29.5	27	0.67	305	
12IAS50BS				-	½-14	-	-	1	3.07	1.50	1.20	1.06	78	38	29.5	27	0.66	300
12IAS50				½-14	-	-	-	1	3.07	1.50	1.20	1.06	78	38	29.5	27	0.67	305
12IAS16FMET				-	-	M16x1.5	-	1	2.95	1.50	1.20	1.06	75	38	29.5	27	0.66	300
12IAS56UN				-	-	-	¾ 18f UNF	1	3.07	1.50	1.20	1.06	78	38	29.5	27	0.71	320
12IAS75UN				-	-	-	¾ 16f UNF	1	3.07	1.50	1.20	1.06	78	38	29.5	27	0.67	305
12IAS87UN				-	-	-	¾ 14f UNF	1	3.19	1.50	1.30	1.18	81	38	33	30	0.74	335

To obtain connected length of coupling add dimensions A (Fig. 1) and K (Fig. 3) or P (Fig. 4) together.

End Connections

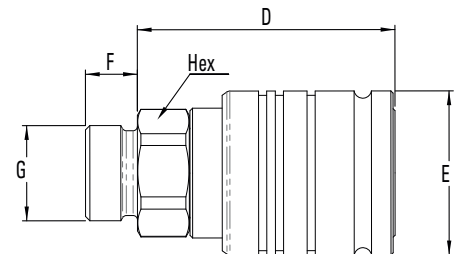
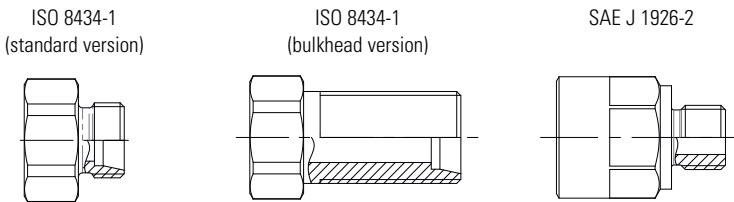

Sockets (Female) with External Thread

Part Number	Body Size	ISO Size	Nominal Flow Diameter	Thread Size (Male)			Dimensions							Weight				
				ISO 8434-1	SAE J 1926-2	Fig.	D (in)	E (in)	F (in)	G (in)	Hex (in)	D (mm)	E (mm)	F (mm)	G (mm)	Hex (mm)	lbs	grams
12IAS56ORM	½	12.5	10.3	-	¾ 18f UNF	2	2.87	1.50	0.47	0.56	0.94	73	38	12	14.2	23.8	0.67	305
12IAS75ORM			10.3	-	¾ 16f UNF	2	2.87	1.50	0.55	0.75	0.94	73	38	14	19	23.8	0.68	310
12IAS8L			6	8L - M14x1.5	-	2	2.44	1.50	0.39	0.55	1.06	62	38	10	14	27	0.61	275
12IAS10L			8	10L - M16x1.5	-	2	2.40	1.50	0.43	0.63	1.06	61	38	11	16	27	0.60	270
12IAS10LBH			8	10L - M16x1.5 Bulkhead	-	2	2.44	1.50	1.38	0.63	1.06	62	38	35	16	27	0.68	310
12IAS12L			10	12L - M18x1.5	-	2	2.40	1.50	0.43	0.71	1.06	61	38	11	18	27	0.61	275
12IAS12LBH			10	12L - M18x1.5 Bulkhead	-	2	2.40	1.50	1.42	0.71	1.06	61	38	36	18	27	0.70	316
12IAS12S			8	12S - M20x1.5	-	2	2.40	1.50	0.47	0.79	1.06	61	38	12	20	27	0.62	282
12IAS15L			10.3	15L - M22x1.5	-	2	2.36	1.50	0.47	0.87	1.06	60	38	12	22	27	0.61	275
12IAS15LBH			10.3	15L - M22x1.5 Bulkhead	-	2	2.40	1.50	1.50	0.87	1.06	61	38	38	22	27	0.75	340
12IAS16S	10.3	16S - M24x1.5	-	2	2.36	1.50	0.55	0.94	1.06	60	38	14	24	27	0.62	280		

To obtain connected length of coupling add dimensions D (Fig. 2) and K (Fig. 3) or P (Fig. 4) together.

IA Series ISO 7241-1 A Interchange

End Connections

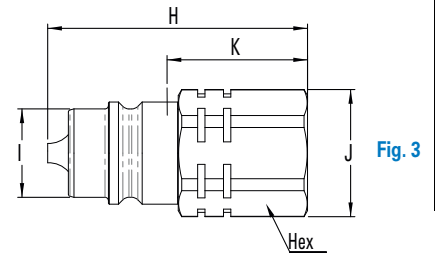
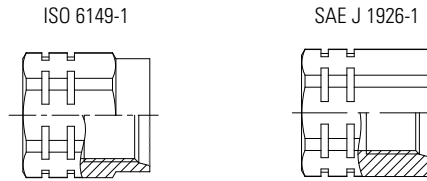

Fig. 3

Plugs (Male) with Internal Thread

Part Number	Body Size	ISO Size	Nominal Flow Diameter	Thread Size (Female)				Dimensions										Weight			
				NPT	BSPP	ISO 6149-1	SAE J 1926-1	Fig.	H	I	J	K	Hex	H	I	J	K	Hex	lbs	grams	
NBR	(in)	(mm)	(mm)						(in)	(in)	(in)	(in)	(in)	(in)	(mm)	(mm)	(mm)	(mm)	(mm)		
12IAP37BS				-	3/8-19	-	-	3	2.24	0.84	1.20	1.22	1.06	57	20.5	29.5	31	27	0.28	125	
12IAP37				3/8-18	-	-	-	3	2.24	0.84	1.20	1.22	1.06	57	20.5	29.5	31	27	0.29	130	
12IAP50BS				-	1/2-14	-	-	3	2.36	0.84	1.20	1.34	1.06	60	20.5	29.5	34	27	0.28	125	
12IAP50				1/2-14	-	-	-	3	2.36	0.84	1.20	1.34	1.06	60	20.5	29.5	34	27	0.28	125	
12IAP16FMET	1/2	12.5	10.3	-	-	M16x1.5	-	3	2.24	0.84	1.20	1.22	1.06	57	20.5	29.5	31	27	0.26	120	
12IAP56UN				-	-	-	3/8 18f UNF	3	2.36	0.84	1.20	1.34	1.06	60	20.5	29.5	34	27	0.31	140	
12IAP75UN				-	-	-	3/4 16f UNF	3	2.36	0.84	1.20	1.34	1.06	60	20.5	29.5	34	27	0.28	125	
12IAP87UN				-	-	-	7/8 14f UNF	3	2.48	0.84	1.30	1.46	1.18	63	20.5	33	37	30	0.34	155	

To obtain connected length of coupling add dimensions K (Fig. 3) and A (Fig. 1) or D (Fig. 2) together.

End Connections

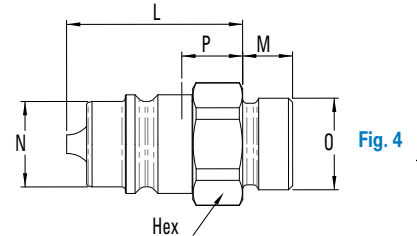
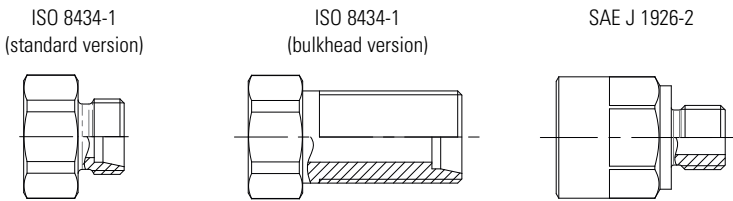

Fig. 4

Plugs (Male) with External Thread

Part Number	Body Size	ISO Size	Nominal Flow Diameter	Thread Size (Male)			Dimensions										Weight				
				ISO 8434-1	SAE J 1926-2	Fig.	L	M	N	O	P	Hex	L	M	N	O	P	Hex	lbs	grams	
NBR	(in)	(mm)	(mm)				(in)	(in)	(in)	(in)	(in)	(in)	(in)	(mm)	(mm)	(mm)	(mm)	(mm)	(mm)		
12IAP56ORM			10.3	-	3/8 18f UNF	4	2.20	0.47	0.84	0.56	1.18	0.94	56	12	20.5	14.2	30	23.8	0.28	125	
12IAP75ORM			10.3	-	3/4 16f UNF	4	2.20	0.55	0.84	0.75	1.18	0.94	56	14	20.5	19	30	23.8	0.29	130	
12IAP8L			6	8L - M14x1.5	-	4	1.75	0.39	0.84	0.55	0.71	1.06	44.5	10	20.5	14	18	27	0.21	95	
12IAP10L			8	10L - M16x1.5	-	4	1.71	0.43	0.84	0.63	0.67	1.06	43.5	11	20.5	16	17	27	0.21	95	
12IAP10LBH			8	10L - M16x1.5 Bulkhead	-	4	1.75	1.38	0.84	0.63	0.71	1.06	44.5	35	20.5	16	18	27	0.30	135	
12IAP12L	1/2	12.5	10	12L - M18x1.5	-	4	1.71	0.43	0.84	0.71	0.67	1.06	43.5	11	20.5	18	17	27	0.21	95	
12IAP12LBH			10	12L - M18x1.5 Bulkhead	-	4	1.71	1.42	0.84	0.71	0.67	1.06	43.5	36	20.5	18	17	27	0.30	136	
12IAP12S			8	12S - M20x1.5	-	4	1.71	0.47	0.84	0.79	0.67	1.06	43.5	12	20.5	20	17	27	0.22	102	
12IAP15L			10.3	15L - M22x1.5	-	4	1.67	0.47	0.84	0.87	0.63	1.06	42.5	12	20.5	22	16	27	0.21	95	
12IAP15LBH			10.3	15L - M22x1.5 Bulkhead	-	4	1.71	1.50	0.84	0.87	0.67	1.06	43.5	38	20.5	22	17	27	0.35	160	
12IAP16S			10.3	16S - M24x1.5	-	4	1.67	0.55	0.84	0.94	0.63	1.06	42.5	14	20.5	24	16	27	0.22	100	

To obtain connected length of coupling add dimensions P (Fig. 4) and A (Fig. 1) or D (Fig. 2) together.

Dust Plugs and Dust Caps

Body Size	Socket Dust Plug Part Number	Plug Dust Cap Part Number
(in)	Plastic	Plastic
1/2	HP1513100	HP1513200



FLUID TRANSFER
AND HYDRAULIC

PNEUMATIC

SPECIAL APPLICATIONS

DIAGNOSTIC

AGRICULTURE

REFRIGERANT

H5000 Series (Steel)



Eaton's H5000 Series steel quick disconnect coupling is a pull to connect double shut-off coupling. Featuring the original Eaton's Gromelle™ profile, it remains as the series users prefer when it comes to severe hydraulic applications such as high pressure, pressure impulses, heavy mechanical loads and frequent connection and disconnection cycles. The unique sleeve lock option offers a reliable solution and benefit to the end user when safety is a concern.

Product Features

- Proprietary profile
- Pull-to-connect with double shut-off valving
- Ball-locking
- Optional safety sleeve lock prevents accidental disconnections
- Optional dust caps and plugs (made of anodized aluminum)
- Pressure performance
- Standard body material: Zinc trivalent steel
- Standard seal material: NBR, FKM, EPDM
- The heat treatment of the plug and use of high strength steel for the socket sleeve provide superior mechanical and hydraulic performance. The design of the valve gives the coupling increased robustness when disconnected.

Physical Characteristics

Body Size (in)	Nominal Flow Diameter (mm)	Max. Operating Pressure*		Hazardous liquids & gases in Group 1		Rated Flow**		Fluid Loss (ml-cc.)
		(bar)	(psi)	(bar)	(psi)	(lpm)	(gpm)	
1/8	3.8	1,000	14,500	1,000	14,500	6.1	1.61	0.4
1/4	5.7	700	10,150	700	10,150	11.6	3.06	1
3/8	7.6	600	8,700	600	8,700	16.7	4.41	2
1/2	10.3	500	7,250	500	7,250	25.5	6.74	2.5
3/4	14.2	400	5,800	400	5,800	55	14.53	5.5
1	16.5	300	4,350	300	4,350	87	22.98	9
1 1/4	20.5	200	2,900	200	2,900	140	36.98	23
1 1/2	25.8	150	2,175	38	550	208	54.95	36
2	34.7	100	1,450	28	405	357	94.3	70

* For pulsating pressures when disconnected apply a multiplier of 0.5
 ** Indicated values refer to a 1 bar/14.5 psi pressure drop.

European Pressure Equipment Directive

Couplings with nominal diameters up to and including 25 mm are designed and manufactured under Article 4.3 of the European Pressure Equipment Directive 2014/68/EU. Couplings with nominal diameters greater than 25 mm are designed and manufactured in accordance with the stipulations of Module A of the European Pressure Equipment Directive 2014/68/EU. They should not be used to convey unstable gases.
 Group 1 = Hazardous media / Group 2 = Other media

Flow Data

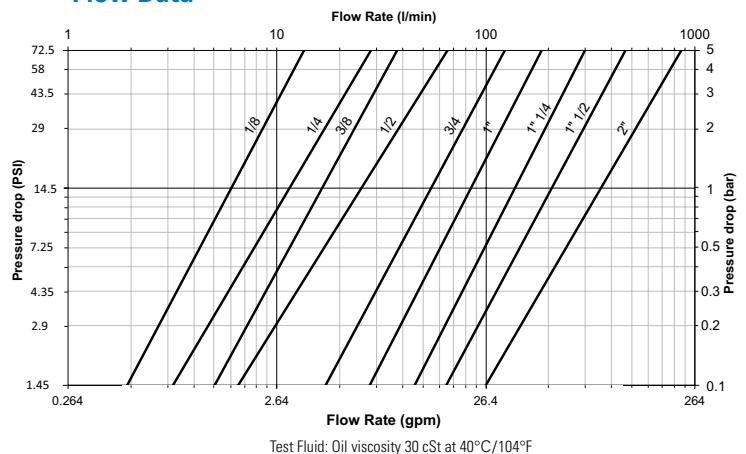

Seal Elastomer Data*

Seal Elastomer	Max. Operation Temperature Range
NBR (Nitrile)	-20°C +100°C/-4°F +212°F
FKM	-20°C +200°C/-4°F +392°F
EPDM (Ethylene-Propylene)**	-40°C +150°C/-40°F +302°F

* For reference only, based on Eaton recommended temperatures.
 ** In accordance with NF L 17-241 or NAS 1613 rev. 5
 Contact Eaton technical support for further information on fluid compatibility.

Applications & Markets

- Automobile
- Agriculture
- Construction
- Oil and Gas
- Railway
- Aeronautics
- Food Processing
- Iron and Steel Industry
- Electronics
- Laboratories
- General Hydraulic Applications

H5000 Series (Steel)

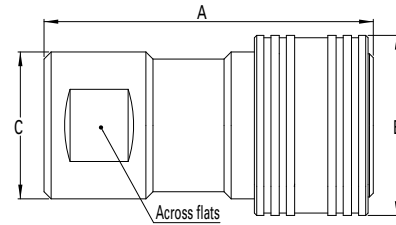

Figure 1

Sockets (Female)

Part Number	FKM	EPDM	Body Size (in)	Nominal Flow Diameter (mm)	Thread Size** (Female)			Fig.	Dimensions								Weight	
					NPT	BSPB	Metric		A (in)	B (in)	C (in)	Across flats (in)	A (mm)	B (mm)	C (mm)	Across flats (mm)	lbs	grams
HA0500100	HA05001V0	HA05001E0	1/8	3.8	-	1/8-28	-	1	1.65	0.94	0.83	0.63	42	24	21	16	0.19	88
HA0520100	HA05201V0	HA05201E0	1/8	3.8	1/8-27	-	-	1	1.65	0.94	0.83	0.63	42	24	21	16	0.19	88
HA0530100	HA05301V0	HA05301E0	1/8	3.8	-	-	M10x100	1	1.65	0.94	0.83	0.63	42	24	21	16	0.19	88
HA0501100	HA05011V0	HA05011E0	1/4	5.7	-	1/4-19	-	1	1.97	1.10	0.94	0.75	50	28	24	19	0.27	122
HA0521100	HA05211V0	HA05211E0	1/4	5.7	1/4-18	-	-	1	1.97	1.10	0.94	0.75	50	28	24	19	0.27	122
HA0531100	HA05311V0	HA05311E0	1/4	5.7	-	-	M14x150	1	1.97	1.10	0.94	0.75	50	28	24	19	0.27	122
HA0502100	HA05021V0	HA05021E0	3/8	7.6	-	3/8-19	-	1	2.32	1.34	1.10	0.90	59	34	28	23	0.43	197
HA0522100	HA05221V0	HA05221E0	3/8	7.6	3/8-18	-	-	1	2.32	1.34	1.10	0.90	59	34	28	23	0.43	197
HA0532100	HA05321V0	HA05321E0	3/8	7.6	-	-	M18x150	1	2.32	1.34	1.10	0.90	59	34	28	23	0.43	197
HA0503100	HA05031V0	HA05031E0	1/2	10.3	-	1/2-14	-	1	2.71	1.50	1.22	1.06	69	38	31	27	0.50	226
HA0523100	HA05231V0	HA05231E0	1/2	10.3	1/2-14	-	-	1	2.71	1.50	1.22	1.06	69	38	31	27	0.50	226
HA0533100	HA05331V0	HA05331E0	1/2	10.3	-	-	M22x150	1	2.71	1.50	1.22	1.06	69	38	31	27	0.50	226
HA0504100	HA05041V0	HA05041E0	3/4	14.2	-	3/4-14	-	1	3.50	1.89	1.57	1.38	89	48	40	35	1.27	577
HA0524100	HA05241V0	HA05241E0	3/4	14.2	3/4-14	-	-	1	3.50	1.89	1.57	1.38	89	48	40	35	1.27	577
HA0534100	HA05341V0	HA05341E0	3/4	14.2	-	-	M27x150	1	3.50	1.89	1.57	1.38	89	48	40	35	1.27	577
HA0505100	HA05051V0	HA05051E0	1	16.5	-	1-11	-	1	3.89	2.05	1.77	1.61	99	52	45	41	1.59	720
HA0525100	HA05251V0	HA05251E0	1	16.5	1-11 1/2	-	-	1	3.89	2.05	1.77	1.61	99	52	45	41	1.59	720
-	HA05061V0	HA05061E0	1 1/4	20.5	-	1 1/4-11	-	1	5.20	2.95	2.44	2.16	132	75	62	55	4.77	2,165
-	HA05071V0	HA05071E0	1 1/2	25.8	-	1 1/2-11	-	1	5.90	3.35	2.95	2.56	150	85	75	65	7.72	3,500
-	HA05091V0	HA05091E0	2	34.7	-	2-11	-	1	6.69	3.82	3.35	2.95	170	97	85	75	10.67	4,840

* Body sizes 1 1/4, 1 1/2 and 2 are supplied with FKM seals as a standard.

** Alternative end connections available upon request.

To obtain connected length of coupling add dimensions A (Fig. 1) and J (Fig. 3) together.

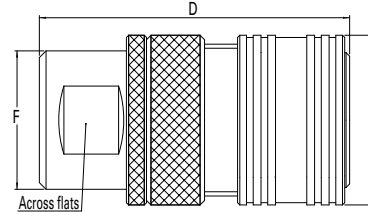

Figure 2

Sockets with Sleeve Lock (Female)

Part Number	FKM	EPDM	Body Size (in)	Nominal Flow Diameter (mm)	Thread Size** (Female)			Fig.	Dimensions								Weight	
					NPT	BSPB	Metric		D (in)	E (in)	F (in)	Across flats (in)	D (mm)	E (mm)	F (mm)	Across flats (mm)	lbs	grams
HA0500300	HA05003V0	HA05003E0	1/8	3.8	-	1/8-28	-	2	1.65	0.94	0.83	0.63	42	24	21	16	0.19	91
HA0520300	HA05203V0	HA05203E0	1/8	3.8	1/8-27	-	-	2	1.65	0.94	0.83	0.63	42	24	21	16	0.19	91
HA0530300	HA05303V0	HA05303E0	1/8	3.8	-	-	M10x100	2	1.65	0.94	0.83	0.63	42	24	21	16	0.19	91
HA0501300	HA05013V0	HA05013E0	1/4	5.7	-	1/4-19	-	2	1.97	1.10	0.94	0.75	50	28	24	19	0.27	134
HA0521300	HA05213V0	HA05213E0	1/4	5.7	1/4-18	-	-	2	1.97	1.10	0.94	0.75	50	28	24	19	0.27	134
HA0531300	HA05313V0	HA05313E0	1/4	5.7	-	-	M14x150	2	1.97	1.10	0.94	0.75	50	28	24	19	0.27	134
HA0502300	HA05023V0	HA05023E0	3/8	7.6	-	3/8-19	-	2	2.32	1.34	1.10	0.90	59	34	28	23	0.43	225
HA0522300	HA05223V0	HA05223E0	3/8	7.6	3/8-18	-	-	2	2.32	1.34	1.10	0.90	59	34	28	23	0.43	225
HA0532300	HA05323V0	HA05323E0	3/8	7.6	-	-	M18x150	2	2.32	1.34	1.10	0.90	59	34	28	23	0.43	225
HA0503300	HA05033V0	HA05033E0	1/2	10.3	-	1/2-14	-	2	2.71	1.50	1.22	1.06	69	38	31	27	0.50	310
HA0523300	HA05233V0	HA05233E0	1/2	10.3	1/2-14	-	-	2	2.71	1.50	1.22	1.06	69	38	31	27	0.50	310
HA0533300	HA05333V0	HA05333E0	1/2	10.3	-	-	M22x150	2	2.71	1.50	1.22	1.06	69	38	31	27	0.50	310
HA0504300	HA05043V0	HA05043E0	3/4	14.2	-	3/4-14	-	2	3.50	1.89	1.57	1.38	89	48	40	35	1.27	665
HA0524300	HA05243V0	HA05243E0	3/4	14.2	3/4-14	-	-	2	3.50	1.89	1.57	1.38	89	48	40	35	1.27	665
HA0534300	HA05343V0	HA05343E0	3/4	14.2	-	-	M27x150	2	3.50	1.89	1.57	1.38	89	48	40	35	1.27	665
HA0505300	HA05053V0	HA05053E0	1	16.5	-	1-11	-	2	3.89	2.05	1.77	1.61	99	52	45	41	1.59	813
HA0525300	HA05253V0	HA05253E0	1	16.5	1-11 1/2	-	-	2	3.89	2.05	1.77	1.61	99	52	45	41	1.59	813
-	HA05063V0	HA05063E0	1 1/4	20.5	-	1 1/4-11	-	2	5.20	2.95	2.44	2.16	132	75	62	55	4.77	2,230
-	HA05073V0	HA05073E0	1 1/2	25.8	-	1 1/2-11	-	2	5.90	3.35	2.95	2.56	150	85	75	65	7.72	3,585
-	HA05093V0	HA05093E0	2	34.7	-	2-11	-	2	6.69	3.82	3.35	2.95	170	97	85	75	10.67	5,658

* Body sizes 1 1/4, 1 1/2 and 2 are supplied with FKM seals as a standard.

** Alternative end connections available upon request.

To obtain connected length of coupling add dimensions D (Fig. 2) and J (Fig. 3) together.

FLUID TRANSFER
AND HYDRAULIC

PNEUMATIC

SPECIAL APPLICATIONS

DIAGNOSTIC

AGRICULTURE

REFRIGERANT

H5000 Series (Steel)

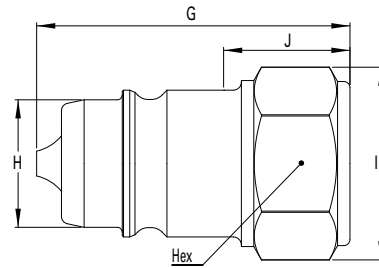

Figure 3

Plugs (Male)

Part Number	Body Size	Nominal Flow Diameter	Thread Size** (Female)			Dimensions										Weight				
			NPT	BSPP	Metric	Fig.	G (in)	H (in)	I (in)	J (in)	Hex (in)	G (mm)	H (mm)	I (mm)	J (mm)	Hex (mm)	lbs	grams		
HA0500200	HA05002V0	HA05002E0	1/8	3.8	-	1/8-28	-	3	1.10	0.43	0.72	0.39	0.63	28	11	18.4	10	16	0.05	23
HA0520200	HA05202V0	HA05202E0	1/8	3.8	-	1/8-27	-	3	1.10	0.43	0.72	0.39	0.63	28	11	18.4	10	16	0.05	23
HA0530200	HA05302V0	HA05302E0	1/8	3.8	-	-	M10x100	3	1.10	0.43	0.72	0.39	0.63	28	11	18.4	10	16	0.05	23
HA0501200	HA05012V0	HA05012E0	1/4	5.7	-	1/4-19	-	3	1.38	0.56	0.86	0.55	0.75	35	14.2	21.8	14	19	0.08	37
HA0521200	HA05212V0	HA05212E0	1/4	5.7	-	1/4-18	-	3	1.38	0.56	0.86	0.55	0.75	35	14.2	21.8	14	19	0.08	37
HA0531200	HA05312V0	HA05312E0	1/4	5.7	-	-	M14x150	3	1.38	0.56	0.86	0.55	0.75	35	14.2	21.8	14	19	0.08	37
HA0502200	HA05022V0	HA05022E0	3/8	7.6	-	3/8-19	-	3	1.65	0.75	1.04	0.7	0.90	42	19	26.4	18	23	0.15	70
HA0522200	HA05222V0	HA05222E0	3/8	7.6	-	3/8-18	-	3	1.65	0.75	1.04	0.7	0.90	42	19	26.4	18	23	0.15	70
HA0532200	HA05322V0	HA05322E0	3/8	7.6	-	-	M18x150	3	1.65	0.75	1.04	0.7	0.90	42	19	26.4	18	23	0.15	70
HA0503200	HA05032V0	HA05032E0	1/2	10.3	-	1/2-14	-	3	1.97	0.81	1.22	0.94	1.06	50	20.6	31	24	27	0.20	92
HA0523200	HA05232V0	HA05232E0	1/2	10.3	-	1/2-14	-	3	1.97	0.81	1.22	0.94	1.06	50	20.6	31	24	27	0.20	92
HA0533200	HA05332V0	HA05332E0	1/2	10.3	-	-	M22x150	3	1.97	0.81	1.22	0.94	1.06	50	20.6	31	24	27	0.20	92
HA0504200	HA05042V0	HA05042E0	3/4	14.2	-	3/4-14	-	3	2.48	1.10	1.58	1.10	1.38	63	27.9	40.2	28	35	0.48	217
HA0524200	HA05242V0	HA05242E0	3/4	14.2	-	3/4-14	-	3	2.48	1.10	1.58	1.10	1.38	63	27.9	40.2	28	35	0.48	217
HA0534200	HA05342V0	HA05342E0	3/4	14.2	-	-	M27x150	3	2.48	1.10	1.58	1.10	1.38	63	27.9	40.2	28	35	0.48	217
HA0505200	HA05052V0	HA05052E0	1	16.5	-	1-11	-	3	2.79	1.27	1.87	1.22	1.61	71	32.4	47.5	31	41	0.63	287
HA0525200	HA05252V0	HA05252E0	1	16.5	-	1-11 1/2	-	3	2.79	1.27	1.87	1.22	1.61	71	32.4	47.5	31	41	0.63	287
-	HA05062V0	HA05062E0	1 1/4	20.5	-	1 1/4-11	-	3	3.82	1.85	2.49	1.89	2.16	97	46.9	63.2	48	55	1.98	900
-	HA05072V0	HA05072E0	1 1/2	25.8	-	1 1/2-11	-	3	4.29	2.20	2.94	2.04	2.56	109	56	74.7	52	65	3.30	1500
-	HA05092V0	HA05092E0	2	34.7	-	2-11	-	3	4.76	2.56	3.30	1.97	2.95	121	65	84	50	75	4.06	1840

* Body sizes 1 1/4, 1 1/2 and 2 are supplied with FKM seals as a standard.

** Alternative end connections available upon request.

To obtain connected length of coupling add dimensions A (Fig. 1) and J (Fig. 3) together for standard version ; add dimensions D (Fig. 2) and J (Fig. 3) together for sleeve lock version.

Dust Plugs and Dust Caps

Body Size (in)	Socket Dust Plug Part Number Anodized Aluminum	Plug Dust Cap Part Number Anodized Aluminum
1/8	HD0510100	HD0510200
1/4	HD0511100	HD0511200
3/8	HD0512100	HD0512200
1/2	HD0513100	HD0513200
3/4	HD0514100	HD0514200
1	HD0515100	HD0515200
1 1/4	HD0516100	HD0516200
1 1/2	HD0517100	HD0517200
2	HD0519100	HD0519200

Socket Dust Plug



Plug Dust Cap



Seal Kit for Servicing Sockets (Female)

Body Size (in)	Seal & Back-up Ring Kit*					
	NBR seals & PTFE back-up rings	Qty	FKM seals & PTFE back-up rings	Qty	EPDM seals & PTFE back-up rings	Qty
1/8	HG 05001 00	50 O-rings + 50 Backup rings	HG 05001 V0	15 O-rings + 15 Backup rings	HG 05001 E0	15 O-rings + 15 Backup rings
1/4	HG 05011 00	50 O-rings + 50 Backup rings	HG 05011 V0	15 O-rings + 15 Backup rings	HG 05011 E0	15 O-rings + 15 Backup rings
3/8	HG 05021 00	50 O-rings + 50 Backup rings	HG 05021 V0	15 O-rings + 15 Backup rings	HG 05021 E0	15 O-rings + 15 Backup rings
1/2	HG 05031 00	50 O-rings + 50 Backup rings	HG 05031 V0	15 O-rings + 15 Backup rings	HG 05031 E0	15 O-rings + 15 Backup rings
3/4	HG 05041 00	50 O-rings + 50 Backup rings	HG 05041 V0	15 O-rings + 15 Backup rings	HG 05041 E0	15 O-rings + 15 Backup rings
1	HG 05051 00	50 O-rings + 50 Backup rings	HG 05051 V0	10 O-rings + 10 Backup rings	HG 05051 E0	10 O-rings + 10 Backup rings
1 1/4	HG 05061 00	15 O-rings + 15 Backup rings	HG 05061 V0	5 O-rings + 5 Backup rings	-	-
1 1/2	HG 05071 00	15 O-rings + 15 Backup rings	-	-	-	-
2	HG 05091 00	15 O-rings + 15 Backup rings	-	-	-	-

*The valve seal is not included in our repair kits

H5000 Series (Brass)



Eaton's H5000 Series brass quick disconnect coupling is a pull to connect double shut-off coupling. It is a general purpose industrial quick disconnect coupling with the original Eaton's Gromelle™ profile. Mainly used in fluid transfer applications where stainless steel is not a requirement, it offers a good alternative for corrosion resistance.

Product Features

- Proprietary profile
- Pull-to-connect with double shut-off valving
- Ball-locking
- Pressure performance
- Optional safety sleeve lock prevents accidental disconnections
- Optional dust caps and plugs (made of anodized aluminum)
- Standard body material: Nickel-plated brass
- Standard seal material: NBR, FKM, EPDM

European Pressure Equipment Directive

All couplings are designed and manufactured under Article 4.3 of the European Pressure Equipment Directive PED 2014/68/EU. Couplings with nominal diameters greater than 25 mm should not be used to convey gases in Group 1 (hazardous).

Group 1 = Hazardous media / Group 2 = Other media

Physical Characteristics

Body Size	Nominal Flow Diameter*	Max. Operating Pressure**		Rated Flow***	Fluid Loss	
		Hazardous and Non hazardous liquids in Group 1&2	Non hazardous Gases in Group 2			
(in)	(mm)	(bar)	(psi)	(lpm)	(gpm)	ml-cc.
1/8	3.8	300	4,350	300	4,350	6.1 1.61 0.4
1/4	5.7	230	3,335	230	3,335	11.6 3.06 1
3/8	7.6	175	2,535	175	2,535	16.7 4.41 2
1/2	10.3	150	2,175	150	2,175	25.5 6.74 2.5
3/4	14.2	125	1,810	125	1,810	55 14.53 5.5
1	16.5	100	1,450	100	1,450	87 22.98 9
1 1/4	20.5	70	1,015	70	1,015	140 36.98 23
1 1/2	25.8	50	725	50	725	208 54.95 36
2	34.7	40	290	28	406	357 94.3 70

* Nominal diameters over 25 mm should not be used to convey gases in Group 1 (PED 2014/68/EU)

** For pulsating pressures when disconnected apply a multiplier of 0.5

*** Indicated values refer to a 1 bar/14.5 psi pressure drop.

Applications & Markets

- Automobile
- Agriculture
- Construction
- Oil and Gas
- Railway
- Aeronautics
- Food Processing
- Iron and Steel Industry
- Electronics
- Laboratories
- General Hydraulic Applications

Flow Data

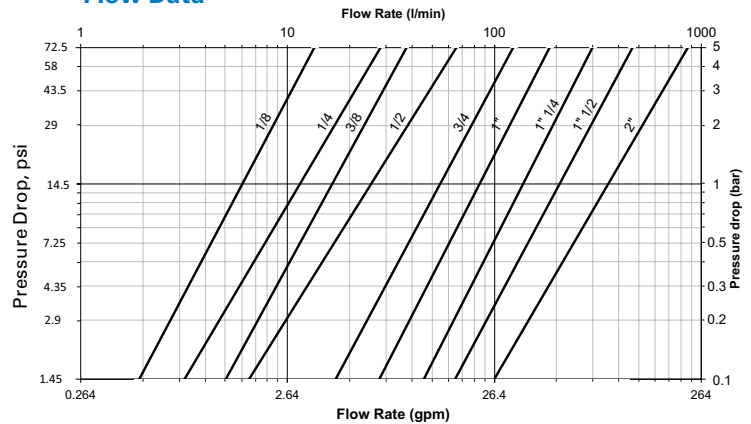

Seal Elastomer Data*

Seal Elastomer	Max. Operation Temperature Range
NBR (Nitrile)	-20°C +100°C/-4°F +212°F
FKM (Fluorocarbon)	-20°C +200°C/-4°F +392°F
EPDM (Ethylene-Propylene)**	-40°C +150°C/-40°F +302°F

* For reference only, based on Eaton recommended temperatures.

** In accordance with NF L 17-241 or NAS 1613 rev. 5

Contact Eaton technical support for further information on fluid compatibility.

H5000 Series (Brass)

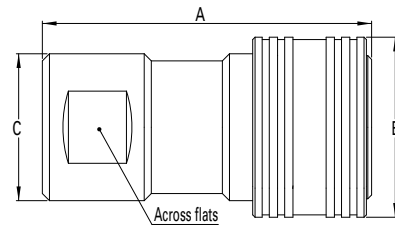

Figure 1

Sockets (Female)

Part Number			Body Size (in)	Nominal Flow Diameter (mm)	Thread Size* (Female)	Fig.	Dimensions							Weight		
NBR	FKM	EPDM					A (in)	B (in)	C (in)	Across flats (in)	A (mm)	B (mm)	C (mm)	Across flats (mm)	lbs	grams
HL0500100	HL05001V0	HL05001E0	1/8	3.8	1/8-28	1	1.65	0.94	0.83	0.63	42	24	21	16	0.21	97
HL0501100	HL05011V0	HL05011E0	1/4	5.7	1/4-19	1	1.97	1.10	0.94	0.75	50	28	24	19	0.30	134
HL0502100	HL05021V0	HL05021E0	3/8	7.6	3/8-19	1	2.32	1.34	1.10	0.90	59	34	28	23	0.48	217
HL0503100	HL05031V0	HL05031E0	1/2	10.3	1/2-14	1	2.71	1.50	1.22	1.06	69	38	31	27	0.55	249
HL0504100	HL05041V0	HL05041E0	3/4	14.2	3/4-14	1	3.50	1.89	1.57	1.38	89	48	40	35	1.40	635
HL0505100	HL05051V0	HL05051E0	1	16.5	1-11	1	3.89	2.05	1.77	1.61	99	52	45	41	1.75	792
HL0506100	HL05061V0	HL05061E0	1 1/4	20.5	1 1/4-11	1	5.20	2.95	2.44	2.16	132	75	62	55	5.25	2,382
HL0507100	HL05071V0	HL05071E0	1 1/2	25.8	1 1/2-11	1	5.90	3.35	2.95	2.56	150	85	75	65	8.49	3,850
HL0509100	HL05091V0	HL05091E0	2	34.7	2-11	1	6.69	3.82	3.35	2.95	170	97	85	75	11.74	5,324

* Alternative end connections available upon request.

To obtain connected length of coupling add dimensions A (Fig. 1) and J (Fig. 3) together.

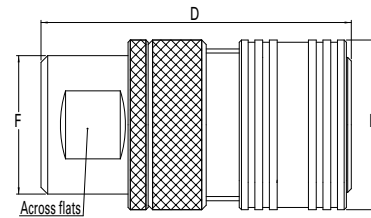

Figure 2

Sockets with Sleeve Lock (Female)

Part Number			Body Size (in)	Nominal Flow Diameter (mm)	Thread Size* (Female)	Fig.	Dimensions							Weight		
NBR	FKM	EPDM					D (in)	E (in)	F (in)	Across flats (in)	D (mm)	E (mm)	F (mm)	Across flats (mm)	lbs	grams
HL0500300	HL05003V0	HL05003E0	1/8	3.8	1/8-28	2	1.65	0.94	0.83	0.63	42	24	21	16	0.22	100
HL0501300	HL05013V0	HL05013E0	1/4	5.7	1/4-19	2	1.97	1.10	0.94	0.75	50	28	24	19	0.33	148
HL0502300	HL05023V0	HL05023E0	3/8	7.6	3/8-19	2	2.32	1.34	1.10	0.90	59	34	28	23	0.55	248
HL0503300	HL05033V0	HL05033E0	1/2	10.3	1/2-14	2	2.71	1.50	1.22	1.06	69	38	31	27	0.75	341
HL0504300	HL05043V0	HL05043E0	3/4	14.2	3/4-14	2	3.50	1.89	1.57	1.38	89	48	40	35	1.61	732
HL0505300	HL05053V0	HL05053E0	1	16.5	1-11	2	3.89	2.05	1.77	1.61	99	52	45	41	1.97	894
HL0506300	HL05063V0	HL05063E0	1 1/4	20.5	1 1/4-11	2	5.20	2.95	2.44	2.16	132	75	62	55	5.41	2,453
HL0507300	HL05073V0	HL05073E0	1 1/2	25.8	1 1/2-11	2	5.90	3.35	2.95	2.56	150	85	75	65	8.69	3,944
HL0509300	HL05093V0	HL05093E0	2	34.7	2-11	2	6.69	3.82	3.35	2.95	170	97	85	75	13.72	6,224

* Alternative end connections available upon request.

To obtain connected length of coupling add dimensions D (Fig. 2) and J (Fig. 3) together.

H5000 Series (Brass)

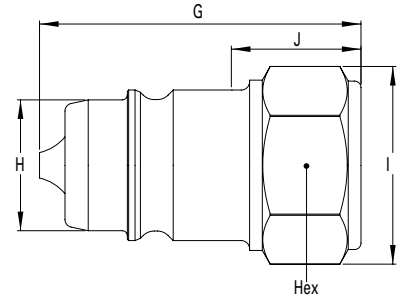

Figure 3

Plugs (Male)

Part Number			Body Size (in)	Nominal Flow Diameter (mm)	Thread Size** (Female)	Fig.	Dimensions										Weight	
NBR*	FKM	EPDM					G (in)	H (in)	I (in)	J (in)	Hex (in)	G (mm)	H (mm)	I (mm)	J (mm)	Hex (mm)	lbs	grams
HL0500200	HL05002V0	HL05002E0	1/8	3.8	1/8-28	3	1.1	0.43	0.72	0.39	0.63	28	11	18.4	10	16	0.06	26
HL0501200	HL05012V0	HL05012E0	1/4	5.7	1/4-19	3	1.38	0.56	0.86	0.55	0.75	35	14.2	21.8	14	19	0.09	41
HL0502200	HL05022V0	HL05022E0	3/8	7.6	3/8-19	3	1.65	0.75	1.04	0.70	0.90	42	19	26.4	18	23	0.17	77
HL0503200	HL05032V0	HL05032E0	1/2	10.3	1/2-14	3	1.97	0.81	1.22	0.94	1.06	50	20.6	31	24	27	0.22	101
HL0504200	HL05042V0	HL05042E0	3/4	14.2	3/4-14	3	2.48	1.10	1.58	1.10	1.38	63	27.9	40.2	28	35	0.53	239
HL0505200	HL05052V0	HL05052E0	1	16.5	1-11	3	2.79	1.27	1.87	1.22	1.61	71	32.4	47.5	31	41	0.70	316
-	HL05062V0	HL05062E0	1 1/4	20.5	1 1/4-11	3	3.82	1.85	2.49	1.89	2.16	97	46.9	63.2	48	55	2.18	990
-	HL05072V0	HL05072E0	1 1/2	25.8	1 1/2-11	3	4.29	2.20	2.94	2.04	2.56	109	56	74.7	52	65	3.64	1650
-	HL05092V0	HL05092E0	2	34.7	2-11	3	4.76	2.56	3.30	1.97	2.95	121	65	84	50	75	4.46	2024

* Body sizes 1 1/4, 1 1/2 and 2 are supplied with FKM seals as a standard.

** Alternative end connections available upon request.

To obtain connected length of coupling add dimensions A (Fig. 1) and J (Fig. 3) together for standard version; add dimensions D (Fig. 2) and J (Fig. 3) together for sleeve lock version

Dust Plugs and Dust Caps

Body Size (in)	Socket Dust Plug Part Number Anodized Aluminum	Plug Dust Cap Part Number Anodized Aluminum
1/8	HD0510100	HD0510200
1/4	HD0511100	HD0511200
3/8	HD0512100	HD0512200
1/2	HD0513100	HD0513200
3/4	HD0514100	HD0514200
1	HD0515100	HD0515200
1 1/4	HD0516100	HD0516200
1 1/2	HD0517100	HD0517200
2	HD0519100	HD0519200

Socket Dust Plug



Plug Dust Cap



Seal Kit for Servicing Sockets (Female)

Body Size (in)	Seal & Back-up Ring Kit*					
	NBR seals & PTFE back-up rings	Qty	FKM seals & PTFE back-up rings	Qty	EPDM seals & PTFE back-up rings	Qty
1/8	HG 05001 00	50 O-rings + 50 Backup rings	HG 05001 V0	15 O-rings + 15 Backup rings	HG 05001 E0	15 O-rings + 15 Backup rings
1/4	HG 05011 00	50 O-rings + 50 Backup rings	HG 05011 V0	15 O-rings + 15 Backup rings	HG 05011 E0	15 O-rings + 15 Backup rings
3/8	HG 05021 00	50 O-rings + 50 Backup rings	HG 05021 V0	15 O-rings + 15 Backup rings	HG 05021 E0	15 O-rings + 15 Backup rings
1/2	HG 05031 00	50 O-rings + 50 Backup rings	HG 05031 V0	15 O-rings + 15 Backup rings	HG 05031 E0	15 O-rings + 15 Backup rings
3/4	HG 05041 00	50 O-rings + 50 Backup rings	HG 05041 V0	15 O-rings + 15 Backup rings	HG 05041 E0	15 O-rings + 15 Backup rings
1	HG 05051 00	50 O-rings + 50 Backup rings	HG 05051 V0	10 O-rings + 10 Backup rings	HG 05051 E0	10 O-rings + 10 Backup rings
1 1/4	HG 05061 00	15 O-rings + 15 Backup rings	HG 05061 V0	5 O-rings + 5 Backup rings	-	-
1 1/2	HG 05071 00	15 O-rings + 15 Backup rings	-	-	-	-
2	HG 05091 00	15 O-rings + 15 Backup rings	-	-	-	-

*The valve seal is not included in our repair kits

FLUID TRANSFER
AND HYDRAULIC

PNEUMATIC

SPECIAL APPLICATIONS

DIAGNOSTIC

AGRICULTURE

REFRIGERANT

H5000 Series (Stainless Steel)



Eaton's H5000 Series stainless steel quick disconnect coupling is a pull to connect double shut-off coupling. It is a general purpose industrial coupling with the original Eaton's Gromelle™ profile. It is mainly used in fluid transfer applications and provides excellent corrosion resistance.

Product Features

- Proprietary profile
- Pull-to-connect with double shut-off valving
- Ball-locking
- Optional safety sleeve lock prevents accidental disconnections
- Optional dust caps and plugs (made of anodized aluminum)
- Pressure performance
- Standard body material: AISI 316L Stainless steel
- Standard seal material: FKM, EPDM

European Pressure Equipment Directive

Couplings with nominal diameters up to and including 25 mm are designed and manufactured under Article 4.3 of the European Pressure Equipment Directive PED 2014/68/EU. Couplings with nominal diameters greater than 25 mm are designed and manufactured in accordance with the stipulations of Module A of the European Pressure Equipment Directive PED 2014/68/EU. They should not be used to convey unstable gases.

Group 1 = Hazardous media / Group 2 = Other media

Physical Characteristics

Body Size (in)	Nominal Flow Diameter (mm)	Max. Operating Pressure*				Rated Flow**		Fluid Loss ml-cc.
		Non hazardous liquids & gases Group 2		Hazardous liquids & gases Group 1		(lpm)	(gpm)	
		(bar)	(psi)	(bar)	(psi)			
1/8	3.8	300	4,350	300	4,350	6.1	1.61	0.4
1/4	5.7	230	3,335	230	3,335	11.6	3.06	1
3/8	7.6	175	2,535	175	2,535	16.7	4.41	2
1/2	10.3	150	2,175	150	2,175	25.5	6.74	2.5
3/4	14.2	125	1,810	125	1,810	55	14.53	5.5
1	16.5	100	1,450	100	1,450	87	22.98	9
1 1/4	20.5	100	1,450	100	1,450	140	36.98	23
1 1/2	25.8	75	1,085	28	550	208	54.95	36
2	34.7	40	580	38	405	357	94.30	70

* For pulsating pressures when disconnected apply a multiplier of 0.5

** Indicated values refer to a 1 bar/14.5 psi pressure drop.

Applications & Markets

- Automobile
- Agriculture
- Construction
- Oil and Gas
- Railway
- Aeronautics
- Food Processing
- Iron and Steel Industry
- Electronics
- Laboratories
- General Hydraulic Applications

Flow Data

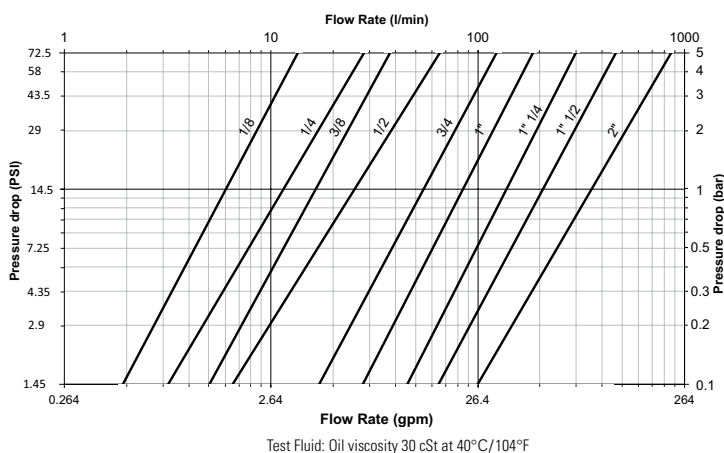

Seal Elastomer Data*

Seal Elastomer	Max. Operation Temperature Range
FKM	-20°C +200°C/-4°F +392°F
EPDM (Ethylene-Propylene)**	-40°C +150°C/-40°F +302°F

* For reference only, based on Eaton recommended temperatures.

** In accordance with NF L 17-241 or NAS 1613 rev. 5

Contact Eaton technical support for further information on fluid compatibility.

H5000 Series (Stainless Steel)

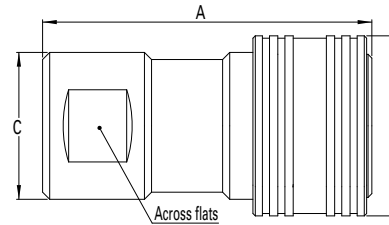

Figure 1

Sockets (Female)

Part Number	FKM	EPDM	Body Size (in)	Nominal Flow Diameter (mm)	Thread Size* (Female)		Fig.	Dimensions							Weight		
					NPT	BSPP		A (in)	B (in)	C (in)	Across flats (in)	A (mm)	B (mm)	C (mm)	Across flats (mm)	lbs	grams
HZ05001V0		HZ05001E0	1/8	3.8	-	1/8-28	1	1.65	0.94	0.83	0.63	42	24	21	16	0.19	88
HZ05201V0		HZ05201E0	1/8	3.8	1/8-27	-	1	1.65	0.94	0.83	0.63	42	24	21	16	0.19	88
HZ05011V0		HZ05011E0	1/4	5.7	-	1/4-19	1	1.97	1.10	0.94	0.75	50	28	24	19	0.27	122
HZ05211V0		HZ05211E0	1/4	5.7	1/4-18	-	1	1.97	1.10	0.94	0.75	50	28	24	19	0.27	122
HZ05021V0		HZ05021E0	3/8	7.6	-	3/8-19	1	2.32	1.34	1.10	0.90	59	34	28	23	0.43	197
HZ05221V0		HZ05221E0	3/8	7.6	3/8-18	-	1	2.32	1.34	1.10	0.90	59	34	28	23	0.43	197
HZ05031V0		HZ05031E0	1/2	10.3	-	1/2-14	1	2.71	1.50	1.22	1.06	69	38	31	27	0.50	226
HZ05231V0		HZ05231E0	1/2	10.3	1/2-14	-	1	2.71	1.50	1.22	1.06	69	38	31	27	0.50	226
HZ05041V0		HZ05041E0	3/4	14.2	-	3/4-14	1	3.50	1.89	1.57	1.38	89	48	40	35	1.27	577
HZ05241V0		HZ05241E0	3/4	14.2	3/4-14	-	1	3.50	1.89	1.57	1.38	89	48	40	35	1.27	577
HZ05051V0		HZ05051E0	1	16.5	-	1-11	1	3.89	2.05	1.77	1.61	99	52	45	41	1.59	720
HZ05251V0		HZ05251E0	1	16.5	1-11 1/2	-	1	3.89	2.05	1.77	1.61	99	52	45	41	1.59	720
HZ05061V0		HZ05061E0	1 1/4	20.5	-	1 1/4-11	1	5.20	2.95	2.44	2.16	132	75	62	55	4.77	2,165
HZ05071V0		HZ05071E0	1 1/2	25.8	-	1 1/2-11	1	5.90	3.35	2.95	2.56	150	85	75	65	7.72	3,500
HZ05091V0		HZ05091E0	2	34.7	-	2-11	1	6.69	3.82	3.35	2.95	170	97	85	75	10.67	4,840

* Alternative end connections available upon request.

To obtain connected length of coupling add dimensions A (Fig. 1) and J (Fig. 3) together.

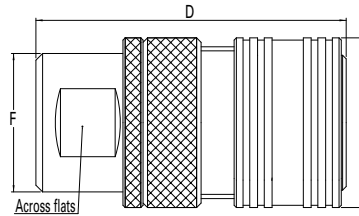

Figure 2

Sockets with Sleeve Lock (Female)

Part Number	FKM	EPDM	Body Size (in)	Nominal Flow Diameter (mm)	Thread Size* (Female)	Fig.	Dimensions							Weight		
							D (in)	E (in)	F (in)	Across flats (in)	D (mm)	E (mm)	F (mm)	Across flats (mm)	lbs	grams
HZ05003V0		HZ05003E0	1/8	3.8	1/8-28	2	1.65	0.94	0.83	0.63	42	24	21	16	0.19	91
HZ05013V0		HZ05013E0	1/4	5.7	1/4-19	2	1.97	1.10	0.94	0.75	50	28	24	19	0.27	134
HZ05023V0		HZ05023E0	3/8	7.6	3/8-19	2	2.32	1.34	1.10	0.90	59	34	28	23	0.43	225
HZ05033V0		HZ05033E0	1/2	10.3	1/2-14	2	2.71	1.50	1.22	1.06	69	38	31	27	0.50	310
HZ05043V0		HZ05043E0	3/4	14.2	3/4-14	2	3.50	1.89	1.57	1.38	89	48	40	35	1.27	665
HZ05053V0		HZ05053E0	1	16.5	1-11	2	3.89	2.05	1.77	1.61	99	52	45	41	1.59	813
HZ05063V0		HZ05063E0	1 1/4	20.5	1 1/4-11	2	5.20	2.95	2.44	2.16	132	75	62	55	4.77	2,230
HZ05073V0		HZ05073E0	1 1/2	25.8	1 1/2-11	2	5.90	3.35	2.95	2.56	150	85	75	65	7.72	3,585
HZ05093V0		HZ05093E0	2	34.7	2-11	2	6.69	3.82	3.35	2.95	170	97	85	75	10.67	5,658

* Alternative end connections available upon request.

To obtain connected length of coupling add dimensions D (Fig. 2) and J (Fig. 3) together.

FLUID TRANSFER
AND HYDRAULIC

PNEUMATIC

SPECIAL APPLICATIONS

DIAGNOSTIC

AGRICULTURE

REFRIGERANT

H5000 Series (Stainless Steel)

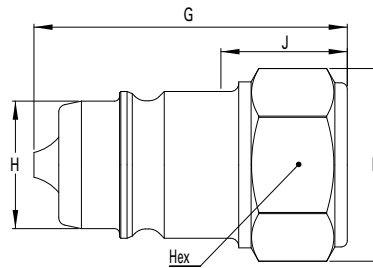

Figure 3

Plugs (Male)

Part Number	Body Size	Nominal Flow Diameter	Thread Size* (Female)		Fig.	Dimensions										Weight		
			NPT	BSPP		G (in)	H (in)	I (in)	J (in)	Hex (in)	G (mm)	H (mm)	I (mm)	J (mm)	Hex (mm)	lbs	grams	
HZ05002V0	HZ05002E0	1/8	3.8	-	1/8-28	3	1.10	0.43	0.72	0.39	0.63	28	11	18.4	10	16	0.05	23
HZ05202V0	HZ05202E0	1/8	3.8	1/8-27	-	3	1.10	0.43	0.72	0.39	0.63	28	11	18.4	10	16	0.05	23
HZ05012V0	HZ05012E0	1/4	5.7	-	1/4-19	3	1.38	0.56	0.86	0.55	0.75	35	14.2	21.8	14	19	0.08	37
HZ05212V0	HZ05212E0	1/4	5.7	1/4-18	-	3	1.38	0.56	0.86	0.55	0.75	35	14.2	21.8	14	19	0.08	37
HZ05022V0	HZ05022E0	3/8	7.6	-	3/8-19	3	1.65	0.75	1.04	0.70	0.90	42	19	26.4	18	23	0.15	70
HZ05222V0	HZ05222E0	3/8	7.6	3/8-18	-	3	1.65	0.75	1.04	0.70	0.90	42	19	26.4	18	23	0.15	70
HZ05032V0	HZ05032E0	1/2	10.3	-	1/2-14	3	1.97	0.81	1.22	0.94	1.06	50	20.6	31	24	27	0.20	92
HZ05232V0	HZ05232E0	1/2	10.3	1/2-14	-	3	1.97	0.81	1.22	0.94	1.06	50	20.6	31	24	27	0.20	92
HZ05042V0	HZ05042E0	3/4	14.2	-	3/4-14	3	2.48	1.10	1.58	1.10	1.38	63	27.9	40.2	28	35	0.48	217
HZ05242V0	HZ05242E0	3/4	14.2	3/4-14	-	3	2.48	1.10	1.58	1.10	1.38	63	27.9	40.2	28	35	0.48	217
HZ05052V0	HZ05052E0	1	16.5	-	1-11	3	2.79	1.27	1.87	1.22	1.61	71	32.4	47.5	31	41	0.63	287
HZ05252V0	HZ05252E0	1	16.5	1-11 1/2	-	3	2.79	1.27	1.87	1.22	1.61	71	32.4	47.5	31	41	0.63	287
HZ05062V0	HZ05062E0	1 1/4	20.5	-	1 1/4-11	3	3.82	1.85	2.49	1.89	2.16	97	46.9	63.2	48	55	1.98	900
HZ05072V0	HZ05072E0	1 1/2	25.8	-	1 1/2-11	3	4.29	2.20	2.94	2.04	2.56	109	56	74.7	52	65	3.30	1500
HZ05092V0	HZ05092E0	2	34.7	-	2-11	3	4.76	2.56	3.30	1.97	2.95	121	65	84	50	75	4.06	1840

* Alternative end connections available upon request.

To obtain connected length of coupling add dimensions A (Fig. 1) and J (Fig. 3) together for standard version; add Dimensions D (Fig. 2) and J (Fig. 3) together for sleeve lock version

Dust Plugs and Dust Caps

Body Size (in)	Socket Dust Plug Part Number Anodized Aluminum	Plug Dust Cap Part Number Anodized Aluminum
1/8	HD0510100	HD0510200
1/4	HD0511100	HD0511200
3/8	HD0512100	HD0512200
1/2	HD0513100	HD0513200
3/4	HD0514100	HD0514200
1	HD0515100	HD0515200
1 1/4	HD0516100	HD0516200
1 1/2	HD0517100	HD0517200
2	HD0519100	HD0519200

Socket Dust Plug



Plug Dust Cap

Seal Kit for Servicing Sockets (Female)

Body Size (in)	Seal & Back-up Ring Kit*					
	NBR seals & PTFE back-up rings	Qty	FKM seals & PTFE back-up rings	Qty	EPDM seals & PTFE back-up rings	Qty
1/8	HG 05001 00	50 O-rings + 50 Backup rings	HG 05001 V0	15 O-rings + 15 Backup rings	HG 05001 E0	15 O-rings + 15 Backup rings
1/4	HG 05011 00	50 O-rings + 50 Backup rings	HG 05011 V0	15 O-rings + 15 Backup rings	HG 05011 E0	15 O-rings + 15 Backup rings
3/8	HG 05021 00	50 O-rings + 50 Backup rings	HG 05021 V0	15 O-rings + 15 Backup rings	HG 05021 E0	15 O-rings + 15 Backup rings
1/2	HG 05031 00	50 O-rings + 50 Backup rings	HG 05031 V0	15 O-rings + 15 Backup rings	HG 05031 E0	15 O-rings + 15 Backup rings
3/4	HG 05041 00	50 O-rings + 50 Backup rings	HG 05041 V0	15 O-rings + 15 Backup rings	HG 05041 E0	15 O-rings + 15 Backup rings
1	HG 05051 00	50 O-rings + 50 Backup rings	HG 05051 V0	10 O-rings + 10 Backup rings	HG 05051 E0	10 O-rings + 10 Backup rings
1 1/4	HG 05061 00	15 O-rings + 15 Backup rings	HG 05061 V0	5 O-rings + 5 Backup rings	-	-
1 1/2	HG 05071 00	15 O-rings + 15 Backup rings	-	-	-	-
2	HG 05091 00	15 O-rings + 15 Backup rings	-	-	-	-

*The valve seal is not included in our repair kits

FF Series (Steel) ISO 16028 Interchange



Eaton's FF Series flat face is specifically designed for those applications where quick and easy connections and no-spill performance are essential. The FF Series is ideal for use when global interchangeability with other manufacturers is important and is available in sizes from 1/4" through 2" to best meet your specific size requirements.

Product Features

- Meets or exceeds the ISO 16028 standard
- Push-to-connect
- Standard sleeve lock prevents accidental disconnection
- Color identification rings available to help prevent crossing of lines
- Standard Material: High-resistant carbon steel with Guardian Seal™ plating, a whole new level of corrosion resistance with minimum 720 hours RR protection
- Guardian Seal™ plating:
 - Nickel-free
 - Solvent-free
 - Meets Global RoHS, ELV and REACH requirements
- Standard Seal Material: NBR+AU
- Available seal options: NBR+AU, FKM, EPDM, HNBR (upon request)

Physical Characteristics

ISO Size* (mm)	Coupling Size (in)	Maximum Operating Pressure						Minimum Burst Pressure						Rated Flow** (lpm) (gpm)	Fluid Loss ml-cc.	Air Inclusion ml-cc.	Force to Connect		
		Connected***		Plug/ Male Half		Socket/ Female Half		Connected		Plug/ Male Half		Socket/ Female Half					N	Lbs	
6.3	1/4	400	5,800	400	5,800	400	5,800	1,400	20,300	1,400	20,300	1,400	20,300	18	4.8	0.004	0.007	80	18.0
10.0	3/8	400	5,800	400	5,800	400	5,800	1,400	20,300	1,400	20,300	1,400	20,300	40	10.6	0.006	0.010	140	31.5
12.5	1/2	400	5,800	400	5,800	400	5,800	1,400	20,300	1,400	20,300	1,400	20,300	77	20.3	0.012	0.013	195	43.8
16.0	5/8	400	5,800	400	5,800	400	5,800	1,400	20,300	1,400	20,300	1,400	20,300	82	21.7	0.016	0.030	205	46.1
19.0	3/4	400	5,800	400	5,800	400	5,800	1,300	18,850	1,300	18,850	1,400	20,300	114	30.1	0.034	0.015	215	48.3
25.0	1	400	5,800	400	5,800	400	5,800	1,260	18,270	1,260	18,270	1,260	18,270	184	48.6	0.032	0.033	260	58.5
-	1 1/4	300	4,350	300	4,350	300	4,350	900	13,050	900	13,050	900	13,050	260	68.7	0.170	0.053	200	45.0
-	1 1/2	300	4,350	300	4,350	270	3,915	900	13,050	900	13,050	810	11,745	450	118.9	0.265	0.445	385	86.6
-	2	300	4,350	300	4,350	225	3,260	900	13,050	900	13,050	675	9,790	700	184.9	0.390	0.260	375	84.3

* The ISO size corresponds to the internal diameter of the hose or the external diameter of the rigid tube (as defined in ISO 4397 Standard)
 ** Indicated values refer to a 1 bar/14.5 psi pressure drop
 *** 400 bar for static, steady or non-pulsed applications, 350 bar for ISO pressure rating for dynamic applications with moderate hydraulic shock

Applications & Markets

- Hydraulic and Fluid Transfer
- Construction Equipment
- Agricultural Equipment
- Utility Vehicles
- On-Highway Vehicles
- Stationary In-plant Hydraulics and Fluid Transfer
- Interchangeable with HTMA couplings in the 3/8" size

European Pressure Equipment Directive

All couplings are designed and manufactured under Article 4.3 of the European Pressure Equipment Directive PED 2014/68/EU. Couplings with nominal diameters greater than 25 mm should not be used to convey gases in Group 1 (hazardous).

Flow Data

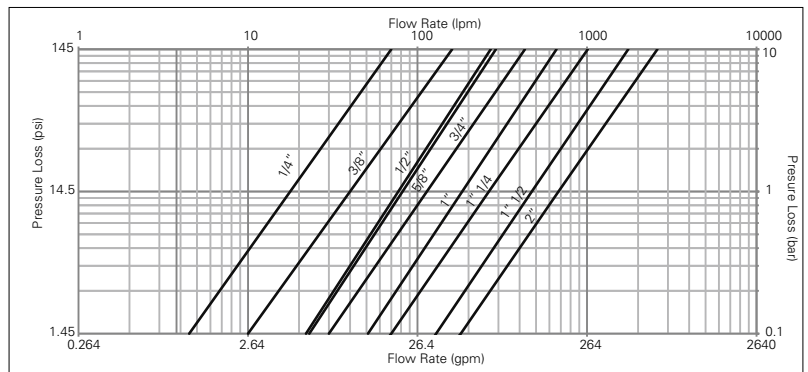

Seal Elastomer Data*

Seal Elastomer	P/N Code	ISO Size (6FF, 10FF, 12FF, 16FF, 19FF and 25FF) Maximum Operation Temperature Range	Non-ISO Size (32FF, 50FF and 50FF) Maximum Operation Temperature Range
NBR (Nitrile) + AU (Polyurethane)		-25°C +100°C/-13°F +212°F	-20°C +100°C/-4°F +212°F
FKM	-143	-20°C +200°C/-4°F +392°F	-15°C +180°C/+5°F +356°F
EPDM (Ethylene-Propylene)	-192	-40°C +150°C/-40°F +302°F	on request
HNBR	-507	-32°C +150°C/-25°F +302°F	on request
Kalrez® 6375	-242	-20°C +275°C/-4°F +527°F	on request
Generic FFKM (Perfluorocarbon)	-503	-15°C +275°C/+5°F +527°F	on request

* For reference only, based on Eaton recommended temperatures. Contact Eaton technical support for further information on fluid compatibility

Maximum Operating Pressure

Coupling Size (in)	Nominal Flow Diameter	Non hazardous liquids Group 2		Non hazardous gases Group 2		Hazardous liquids Group 1	
		Plug & Connected	Socket	Plug & Connected	Socket	Plug & Connected	Socket
1 1/2	30.1	300	4350	270	3915	66	955
2	39.2	300	4350	225	3260	50	725

* Nominal diameters over 25mm should not be used to convey gases in group 1 (PED 2014/68/EU)

FF Series (Steel) ISO 16028 Interchange

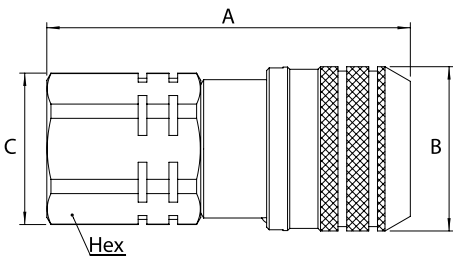

ISO 6149-1
15° + metric thread

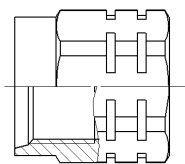

SAE J 1926-1
15° + UN/UNF thread

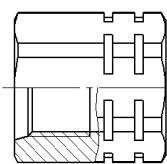

EATON S013A
15° + BSPP thread

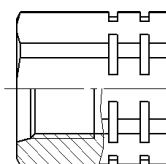

Figure 1

Sockets (Female)

Part Number	Body Size (in)	ISO Size (mm)	Nominal Flow Diameter (mm)	Thread Size* (Female)					Fig.	Dimensions					Weight				
				NPT	BSPP	ISO 6149-1	SAE J 1926-1	Eaton S013A		A (in)	B (in)	C (in)	Hex (in)	A (mm)	B (mm)	C (mm)	Hex (mm)	lbs	grams
NBR-AU																			
6FFS25	¼	6.3	6	¼ 18f					1	2.13	1.06	0.94	0.87	54	27	24	22	-	-
6FFS25BS	¼	6.3	6	¼-19					1	2.13	1.06	0.94	0.87	54	27	24	22	-	-
6FFS25FG	¼	6.3	6					G ¼	1	2.13	1.06	0.94	0.87	54	27	24	22	0.32	143
6FFS56UN	¼	6.3	6				¾ 18f UNF		1	2.17	1.06	0.94	0.87	55	27	24	22	-	-
10FFS16FMET	¾	10	8.6			M16x1.5			1	2.67	1.26	1.16	1.06	67.8	32	29.5	27	-	-
10FFS37	¾	10	8.6	¾ 18f					1	2.67	1.26	1.16	1.06	67.8	32	29.5	27	-	-
10FFS37BS	¾	10	8.6	¾-19					1	2.67	1.26	1.16	1.06	67.8	32	29.5	27	-	-
10FFS37FG	¾	10	8.6					G ¾	1	2.67	1.26	1.16	1.06	67.8	32	29.5	27	0.56	255
10FFS50	¾	10	8.6	½ 14f					1	2.79	1.26	1.16	1.06	70.8	32	29.5	27	-	-
10FFS50BS	¾	10	8.6	½-14					1	2.79	1.26	1.16	1.06	70.8	32	29.5	27	-	-
10FFS50FG	¾	10	8.6					G ½	1	2.79	1.26	1.16	1.06	70.8	32	29.5	27	0.55	251
10FFS56UN	¾	10	8.6			¾ 18f UNF			1	2.79	1.26	1.16	1.06	70.8	32	29.5	27	-	-
10FFS75UN	¾	10	8.6			¾ 16f UNF			1	2.79	1.26	1.16	1.06	70.8	32	29.5	27	-	-
10FFS87UN	¾	10	8.6			¾ 14f UNF			1	2.91	1.26	1.30	1.18	73.8	32	33	30	-	-
12FFS106UN	½	12.5	11			1 ¼ 12F UN			1	3.50	1.50	1.56	1.42	89	38.2	39.5	36	-	-
12FFS50	½	12.5	11	½ 14f					1	3.27	1.50	1.56	1.42	83	38.2	39.5	36	-	-
12FFS50BS	½	12.5	11	½-14					1	3.27	1.50	1.56	1.42	83	38.2	39.5	36	-	-
12FFS50FG	½	12.5	11					G ½	1	3.27	1.50	1.56	1.42	83	38.2	39.5	36	1.1	498
12FFS75	½	12.5	11	¾ 14f					1	3.39	1.50	1.56	1.42	86	38.2	39.5	36	-	-
12FFS75BS	½	12.5	11	¾-14					1	3.39	1.50	1.56	1.42	86	38.2	39.5	36	-	-
12FFS75FG	½	12.5	11					G ¾	1	3.39	1.50	1.56	1.42	86	38.2	39.5	36	1.08	488
12FFS75UN	½	12.5	11			¾ 16f UNF			1	3.27	1.50	1.56	1.42	83	38.2	39.5	36	-	-
12FFS87UN	½	12.5	11			¾ 14f UNF			1	3.39	1.50	1.56	1.42	86	38.2	39.5	36	-	-
16FFS106UN	¾	16	13			1 ½ 12F UN			1	3.50	1.66	1.56	1.42	89	42.2	39.5	36	-	-
16FFS50	¾	16	13	½ 14f					1	3.27	1.66	1.56	1.42	83	42.2	39.5	36	-	-
16FFS50BS	¾	16	13	½-14					1	3.27	1.66	1.56	1.42	83	42.2	39.5	36	-	-
16FFS75	¾	16	13	¾ 14f					1	3.39	1.66	1.56	1.42	86	42.2	39.5	36	-	-
16FFS75BS	¾	16	13	¾-14					1	3.39	1.66	1.56	1.42	86	42.2	39.5	36	-	-
16FFS75FG	¾	16	13					G ¾	1	3.39	1.66	1.56	1.42	86	42.2	39.5	36	1.20	548
16FFS75UN	¾	16	13			¾ 16f UNF			1	3.27	1.66	1.56	1.42	83	42.2	39.5	36	-	-
16FFS87UN	¾	16	13			¾ 14f UNF			1	3.39	1.66	1.56	1.42	86	42.2	39.5	36	-	-
19FFS100	¾	19	15	1 11,5f					1	3.80	1.82	1.81	1.65	96.6	46.2	46	42	-	-
19FFS100BS	¾	19	15	1-11					1	3.80	1.82	1.81	1.65	96.6	46.2	46	42	-	-
19FFS100FG	¾	19	15					G 1	1	3.80	1.82	1.81	1.65	96.6	46.2	46	42	1.62	737
19FFS106UN	¾	19	15			1 ½ 12F UN			1	3.80	1.82	1.81	1.65	96.6	46.2	46	42	-	-
19FFS131UN	¾	19	15			1 ½ 12F UN			1	3.80	1.82	1.81	1.65	96.6	46.2	46	42	-	-
19FFS75	¾	19	15	¾ 14f					1	3.80	1.82	1.81	1.65	96.6	46.2	46	42	-	-
19FFS75BS	¾	19	15	¾-14					1	3.80	1.82	1.81	1.65	96.6	46.2	46	42	-	-
25FFS100	1	25	18	1 11,5f					1	4.07	2.17	2.36	2.17	103.5	55.2	60	55	-	-
25FFS100BS	1	25	18	1-11					1	4.07	2.17	2.36	2.17	103.5	55.2	60	55	-	-
25FFS125	1	25	18	1 ¼ 11,5f					1	4.07	2.17	2.36	2.17	103.5	55.2	60	55	-	-
25FFS125BS	1	25	18	1 ¼-11					1	4.07	2.17	2.36	2.17	103.5	55.2	60	55	-	-
25FFS125FG	1	25	18					G 1 ¼	1	4.07	2.17	2.36	2.17	103.5	55.2	60	55	2.74	1246
25FFS131UN	1	25	18			1 ½ 12F UN			1	4.07	2.17	2.36	2.17	103.5	55.2	60	55	2.77	126
25FFS162UN	1	25	18			1 ½ 12F UN			1	4.07	2.17	2.36	2.17	103.5	55.2	60	55	-	-
32FFS125	1 ¼	-	22.1	1 ¼-11,5					1	4.93	2.55	2.36	2.17	125.2	64.8	60	55	4.22	1915
32FFS125BS	1 ¼	-	22.1	1 ¼-11					1	4.93	2.55	2.36	2.17	125.2	64.8	60	55	4.18	1897
32FFS162UN	1 ¼	-	22.1			1 ½ 12 UN			1	4.93	2.55	2.36	2.17	125.2	64.8	60	55	4.16	1894
40FFS150	1 ½	-	30.1	1 ½-11,5					1	5.01	3.13	2.76	2.56	127.4	79.5	70	65	6.16	2796
40FFS150BS	1 ½	-	30.1	1 ½-11					1	5.01	3.13	2.76	2.56	127.4	79.5	70	65	6.13	2781
40FFS150FG	1 ½	-	30.1					G 1 ½	1	5.01	3.13	2.76	2.56	127.4	79.5	70	65	6.12	2775
40FFS187UN	1 ½	-	30.1			1 ½ 12 UN			1	5.01	3.13	2.76	2.56	127.4	79.5	70	65	6.10	2767
50FFS200	2	-	39.2	2-11,5					1	6.17	3.84	3.46	3.15	156.8	97.5	87.8	80	10.87	4931
50FFS200BS	2	-	39.2	2-11					1	6.17	3.84	3.46	3.15	156.8	97.5	87.8	80	10.82	4908
50FFS250UN	2	-	39.2			2 ½ 12 UN			1	6.17	3.84	3.46	3.15	156.8	97.5	87.8	80	10.64	4825

*Alternative end connections available upon request.
To obtain connected length of coupling, add dimensions A (Fig. 1 or Fig. 2) and G (Fig. 3 or 4) together.

FF Series (Steel) ISO 16028 Interchange

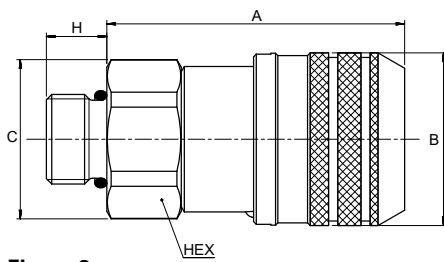
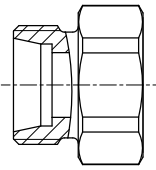
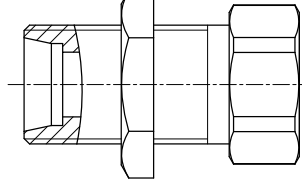

Figure 2

ISO 8434-1
Metric thread



ISO 8434-1 + Bulkhead
Metric thread



SAE J 1926-2
UN/UNF thread

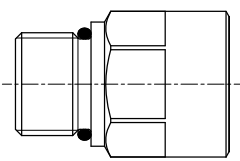

Sockets (Female)

Part Number	Body Size	ISO Size	Nominal Flow Diameter	Thread Size*(Male)		Fig.	Dimensions										Weight	
				ISO 8434-1	SAE J 1926-2		A (in)	B (in)	C (in)	H (in.)	Hex (in)	A (mm)	B (mm)	C (mm)	H (mm)	Hex (mm)	lbs	grams
6FFS10LBH	¼	6.3	6	10L - M16x1,5 + bulkhead		2	1.65	1.06	0.94	1.38	0.87	42	27	24	35	22	-	-
10FFS8L	¾	10	6	8L - M14x1,5		2	2.33	1.26	1.16	0.39	1.06	59.3	32	29.5	10	27	0.52	236
10FFS10L	¾	10	8	10L - M16x1,5		2	2.33	1.26	1.16	0.43	1.06	59.3	32	29.5	11	27	0.52	234
10FFS12L	¾	10	10	12L - M18x1,5		2	2.28	1.26	1.16	0.43	1.06	57.8	32	29.5	11	27	0.52	235
10FFS15L	¾	10	8,6	15L - M22x1,5		2	2.24	1.26	1.16	0.47	1.06	56.8	32	29.5	12	27	0.52	238
10FFS15LBH	¾	10	8,6	15L - M22x1,5		2	3.24	1.26	1.16	1.50	1.06	82.3	32	29.5	38	27	0.62	282
10FFS16S	¾	10	8,6	16S - M24x1,5 + bulkhead		2	2.26	1.26	1.16	0.55	1.06	57.3	32	29.5	14	27	0.46	211
10FFS56ORM	¾	10	8,6		¼ 18f UNF	2	2.61	1.26	1.06	0.47	0.94	66.4	32	27	12	23.8	-	-
10FFS75ORM	¾	10	8,6		¼ 16f UNF	2	2.61	1.26	1.06	0.55	0.94	66.4	32	27	14	23.8	-	-
12FFS15LBH	½	12	11	15L - M22x1,5 + bulkhead		2	3.66	1.50	1.56	1.50	1.42	93	38.2	39.5	38	36	1.05	478
12FFS16S	½	12	11	16S - M24x1,5		2	2.75	1.50	1.56	0.55	1.42	70	38.2	39.5	14	36	1.01	460
12FFS18LBH	½	12	11	18L - M26x1,5 + bulkhead		2	3.74	1.50	1.56	1.57	1.42	95	38.2	39.5	40.	36	1.17	534
16FFS15LBH	¾	16	12	15L - M22x1,5 + bulkhead		2	2.68	1.66	1.56	1.50	1.42	68	42.2	39.5	38	36	-	-
16FFS16S	¾	16	12	16S - M24x1,5		2	2.75	1.66	1.56	0.55	1.42	70	42.2	39.5	14	36	1.11	505
16FFS18LBH	¾	16	13	18L - M26x1,5 + bulkhead		2	2.68	1.66	1.56	1.57	1.42	68	42.2	39.5	40	36	-	-

* Alternative end connections available upon request.

To obtain connected length of coupling, add dimensions A (Fig. 1 or Fig. 2) and G (Fig. 3 or 4) together.

Note that ISO 8434-1 will restrict usage of coupling to 250 bar for end connection 8L, 10L, 12L and 15L, and to 160 bar for end connection 18L.

FLUID TRANSFER
AND HYDRAULIC

PNEUMATIC

SPECIAL APPLICATIONS

DIAGNOSTIC

AGRICULTURE

REFRIGERANT

FF Series (Steel) ISO 16028 Interchange

FLUID TRANSFER
AND HYDRAULIC

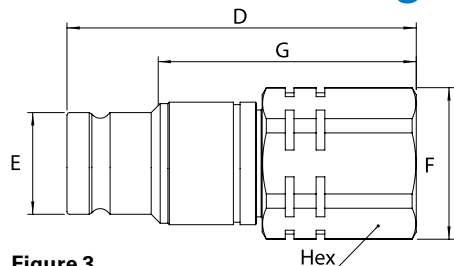
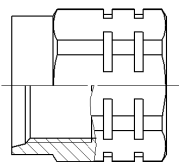
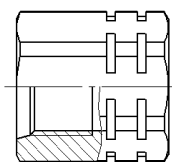

Figure 3

ISO 6149-1
15° + Metric thread



SAE J 1926-1
15° + UN/UNF thread



EATON S013A
15° + BSPP Thread

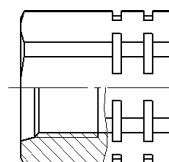

Plugs (Male)

Part Number	Body Size	ISO Size	Nominal Flow Diameter	Thread Size*(Female)			Dimensions											Weight				
				NPT	BSPP	ISO 6149-1	SAE J 1926-1	Eaton S013A	Fig.	D (in)	E (in)	F (in)	G (in)	Hex (in)	D (mm)	E (mm)	F (mm)	G (mm)	Hex (mm)	lbs	grams	
6FFP25	¼	6.3	6	¼ 18f						3	2.01	0.64	0.94	1.58	0.87	51	16.2	24	40.1	22	--	--
6FFP25BS	¼	6.3	6		¼-19					3	2.01	0.64	0.94	1.58	0.87	51	16.2	24	40.1	22	--	--
6FFP25FG	¼	6.3	6					G ¼		3	2.01	0.64	0.94	1.58	0.87	51	16.2	24	40.1	22	0.20	90
6FFP56UN	¼	6.3	6				¾ 18f UNF			3	2.05	0.64	0.94	1.62	0.87	52	16.2	24	41.1	22	--	--
10FFP16FMET	¾	10	8.6			M16x1,5				3	2.56	0.78	1.16	1.96	1.06	65	19.7	29.5	49.7	27	--	--
10FFP37	¾	10	8.6		¾ 18f					3	2.56	0.78	1.16	1.96	1.06	65	19.7	29.5	49.7	27	--	--
10FFP37BS	¾	10	8.6		¾-19					3	2.56	0.78	1.16	1.96	1.06	65	19.7	29.5	49.7	27	--	--
10FFP37FG	¾	10	8.6					G ¾		3	2.56	0.78	1.16	1.96	1.06	65	19.7	29.5	49.7	27	0.35	157
10FFP50	¾	10	8.6		½ 14f					3	2.68	0.78	1.16	2.08	1.06	68	19.7	29.5	52.7	27	--	--
10FFP50BS	¾	10	8.6		½-14					3	2.68	0.78	1.16	2.08	1.06	68	19.7	29.5	52.7	27	--	--
10FFP50FG	¾	10	8.6					G ½		3	2.68	0.78	1.16	2.08	1.06	68	19.7	29.5	52.7	27	0.33	150
10FFP56UN	¾	10	8.6				¾ 18f UNF			3	2.68	0.78	1.16	2.08	1.06	68	19.7	29.5	52.7	27	--	--
10FFP75UN	¾	10	8.6				¾ 16f UNF			3	2.68	0.78	1.16	2.08	1.06	68	19.7	29.5	52.7	27	--	--
10FFP87UN	¾	10	8.6				¾ 14f UNF			3	2.80	0.78	1.30	2.19	1.18	71	19.7	33	55.7	30	--	--
12FFP106UN	½	12.5	11				1 ½ 12f UN			3	2.95	0.96	1.56	2.28	1.42	75	24.5	39.5	58	36	--	--
12FFP50	½	12.5	11		½ 14f					3	2.71	0.96	1.56	2.05	1.42	69	24.5	39.5	52	36	--	--
12FFP50BS	½	12.5	11		½-14					3	2.71	0.96	1.56	2.05	1.42	69	24.5	39.5	52	36	--	--
12FFP50FG	½	12.5	11					G ½		3	2.71	0.96	1.56	2.05	1.42	69	24.5	39.5	52	36	0.67	305
12FFP75	½	12.5	11		¾ 14f					3	2.83	0.96	1.56	2.16	1.42	72	24.5	39.5	55	36	--	--
12FFP75BS	½	12.5	11		¾-14					3	2.83	0.96	1.56	2.16	1.42	72	24.5	39.5	55	36	--	--
12FFP75FG	½	12.5	11					G ¾		3	2.83	0.96	1.56	2.16	1.42	72	24.5	39.5	55	36	0.65	295
12FFP75UN	½	12.5	11				¾ 16f UNF			3	2.71	0.96	1.56	2.05	1.42	69	24.5	39.5	52	36	--	--
12FFP87UN	½	12.5	11				¾ 14f UNF			3	2.83	0.96	1.56	2.16	1.42	72	24.5	39.5	55	36	--	--
16FFP106UN	¾	16	13				1 ½ 12f UN			3	2.95	1.06	1.56	2.28	1.42	75	27	39.5	58	36	--	--
16FFP50	¾	16	13		½ 14f					3	2.71	1.06	1.56	2.05	1.42	69	27	39.5	52	36	--	--
16FFP50BS	¾	16	13		½-14					3	2.71	1.06	1.56	2.05	1.42	69	27	39.5	52	36	--	--
16FFP75	¾	16	13		¾ 14f					3	2.83	1.06	1.56	2.16	1.42	72	27	39.5	55	36	--	--
16FFP75BS	¾	16	13		¾-14					3	2.83	1.06	1.56	2.16	1.42	72	27	39.5	55	36	--	--
16FFP75FG	¾	16	13					G ¾		3	2.83	1.06	1.56	2.16	1.42	72	27	39.5	55	36	0.7	317
16FFP75UN	¾	16	13				¾ 16f UNF			3	2.71	1.06	1.56	2.05	1.42	69	27	39.5	52	36	--	--
16FFP87UN	¾	16	13				¾ 14f UNF			3	2.83	1.06	1.56	2.16	1.42	72	27	39.5	55	36	--	--
19FFP100	¾	19	15		1 11,5f					3	3.69	1.18	1.81	2.84	1.65	93.8	29.9	46	72	42	--	--
19FFP100BS	¾	19	15		1-11					3	3.69	1.18	1.81	2.84	1.65	93.8	29.9	46	72	42	--	--
19FFP100FG	¾	19	15					G 1		3	3.69	1.18	1.81	2.84	1.65	93.8	29.9	46	72	42	1.14	518
19FFP106UN	¾	19	15				1 ½ 12f UN			3	3.69	1.18	1.81	2.84	1.65	93.8	29.9	46	72	42	--	--
19FFP131UN	¾	19	15				1 ¾ 12f UN			3	3.69	1.18	1.81	2.84	1.65	93.8	29.9	46	72	42	--	--
19FFP75	¾	19	15		¾ 14f					3	3.69	1.18	1.81	2.84	1.65	93.8	29.9	46	72	42	--	--
19FFP75BS	¾	19	15		¾-14					3	3.69	1.18	1.81	2.84	1.65	93.8	29.9	46	72	42	--	--
25FFP100	1	25	18		1 11,5f					3	4.12	1.42	2.36	3.22	2.17	104.6	36	60	81.7	55	--	--
25FFP100BS	1	25	18		1-11					3	4.12	1.42	2.36	3.22	2.17	104.6	36	60	81.7	55	--	--
25FFP125	1	25	18		1 ¼ 11,5f					3	4.12	1.42	2.36	3.22	2.17	104.6	36	60	81.7	55	--	--
25FFP125BS	1	25	18		1¼-11					3	4.12	1.42	2.36	3.22	2.17	104.6	36	60	81.7	55	--	--
25FFP125FG	1	25	18					G 1¼		3	4.12	1.42	2.36	3.22	2.17	104.6	36	60	81.7	55	2.08	948
25FFP131UN	1	25	18				1 ½ 12f UN			3	4.12	1.42	2.36	3.22	2.17	104.6	36	60	81.7	55	2.09	952
25FFP162UN	1	25	18				1 ¾ 12f UN			3	4.12	1.42	2.36	3.22	2.17	104.6	36	60	81.7	55	--	--
32FFP125	1 ¼	-	22.1		1 ¼-11,5					3	4.15	1.73	2.36	3.24	2.17	105.5	44	60	82.3	55	2.63	1193
32FFP125BS	1 ¼	-	22.1		1 ¼-11					3	4.15	1.73	2.36	3.24	2.17	105.5	44	60	82.3	55	2.60	1177
32FFP162UN	1 ¼	-	22.1				1 5/8 12 UN			3	4.15	1.73	2.36	3.24	2.17	105.5	44	60	82.3	55	2.59	1174
40FFP150	1 ½	-	30.1		1 ½ 11,5					3	4.13	2.24	2.61	3.01	2.36	105	57	66.3	76.5	60	3.15	1430
40FFP150BS	1 ½	-	30.1		1 ½-11					3	4.13	2.24	2.61	3.01	2.36	105	57	66.3	76.5	60	3.12	1417
40FFP150FG	1 ½	-	30.1					1 ½		3	4.13	2.24	2.61	3.01	2.36	105	57	66.3	76.5	60	3.11	1412
40FFP187UN	1 ½	-	30.1				1 ¾ 12 UN			3	4.13	2.24	2.61	3.01	2.36	105	57	66.3	76.5	60	3.10	1406
50FFP200	2	-	39.2		2 11,5					3	5.31	2.87	3.29	3.80	2.95	135	73	83.5	96.6	75	6.01	2725
50FFP200BS	2	-	39.2		2-11					3	5.31	2.87	3.29	3.80	2.95	135	73	83.5	96.6	75	5.97	2706
50FFP250UN	2	-	39.2				2 ½ 12 UN			3	5.31	2.87	3.29	3.80	2.95	135	73	83.5	96.6	75	5.78	2623

* Alternative end connections available upon request.
To obtain connected length of coupling, add dimensions A (Fig. 1 or Fig. 2) and G (Fig. 3 or 4) together.

PNEUMATIC

SPECIAL APPLICATIONS

DIAGNOSTIC

AGRICULTURE

REFRIGERANT

FF Series (Steel) ISO 16028 Interchange

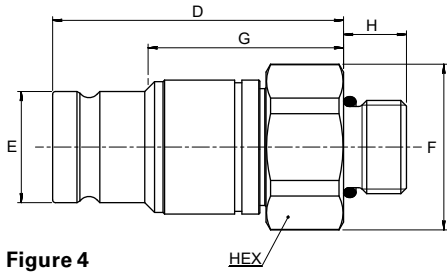
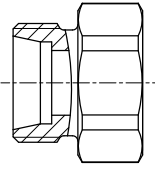
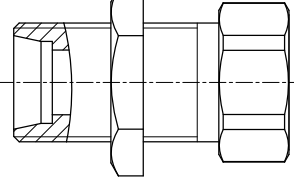

Figure 4

ISO 8434-1
Metric thread



ISO 8434-1 + Bulkhead
Metric thread



SAE J 1926-2
UN/UNF thread

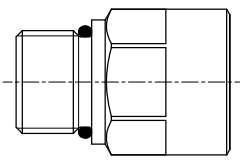

Plugs (Male)

Part Number	Body Size (in)	ISO Size (mm)	Nominal Flow Diameter (mm)	Thread Size*(Male)		Fig.	Dimensions										Weight			
				ISO 8434-1	SAE J 1926-2		D (in)	E (in)	F (in)	G (in.)	H (in)	Hex (in)	D (mm)	E (mm)	F (mm)	G (mm)	H (mm)	Hex (mm)	lbs	grams
6FFP10LBH	¼	6.3	6	M10L - M16x1,5 + bulkhead	SAE J 1926-2	4	1.54	0.64	0.94	1.11	1.38	0.87	39	16.2	24	28.1	35	22	0.27	123
10FFP8L	¾	10	6	8L - M14x1,5		4	2.20	0.78	1.16	1.84	0.39	1.06	56	19.7	29.5	46.7	10	27	0.3	137
10FFP10L	¾	10	8	10L - M16x1,5		4	2.17	0.78	1.16	1.84	0.43	1.06	55	19.7	29.5	46.7	11	27	0.3	135
10FFP12L	¾	10	10	12L - M18x1,5		4	2.17	0.78	1.16	1.41	0.43	1.06	55	19.7	29.5	35.7	11	27	0.3	136
10FFP15L	¾	10	8,6	5L - M22x1,5		4	2.13	0.78	1.16	1.84	0.47	1.06	54	19.7	29.5	46.7	12	27	0.31	139
10FFP15LBH	¾	10	8,6	15L - M22x1,5 + bulkhead		4	2.01	0.78	1.16	2.9	1.50	1.06	51	19.7	29.5	73.7	38	27	0.4	183
10FFP16S	¾	10	8,6	16S - M24x1,5		4	2.52	0.78	1.16	1.92	0.55	1.06	64	19.7	29.5	48.7	14	27	0.27	123
10FFP56ORM	¾	10	8,6		¼ 18f UNF	4	2.5	0.78	1.06	1.9	0.47	0.94	63.6	19.7	27	48.3	12	23.8	0.33	150
10FFP75ORM	¾	10	8,6		¼ 16f UNF	4	2.	0.78	1.06	1.	0.55	0.94	63.6	19.7	27	48.3	14	23.8	0.34	156
12FFP15LBH	½	12	11	15L - M22x1,5 + bulkhead		4	2.12	0.96	1.56	2.95	1	1.42	54	24.5	39.5	75	38	36	0.65	297
12FFP16S	½	12	11	16S - M24x1,5		4	2.71	0.96	1.56	2.05	0.55	1.42	69	24.5	39.5	52	14	36	0.61	279
12FFP18LBH	½	12	11	18L - M26x1,5 + bulkhead		4	2.12	0.96	1.56	3.03	1.57	1.42	54	24.5	39.5	77	40	36	0.78	353
16FFP15LBH	¾	16	12	15L - M22x1,5 + bulkhead		4	2.12	1.06	1.56	1.45	1.5	1.42	54	27	39.5	37	38	36	0.65	298
16FFP16S	¾	16	12	16S - M24x1,5		4	2.71	1.06	1.56	2.05	0.55	1.42	69	27	39.5	52	14	36	0.62	280
16FFP18LBH	¾	16	13	18L - M26x1,5 + bulkhead		4	2.12	1.06	1.56	1.45	1.57	1.42	54	27	39.5	37	40	36	0.78	353

*Alternative end connections available upon request.

To obtain connected length of coupling, add dimensions A (Fig. 1 or Fig. 2) and G (Fig. 3 or 4) together.

Note that ISO 8434-1 will restrict usage of coupling to 250 bar for end connection 8L, 10L, 12L and 15L, and to 160 bar for end connection 18L.

Socket (Female) Dust Plug

Body Size (in)	Body Size (in) with color ring	Part Number	Coupling Type	Dust Plug Material
¼	-	SDC6FF	Socket/Female	PVC
¾*	-	SDC10FF	Socket/Female	PVC
½	¾	SDC12FF	Socket/Female	PVC
¾	-	SDC16FF	Socket/Female	PVC
¾	½	SDC19FF	Socket/Female	PVC
1	¾	SDC25FF	Socket/Female	PVC

*Dust caps and dust plugs are offered in black.

Plug (Male) Dust Cap

Body Size (in)	Part Number	Coupling Type	Dust Plug Material
¼	PDC6FF	Plug/Male	PVC
¾*	PDC10FF	Plug/Male	PVC
½	PDC12FF	Plug/Male	PVC
¾	PDC16FF	Plug/Male	PVC
¾	PDC19FF	Plug/Male	PVC
1	PDC25FF	Plug/Male	PVC



Color Coding Ring Option*

Body Size (in)	ISO Size (mm)	Size	Socket/Female Ring Part Number**				Plug/Male Ring Part Number**				Tool Part Number	Tool & Rings Kit Part Number***
			Blue	Red	Yellow	Green	Blue	Red	Yellow	Green		
¼	6	6FF	CR6FFSLB	CR6FFSRD	CR6FFSYL	CR6FFSDG	CR6FFPLB	CR6FFPRD	CR6FFPYL	CR6FFPDG	CR6FFSP93	CRKIT6FF
¾	10	10FF	CR10FFSLB	CR10FFSRD	CR10FFSYL	CR10FFSDG	CR10FFPLB	CR10FFPRD	CR10FFPYL	CR10FFPDG	CR10FFSP93	CRKIT10FF
½	12.5	12FF	CR12FFSLB	CR12FFSRD	CR12FFSYL	CR12FFSDG	CR12FFPLB	CR12FFPRD	CR12FFPYL	CR12FFPDG	CR12FFSP93	CRKIT12FF
¾	16	16FF	CR16FFSLB	CR16FFSRD	CR16FFSYL	CR16FFSDG	CR16FFPLB	CR16FFPRD	CR16FFPYL	CR16FFPDG	CR16FFSP93	CRKIT16FF
¾	19	19FF	CR19FFSLB	CR19FFSRD	CR19FFSYL	CR19FFSDG	CR19FFPLB	CR19FFPRD	CR19FFPYL	CR19FFPDG	CR19FFSP93	CRKIT19FF

For color coded rings TPE material is used that offers excellent flexibility which allows a very good shock resistance in demanding applications.

Good thermal, chemical and weather resistance provides a great fit on the coupling and an extended life time in toughest conditions.

The color coded rings are easy to install by using the referenced tools. Please refer to the user guide on "eaton.com"

* For requests on alternative colors or installation instructions, please contact your Eaton sales representative.

** Orders must be in multiples of 10 pcs.

*** The kit consists of a tool plus 10 socket rings and 10 plug rings of each color.



MLFF Series (Stainless Steel) ISO 16028 Flat Face/Dry Break



Eaton's MLFF Series stainless steel coupling is a flat face dry break coupling used for hydraulic applications. The MLFF Series interchanges with all ISO 16028 profiles. Due to its stainless steel design, it is corrosion resistant and can handle aggressive environments.

Product Features

- Designed and manufactured under Article 4.3 of the European Pressure Equipment Directive PED 2014/68/EU
- Safety sleeve lock prevents accidental disconnections
- Push to connect with double shut-off valving
- Shock resistant color coding ring option available in sizes 10FF, 12FF, 16FF and 19FF to prevent accidental crossing of lines
- Resistant to aggressive environments and corrosion
- Utilize FF Series dust caps
- Standard body material: 316L Stainless steel corrosion resistant
- Alternative end connections available upon request
- Standard seal material: FKM, EPDM, NBR+AU, HNBR (upon request)

Physical Characteristics

ISO Size* (mm)	Coupling Size (in)	Maximum Operating Pressure						Minimum Burst Pressure						Rated Flow**		Fluid Loss	Air Inclusion	Force to Connect	
		Connected		Plug/ Male Half		Socket/ Female Half		Connected		Plug/ Male Half		Socket/ Female Half		(lpm)	(gpm)	ml-cc.	ml-cc.	N	Lbs
6.3	¼	250	3,625	250	3,625	250	3,625	2,335	33,858	1,640	23,780	1,330	19,285	17	4.49	0.004	0.007	80	18.0
10	¾	250	3,625	250	3,625	250	3,625	1,672	24,244	1,664	24,128	845	12,253	29	7.66	0.006	0.010	140	31.5
12	½	250	3,625	250	3,625	250	3,625	1,679	24,346	997	14,457	993	14,399	55	14.53	0.012	0.013	195	43.8
16	¾	250	3,625	250	3,625	250	3,625	1,190	17,255	950	13,775	880	12,760	67	17.70	0.016	0.030	205	46.1
19	¾	250	3,625	250	3,625	250	3,625	1,370	19,865	882	12,789	845	12,253	105	27.74	0.034	0.015	215	48.3
25	1	250	3,625	250	3,625	250	3,625	1,690	24,505	1,000	14,500	850	12,325	177	46.76	0.032	0.033	260	58.5
-	1½	250	3,625	250	3,625	250	3,625	750	10,875	750	10,875	750	10,875	450	118.9	0.265	0.445	385	86.6
-	2"	175	2,535	175	2,535	175	2,535	525	7,610	525	7,610	525	7,610	700	184.9	0.390	0.260	375	84.3

* The ISO size corresponds to the internal diameter of the hose or the external diameter of the rigid tube (as defined in ISO 4397 Standard)

** Indicated values refer to a 1 bar/14.5 psi pressure drop

Applications & Markets

- Construction
- Agriculture
- Iron and Steel Industry
- Railway
- Oil and Gas
- Marine
- Material Handling
- General Hydraulic Applications

European Pressure Equipment Directive

All couplings are designed and manufactured under Article 4.3 of the European Pressure Equipment Directive PED 2014/68/EU. Couplings with nominal diameters greater than 25 mm should not be used to convey gases in Group 1 (hazardous).

Flow Data

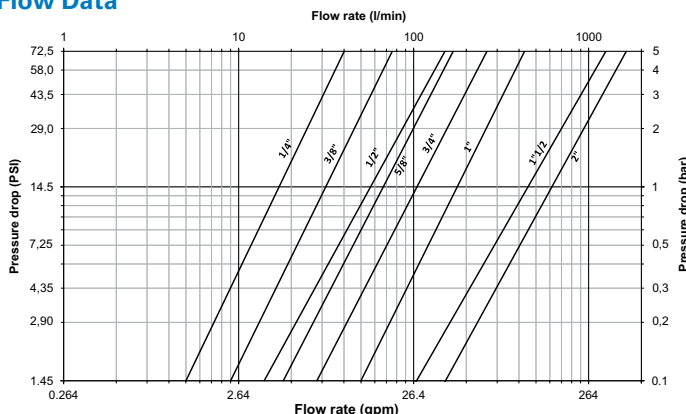

Seal Elastomer Data*

Seal Elastomer	P/N Code	ISO Size (6FF to 25FF) Maximum Operation Temperature Range	Non-ISO Size (40FF and 50FF) Maximum Operation Temperature Range
NBR (Nitrile) + AU (Polyurethane)	-	-25°C +100°C/-13°F +212°F	on request
FKM	-143	-20°C +200°C/-4°F +392°F	-20°C +200°C/-4°F +392°F
EPDM (Ethylene-Propylene)	-192	-40°C +150°C/-40°F +302°F	on request

*For reference only, based on Eaton recommended temperatures. Contact Eaton technical support for further information on fluid compatibility.

Maximum Operating Pressure

Coupling Size (in)	Nominal Flow Diameter	Non hazardous liquids Group 2		Non hazardous gases Group 2		Hazardous liquids Group 1	
		Plug & Connected	Socket	Plug & Connected	Socket	Plug & Connected	Socket
1 ½	30.1	300	4350	270	3915	66	955
2	39.2	300	4350	225	3260	50	725

* Nominal diameters over 25mm should not be used to convey gases in group 1 (PED 2014/68/EU)

MLFF Series (Stainless Steel) ISO 16028 Flat Face/Dry Break

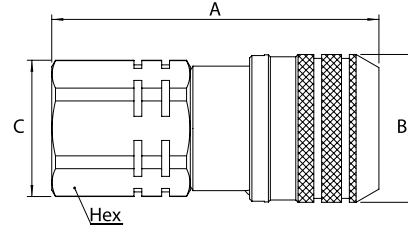

Figure 1

Sockets (Female)

Part Number			Body Size	ISO Size	Nominal Flow Diameter	Thread Size*(Female)		Dimensions				Weight						
NBR+AU	FKM	EPDM	(in)	(mm)	(mm)	NPT	BSP	Fig.	A (in)	B (in)	C (in)	Hex (in)	A (mm)	B (mm)	C (mm)	Hex (mm)	lbs	grams
ML6FFS25	ML6FFS25143	ML6FFS25192	¼	6.3	6	¼-18	-	1	2.13	1.06	0.94	0.87	54	27	24	22	0.30	135
ML6FFS25BS	ML6FFS25BS143	ML6FFS25BS192	¼	6.3	6	-	¼-19	1	2.13	1.06	0.94	0.87	54	27	24	22	0.30	135
ML10FFS37	ML10FFS37143	ML10FFS37192	⅜	10	8.6	⅜-18	-	1	2.68	1.26	1.16	1.06	68	32	29.5	27	0.54	245
ML10FFS37BS	ML10FFS37BS143	ML10FFS37BS192	⅜	10	8.6	-	⅜-19	1	2.68	1.26	1.16	1.06	68	32	29.5	27	0.54	245
ML10FFS50BS	ML10FFS50BS143	ML10FFS50BS192	⅜	10	8.6	-	½-14	1	2.80	1.26	1.16	1.06	71	32	29.5	27	0.53	240
ML12FFS50	ML12FFS50143	ML12FFS50192	½	12.5	11	½-14	-	1	3.27	1.50	1.56	1.42	83	38	39.5	36	1.03	470
ML12FFS50BS	ML12FFS50BS143	ML12FFS50BS192	½	12.5	11	-	½-14	1	3.27	1.50	1.56	1.42	83	38	39.5	36	1.03	470
ML12FFS75BS	ML12FFS75BS143	ML12FFS75BS192	½	12.5	11	-	¾-14	1	3.39	1.50	1.56	1.42	86	38	39.5	36	1.01	460
ML16FFS75	ML16FFS75143	ML16FFS75192	⅝	16	13	¾-14	-	1	3.39	1.66	1.56	1.42	86	42	39.5	36	1.21	550
ML16FFS75BS	ML16FFS75BS143	ML16FFS75BS192	⅝	16	13	-	¾-14	1	3.39	1.66	1.56	1.42	86	42	39.5	36	1.21	550
ML19FFS75	ML19FFS75143	ML19FFS75192	¾	19	15	¾-14	-	1	3.82	1.81	1.77	1.61	97	46	45	41	1.69	770
ML19FFS75BS	ML19FFS75BS143	ML19FFS75BS192	¾	19	15	-	¾-14	1	3.82	1.81	1.77	1.61	97	46	45	41	1.69	770
ML19FFS100	ML19FFS100143	ML19FFS100192	¾	19	15	1-11.5	-	1	3.80	1.82	1.77	1.61	97	46	45	41	1.56	710
ML19FFS100BS	ML19FFS100BS143	ML19FFS100BS192	¾	19	15	-	1-11	1	3.82	1.81	1.77	1.61	97	46	45	41	1.56	710
ML25FFS100BS	ML25FFS100BS143	ML25FFS100BS192	1	25	18	-	1-11	1	4.07	2.36	2.36	2.17	104	60	60	55	2.83	1290
ML25FFS125	ML25FFS125143	ML25FFS125192	1	25	18	1¼-11.5	-	1	4.07	2.36	2.36	2.17	104	60	60	55	2.83	1290
ML40FFS150	ML40FFS150143	-	1 ½	-	30.1	1½-11.5	-	1	5.01	3.13	2.76	2.56	127.4	79.5	70	65	6.16	2767
ML40FFS150BS	ML40FFS150BS143	-	1 ½	-	30.1	-	1 ½-11	1	5.01	3.13	2.76	2.56	127.4	79.5	70	65	6.13	2752
-	ML50FFS200143	-	2	-	39.2	2-11.5	-	1	6.17	3.84	3.46	3.15	156.8	97.5	87.8	80	10.87	4883
-	ML50FFS200BS143	-	2	-	39.2	-	2-11	1	6.17	3.84	3.46	3.15	156.8	97.5	87.8	80	10.82	4861

* Alternative end connections available upon request.
To obtain connected length of coupling, add dimensions A (Fig. 1) and G (Fig. 2) together.

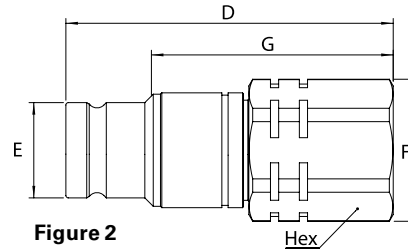

Figure 2

Plugs (Male)

Part Number			Body Size	ISO Size	Nominal Flow Diameter	Thread Size*(Female)		Dimensions				Weight								
NBR+AU	FKM	EPDM	(in)	(mm)	(mm)	NPT	BSP	Fig.	D (in)	E (in)	F (in)	G (in)	Hex (in)	D (mm)	E (mm)	F (mm)	G (mm)	Hex (mm)	lbs	grams
ML6FFP25	ML6FFP25143	ML6FFP25192	¼	6.3	6	¼-18	-	2	2.01	0.46	0.94	1.58	0.87	51	11.6	24	40.1	22	0.20	90
ML6FFP25BS	ML6FFP25BS143	ML6FFP25BS192	¼	6.3	6	-	¼-19	2	2.01	0.46	0.94	1.58	0.87	51	11.6	24	40.1	22	0.20	90
ML10FFP37	ML10FFP37143	ML10FFP37192	⅜	10	8.6	⅜-18	-	2	2.56	0.78	1.16	1.97	1.06	65	19.7	29.5	50	27	0.33	150
ML10FFP37BS	ML10FFP37BS143	ML10FFP37BS192	⅜	10	8.6	-	⅜-19	2	2.56	0.78	1.16	1.97	1.06	65	19.7	29.5	50	27	0.33	150
ML10FFP50BS	ML10FFP50BS143	ML10FFP50BS192	⅜	10	8.6	-	½-14	2	2.68	0.78	1.16	2.09	1.06	68	19.7	29.5	53	27	0.33	150
ML12FFP50	ML12FFP50143	ML12FFP50192	½	12.5	11	½-14	-	2	2.72	0.96	1.56	2.05	1.42	69	24.5	39.5	52	36	0.61	275
ML12FFP50BS	ML12FFP50BS143	ML12FFP50BS192	½	12.5	11	-	½-14	2	2.72	0.96	1.56	2.05	1.42	69	24.5	39.5	52	36	0.64	290
ML12FFP75BS	ML12FFP75BS143	ML12FFP75BS192	½	12.5	11	-	¾-14	2	2.83	0.96	1.56	2.17	1.42	72	24.5	39.5	55	36	0.61	275
ML16FFP75	ML16FFP75143	ML16FFP75192	⅝	16	13	¾-14	-	2	2.83	1.06	1.56	1.42	1.42	72	27	39.5	36	36	0.69	315
ML16FFP75BS	ML16FFP75BS143	ML16FFP75BS192	⅝	16	13	-	¾-14	2	2.83	1.06	1.56	1.42	1.42	72	27	39.5	36	36	0.69	315
ML19FFP75	ML19FFP75143	ML19FFP75192	¾	19	15	¾-14	-	2	3.70	1.18	1.77	2.83	1.61	94	29.9	45	72	41	1.28	580
ML19FFP75BS	ML19FFP75BS143	ML19FFP75BS192	¾	19	15	-	¾-14	2	3.70	1.18	1.77	2.83	1.61	94	29.9	45	72	41	1.28	580
ML19FFP100	ML19FFP100143	ML19FFP100192	¾	19	15	1-11.5	-	2	3.70	1.18	1.77	2.83	1.61	94	29.9	45	72	41	1.13	515
ML19FFP100BS	ML19FFP100BS143	ML19FFP100BS192	¾	19	15	-	1-11	2	3.70	1.18	1.77	2.83	1.61	94	29.9	45	72	41	1.12	510
ML25FFP100BS	ML25FFP100BS143	ML25FFP100BS192	1	25	18	-	1-11	2	4.12	1.42	2.36	2.17	2.17	104.6	36	60	55	55	2.37	1080
ML25FFP125	ML25FFP125143	ML25FFP125192	1	25	18	1¼-11.5	-	2	4.12	1.42	2.36	2.17	2.17	104.6	36	60	55	55	2.37	1080
ML40FFP150	ML40FFP150143	-	1 ½	-	30.1	1½-11.5	-	2	4.13	2.24	2.61	3.01	2.36	105	57	66.3	76.5	60	3.15	1411
ML40FFP150BS	ML40FFP150BS143	-	1 ½	-	30.1	-	1 ½-11	2	4.13	2.24	2.61	3.01	2.36	105	57	66.3	76.5	60	3.12	1398
-	ML50FFP200143	-	2	-	39.2	2-11.5	-	2	5.31	2.87	3.29	3.80	2.95	135	73	83.5	96.6	75	6.01	2729
-	ML50FFP200BS143	-	2	-	39.2	-	2-11	2	5.31	2.87	3.29	3.80	2.95	135	73	83.5	96.6	75	5.97	2710

* Alternative end connections available upon request.
To obtain connected length of coupling, add dimensions A (Fig. 1) and G (Fig. 2) together.

Color Coding Ring Option*

Body Size (in)	ISO Size (mm)	Size	Socket/Female Ring Part Number**				Plug/Male Ring Part Number**				Tool Part Number	Tool & Rings Kit Part Number***
			Blue	Red	Yellow	Green	Blue	Red	Yellow	Green		
¼	6	6FF	CR6FFSLB	CR6FFSRD	CR6FFSYL	CR6FFSDG	CR6FFPLB	CR6FFPRD	CR6FFPYL	CR6FFPDG	CR6FFSP93	CRKIT6FF
⅜	10	10FF	CR10FFSLB	CR10FFSRD	CR10FFSYL	CR10FFSDG	CR10FFPLB	CR10FFPRD	CR10FFPYL	CR10FFPDG	CR10FFSP93	CRKIT10FF
½	12.5	12FF	CR12FFSLB	CR12FFSRD	CR12FFSYL	CR12FFSDG	CR12FFPLB	CR12FFPRD	CR12FFPYL	CR12FFPDG	CR12FFSP93	CRKIT12FF
⅝	16	16FF	CR16FFSLB	CR16FFSRD	CR16FFSYL	CR16FFSDG	CR16FFPLB	CR16FFPRD	CR16FFPYL	CR16FFPDG	CR16FFSP93	CRKIT16FF
¾	19	19FF	CR19FFSLB	CR19FFSRD	CR19FFSYL	CR19FFSDG	CR19FFPLB	CR19FFPRD	CR19FFPYL	CR19FFPDG	CR19FFSP93	CRKIT19FF

For color coded rings TPE material is used that offers excellent flexibility which allows a very good shock resistance in demanding applications. Good thermal, chemical and weather resistance provides a great fit on the coupling and a extended life time in toughest conditions. The color coded rings are easy to install by using the referenced tools. Please refer to the user guide on "eaton.com"

* For requests on alternative colors or installation instructions, please contact your Eaton sales representative.

** Orders must be in multiples of 10 pcs.

*** The kit consists of a tool plus 10 socket rings and 10 plug rings of each color.



FFCUP Series ISO 16028 Connect Under Pressure Flat Face Plug/Male



Eaton's FFCUP Series plug/male coupling is an ISO 16028 standard interchange. The flush face design prevents fluid loss on disconnection and air inclusion on connection guaranteeing excellent flow capability. An integrated patented system allows the FFCUP Series plug to be connected to a socket/female half coupling under 350 bar (5075 psi) residual pressure.

Product Features

- Designed and manufactured in accordance with Article 4.3 of the European Pressure Equipment Directive PED 2014/68/EU
- Meets dimensional requirements of ISO 16028
- Push to connect
- Connect under residual pressure
- Shock resistant color coding ring option available to prevent accidental crossing of lines
- Standard Material: High-resistant carbon steel with Guardian Seal™ plating, a whole new level of corrosion resistance with minimum 720 hours RR protection
- Guardian Seal™ plating:
 - Nickel-free
 - Solvent-free
 - Meets Global RoHS, ELV and REACH requirements
- Alternative end connections available upon request
- Standard seal material: NBR (Nitrile) + AU (Polyurethane)
- Utilize FF Series dust caps

Physical Characteristics

Body Size	ISO Size*	Nominal Flow Diameter	Max. Operating Pressure	Min. Burst Pressure	Rated Flow**	Air Inclusion	Fluid Loss	Force to Connect				
(in)	(mm)	(mm)	(bar)	(psi)	(bar)	(psi)	(lpm)	(gpm)	ml-cc.	ml-cc.	N	lbf
3/8	10	8.6	350	5,075	1,400	20,300	29.4	7.76	0.010	0.006	350	79
1/2	12.5	11	350	5,075	1,400	20,300	46.8	12.36	0.013	0.012	270	60.7

* The ISO size corresponds to the internal diameter of the hose or the external diameter of the rigid tube (as defined in ISO 4397 Standard)

** Indicated values refer to a 1 bar/14.5 psi pressure drop

Connect Under Pressure Operating Guidelines

- The plug can be connected against 350 bar/5075 psi residual pressure to sockets/females meeting ISO 16028 standard requirements.
- Plug only is under pressure while connected
- During the connection phase, the socket must not be under pressure
- Disconnection under pressure is strictly forbidden
- Connection under pressure may require a few seconds: the force to connect must be maintained during this lapse of time

Flow Data

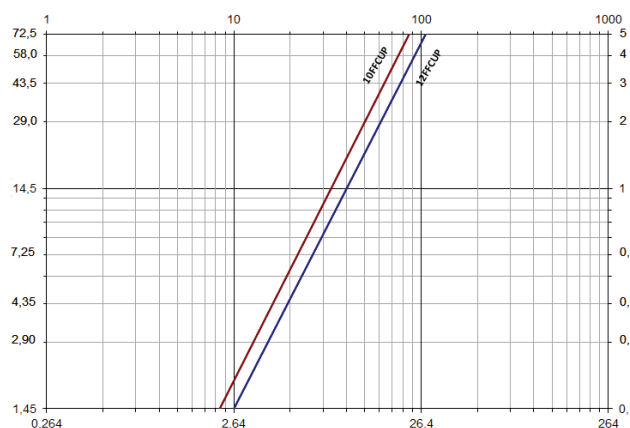

Seal Elastomer Data*

Seal Elastomer	Max. Operation Temperature Range
NBR (Nitrile) + AU (Polyurethane)	-25°C +100°C/-13°F +212°F

* For reference only, based on Eaton recommended temperatures. Contact Eaton technical support for further information on fluid compatibility

FFCUP Series ISO 16028 Connect Under Pressure Flat Face Plug/Male

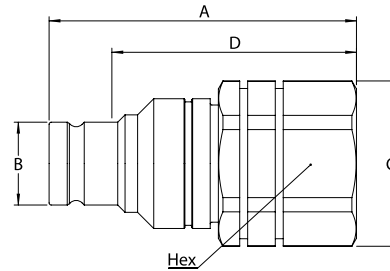

Figure 1

Plugs (Male)

Part Number	Body Size	ISO Size	Nominal Flow Diameter	Thread Size* (Female)		Dimensions										Weight		
				NPT	BSPP	SAE J 1926-1	Fig.	A (in)	B (in)	C (in)	D (in)	Hex (in)	A (mm)	B (mm)	C (mm)	D (mm)	Hex (mm)	lbs
10FFPCUP37	3/8	10	8.6	3/8-18	-	1	2.89	0.74	1.55	2.28	1.41	73.5	18.7	39.5	58.0	36	0.69	314
10FFPCUP37BS				-	3/8-19	1	2.89	0.74	1.55	2.28	1.41	73.5	18.7	39.5	58.0	36	0.69	314
10FFPCUP50				1/2-14	-	1	2.89	0.74	1.55	2.28	1.41	73.5	18.7	39.5	58.0	36	0.66	300
10FFPCUP50BS				-	1/2-14	1	2.89	0.74	1.55	2.28	1.41	73.5	18.7	39.5	58.0	36	0.66	300
12FFPCUP50	1/2	12,5	11	1/2-14	-	1	3.03	0.96	1.55	2.36	1.41	77	24,52	39,5	60	36	0,77	350
12FFPCUP50BS				-	1/2-14	1	3,03	0,96	1,55	2,36	1,41	77	24,52	39,5	60	36	0,76	346
12FFPCUP56UN				9/16 18f UNF	1	2,87	0,96	1,55	2,2	1,41	73	24,52	39,5	56	36	0,74	336	
12FFPCUP75UN				3/4 16f UNF	1	3,03	0,96	1,55	2,36	1,41	77	24,52	39,5	60	36	0,77	351	

* Alternative end connections available upon request.

Color Coding Ring Option*

Body Size (in)	ISO Size (mm)	Nominal Flow Diameter (mm)	Plug/Male Ring Part Number**				Tool Part Number
			Blue	Red	Yellow	Green	
3/8	10	8.6	CR12FFPLB	CR12FFPRD	CR12FFPYL	CR12FFPDG	CR12FFSP93
1/2	12,5	11	CR16FFPLB	CR16FFPRD	CR16FFPYL	CR16FFPDG	CR16FFSP93

For color coded rings TPE material is used that offers excellent flexibility which allows a very good shock resistance in demanding applications.

Good thermal, chemical and weather resistance provides a great fit on the coupling and a extended life time in toughest conditions.

The color coded rings are easy to install by using the referenced tools. Please refer to the user guide on "eaton.com"

* For requests on alternative colors or installation instructions, please contact your Eaton sales representative.

** Orders must be in multiples of 10 pcs.

*** The kit consists of a tool plus 10 socket rings and 10 plug rings of each color.



FLUID TRANSFER
AND HYDRAULIC

PNEUMATIC

SPECIAL APPLICATIONS

DIAGNOSTIC

AGRICULTURE

REFRIGERANT

FD96 Series

High Pressure Thread to Connect Flush Face

FLUID TRANSFER
AND HYDRAULIC

PNEUMATIC

SPECIAL APPLICATIONS

DIAGNOSTIC

AGRICULTURE

REFRIGERANT



Eaton's FD96 High Pressure Thread Together Flush Face Series is designed for high pressure and high impulse applications for hydraulic circuits. The FD96 Series design provides low connect and disconnect force in hydraulic circuits where trapped residual pressure must be addressed. The flush face design limits contamination and unwanted fluid loss. The FD96 Series is available in sizes 1/4" through 2" to best meet your specific size requirements.

Product Features

- Thread together design allows connection and disconnection under pressure up to 4,300 psi
- Low connection force
- Dual flush-face valving with non-spill design
- Working pressures up to 8,700 psi
- Body material: High-resistance carbon steel with zinc trivalent and black oxide plating

Applications & Markets

- Hydraulic Fluid Transfer
- High-impulse Hydraulics
- Oilfields
- Mining

Physical Characteristics

Body Size	Max. Operating Pressure						Min. Burst Pressure						Rated Flow (lpm)	Fluid Loss (gpm)	Req. Torque to Connect (lbs.)	Req. Torque to Connect (N)	
	Connected		Plug/Male Half		Socket/Female Half		Connected		Plug/Male Half		Socket/Female Half						
	(bar)	(psi)	(bar)	(psi)	(bar)	(psi)	(bar)	(psi)	(bar)	(psi)	(bar)	(psi)					(cc)
1/4	600	8,700	600	8,700	420	6,090	1,500	21,750	1,500	21,750	1,260	18,270	12	3.2	.012	29-37	40-50
3/8	550	7,980	550	7,980	330	4,785	1,400	20,300	1,400	20,300	1,000	14,500	23	6.1	.040	37-44	50-60
1/2	550	7,980	550	7,980	330	4,785	1,400	20,300	1,400	20,300	1,000	14,500	45	11.9	.025	48-55	65-75
3/4	550	7,980	550	7,980	330	4,785	1,400	20,300	1,400	20,300	1,000	14,500	74	19.6	.033	52-59	70-80
1	500	7,250	500	7,250	330	4,785	1,250	18,125	1,250	18,125	1,000	14,500	100	26.5	.018	66-81	90-110
1 1/4	470	6,800	470	6,800	300	4,350	1,200	17,400	1,200	17,400	800	11,600	189	50.1	.060	92-107	125-145
1 1/2	400	5,800	400	5,800	270	3,915	1,700	15,950	1,100	15,950	800	11,600	288	76.3	.200	114-129	155-175
2	350	5,080	350	5,080	270	3,915	1,100	15,950	1,100	15,950	800	11,600	379	100.4	.350	236-258	320-355

Flow Data

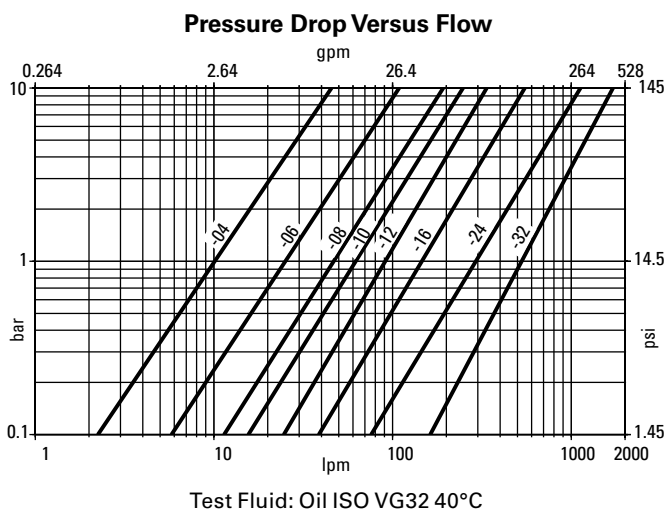

Connected Length

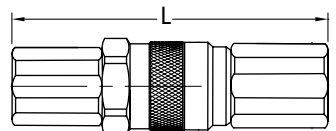

Body Size	Port Size	Connected Length "L"	
		mm	(in)
1/4	3/8	90.0	(3.54)
3/8	3/8	131.0	(5.16)
3/8	1/2	131.0	(5.16)
1/2	1/2	155.0	(6.10)
1/2	3/4	160.0	(6.30)
3/4	3/4	165.0	(6.50)
1	1	190.4	(7.50)
1	1 1/4	170.0	(6.69)
1 1/2	1 1/2	256.0	(10.08)
2	2	363.5	(14.31)

FD96 Series High Pressure Thread to Connect Flush Face

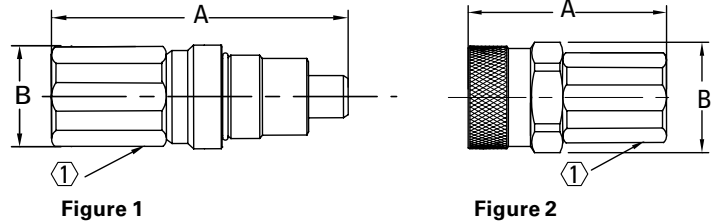

Dimensions (Female NPT)

Part Number	Coupling Type	Body Size	Port Size	Thread	Type	Fig.	Dimensions					
							A		B		Hex ①	
							mm	(in)	mm	(in)	mm	(in)
FD96-1001-06-06	Socket/Female	3/8	3/8	3/8-18	Female NPT	2	65.8	(2.59)	41.8	(1.65)	30	(1.18)
FD96-1002-06-06	Plug/Male	3/8	3/8	3/8-18	Female NPT	1	82.5	(3.25)	37.8	(1.49)	27	(1.06)
FD96-1001-08-06	Socket/Female	3/8	1/2	1/2-14	Female NPT	2	70.8	(2.79)	41.8	(1.65)	30	(1.18)
FD96-1002-08-06	Plug/Male	3/8	1/2	1/2-14	Female NPT	1	85.0	(3.35)	37.8	(1.49)	27	(1.06)
FD96-1001-08-08	Socket/Female	1/2	1/2	1/2-14	Female NPT	2	77.8	(3.06)	49.8	(1.96)	36	(1.42)
FD96-1002-08-08	Plug/Male	1/2	1/2	1/2-14	Female NPT	1	95.0	(3.74)	45.8	(1.80)	36	(1.42)
FD96-1001-12-08	Socket/Female	1/2	3/4	3/4-14	Female NPT	2	84.8	(3.06)	49.8	(1.96)	36	(1.42)
FD96-1002-12-08	Plug/Male	1/2	3/4	3/4-14	Female NPT	1	97.4	(3.83)	45.8	(1.80)	36	(1.42)
FD96-1001-12-12	Socket/Female	3/4	3/4	3/4-14	Female NPT	2	84.9	(3.34)	53.8	(2.12)	41	(1.61)
FD96-1002-12-12	Plug/Male	3/4	3/4	3/4-14	Female NPT	1	99.0	(3.90)	49.8	(1.96)	36	(1.42)
FD96-1001-12-16	Socket/Female	1	3/4	3/4-14	Female NPT	2	96.7	(3.81)	58.8	(2.31)	46	(1.81)
FD96-1002-12-16	Plug/Male	1	3/4	3/4-14	Female NPT	1	113.6	(4.47)	54.8	(2.16)	46	(1.81)
FD96-1001-16-16	Socket/Female	1	1	1-11 1/2	Female NPT	2	99.7	(3.93)	58.8	(2.31)	46	(1.81)
FD96-1002-16-16	Plug/Male	1	1	1-11 1/2	Female NPT	1	113.6	(4.47)	54.8	(2.16)	46	(1.81)
FD96-1001-16-20	Socket/Female	1 1/4	1	1-11 1/2	Female NPT	2	105.8	(4.17)	69.8	(2.75)	55	(2.17)
FD96-1002-16-20	Plug/Male	1 1/4	1	1-11 1/2	Female NPT	1	123.4	(4.86)	64.5	(2.54)	55	(2.17)
FD96-1001-20-20	Socket/Female	1 1/4	1 1/4	1 1/4-11 1/2	Female NPT	2	106.8	(4.20)	69.8	(2.75)	55	(2.17)
FD96-1002-20-20	Plug/Male	1 1/4	1 1/4	1 1/4-11 1/2	Female NPT	1	123.4	(4.86)	64.5	(2.54)	55	(2.17)
FD96-1001-20-24	Socket/Female	1 1/2	1 1/4	1 1/4-11 1/2	Female NPT	2	133.5	(5.26)	92.0	(3.62)	65	(2.56)
FD96-1002-20-24	Plug/Male	1 1/2	1 1/4	1 1/4-11 1/2	Female NPT	1	150.0	(5.91)	89.8	(3.54)	65	(2.56)
FD96-1001-24-24	Socket/Female	1 1/2	1 1/2	1 1/2-11 1/2	Female NPT	2	133.5	(5.26)	92.0	(3.62)	65	(2.56)
FD96-1002-24-24	Plug/Male	1 1/2	1 1/2	1 1/2-11 1/2	Female NPT	1	150.0	(5.91)	89.8	(3.54)	65	(2.56)
FD96-1001-32-32	Socket/Female	2	2	2-11 1/2	Female NPT	2	224.8	(8.85)	200.0	(7.87)	90	(3.54)
FD96-1002-32-32	Plug/Male	2	2	2-11 1/2	Female NPT	1	218.4	(8.60)	145.0	(5.71)	90	(3.54)

Dimensions (Female SAE O-Ring)

Part Number	Coupling Type	Body Size	Port Size	Thread	Type	Fig.	Dimensions					
							A		B		Hex ①	
							mm	(in)	mm	(in)	mm	(in)
FD96-1004-06-04	Socket/Female	1/4	3/8	3/8-18 UNF	Female SAE O-Ring	2	57.1	(2.25)	38.8	(1.53)	27	(1.06)
FD96-1005-06-04	Plug/Male	1/4	3/8	3/8-18 UNF	Female SAE O-Ring	1	72.8	(2.87)	34.8	(1.37)	22	(.87)
FD96-1004-08-06	Socket/Female	3/8	1/2	3/4-16 UNF	Female SAE O-Ring	2	70.8	(2.79)	41.8	(1.65)	30	(1.18)
FD96-1005-08-06	Plug/Male	3/8	1/2	3/4-16 UNF	Female SAE O-Ring	1	87.0	(3.43)	37.8	(1.49)	27	(1.06)
FD96-1004-12-08	Socket/Female	1/2	3/4	1 1/8-12 UNF	Female SAE O-Ring	2	84.8	(3.06)	49.8	(1.96)	36	(1.42)
FD96-1005-12-08	Plug/Male	1/2	3/4	1 1/8-12 UNF	Female SAE O-Ring	1	100.4	(3.95)	45.8	(1.80)	36	(1.42)
FD96-1004-12-12	Socket/Female	3/4	3/4	1 1/8-12 UNF	Female SAE O-Ring	2	84.9	(3.34)	53.8	(2.12)	41	(1.61)
FD96-1005-12-12	Plug/Male	3/4	3/4	1 1/8-12 UN	Female SAE O-Ring	1	102.0	(4.02)	49.8	(1.96)	36	(1.42)
FD96-1004-12-16	Socket/Female	1	3/4	1 1/8-12 UN	Female SAE O-Ring	2	99.7	(3.93)	58.8	(2.31)	46	(1.81)
FD96-1005-12-16	Plug/Male	1	3/4	1 1/8-12 UN	Female SAE O-Ring	1	115.6	(4.55)	54.8	(2.16)	46	(1.81)
FD96-1004-16-16	Socket/Female	1	1	1 3/8-12 UN	Female SAE O-Ring	2	99.7	(3.93)	58.8	(2.31)	46	(1.81)
FD96-1005-16-16	Plug/Male	1	1	1 3/8-12 UN	Female SAE O-Ring	1	113.6	(4.47)	54.8	(2.16)	46	(1.81)
FD96-1004-16-20	Socket/Female	1 1/4	1	1 3/8-12 UN	Female SAE O-Ring	2	105.8	(4.17)	69.8	(2.75)	55	(2.17)
FD96-1005-16-20	Plug/Male	1 1/4	1	1 3/8-12 UN	Female SAE O-Ring	1	125.4	(4.94)	64.5	(2.54)	55	(2.17)
FD96-1004-20-20	Socket/Female	1 1/4	1 1/4	1 3/8-12 UN	Female SAE O-Ring	2	106.8	(4.20)	69.8	(2.75)	55	(2.17)
FD96-1005-20-20	Plug/Male	1 1/4	1 1/4	1 3/8-12 UN	Female SAE O-Ring	1	123.4	(4.86)	64.5	(2.54)	55	(2.17)
FD96-1004-20-24	Socket/Female	1 1/2	1 1/4	1 3/8-12 UN	Female SAE O-Ring	2	133.5	(5.26)	92.0	(3.62)	65	(2.56)
FD96-1005-20-24	Plug/Male	1 1/2	1 1/4	1 3/8-12 UN	Female SAE O-Ring	1	150.0	(5.91)	89.8	(3.54)	65	(2.56)
FD96-1004-24-24	Socket/Female	1 1/2	1 1/2	1 3/8-12 UN	Female SAE O-Ring	2	133.5	(5.26)	92.0	(3.62)	65	(2.56)
FD96-1005-24-24	Plug/Male	1 1/2	1 1/2	1 3/8-12 UN	Female SAE O-Ring	1	150.0	(5.91)	89.8	(3.54)	65	(2.56)
FD96-1004-32-32	Socket/Female	2	2	2 1/2-12 UN	Female SAE O-Ring	2	224.8	(8.85)	200.0	(7.87)	90	(3.54)
FD96-1005-32-32	Plug/Male	2	2	2 1/2-12 UN	Female SAE O-Ring	1	218.4	(8.60)	145.0	(5.71)	90	(3.54)

Dust Caps and Dust Plugs

Body Size	Part Number	Coupling Type	Cap Material	Body Size	Part Number	Coupling Type	Cap Material
1/4	FD96-1009-04	Socket/Female	Aluminum	1/4	FD96-1010-04	Plug/Male	Aluminum
3/8	FD96-1009-06	Socket/Female	Aluminum	3/8	FD96-1010-06	Plug/Male	Aluminum
1/2	FD96-1009-08	Socket/Female	Aluminum	1/2	FD96-1010-08	Plug/Male	Aluminum
3/4	FD96-1009-12	Socket/Female	Aluminum	3/4	FD96-1010-12	Plug/Male	Aluminum
1	FD96-1009-16	Socket/Female	Aluminum	1	FD96-1010-16	Plug/Male	Aluminum
1 1/4	FD96-1009-20	Socket/Female	Aluminum	1 1/4	FD96-1010-20	Plug/Male	Aluminum
1 1/2	FD96-1009-24	Socket/Female	Aluminum	1 1/2	FD96-1010-24	Plug/Male	Aluminum
2	FD96-1009-32	Socket/Female	Aluminum	2	FD96-1010-32	Plug/Male	Aluminum

MLDB Series (Stainless Steel) Flat Face/Dry Break



Eaton's MLDB Series stainless steel coupling is a flat face/dry break coupling used for fluid transfer applications. The MLDB Series offers the ability to connect with less force, higher sealing performance and are available in multiple configurable end connections.

Product Features

- Designed and manufactured in accordance with Article 4.3 of the European Pressure Equipment Directive PED 2014/68/EU
- Safety sleeve lock prevents accidental disconnections
- Push to connect with double shut-off valving
- Capable of working under high temperature applications
- Shock-resistant color coding ring option available in 1/2" size
- Serviceable design allows for easy cleaning and seal replacement
- Designed with higher flow capacity and resistance to aggressive fluids and corrosion
- Standard body material: 316/316L Stainless steel corrosion resistant
- Standard seal material: FKM, EPDM, Kalrez® and generic FFKM

Physical Characteristics

Body Size (in)	Nominal Flow Diameter (mm)	Max. Operating Pressure		Rated* Flow		Air Inclusion ml-cc.	Fluid Loss ml-cc.	Force to Connect	
		(bar)	(psi)	(lpm)	(gpm)			N	lbf
1/4	5.9	25	360	15	4	0.002	0.001	85	19
1/2	11.5	25	360	73	19	0.012	0.025	150	34
3/4	15.0	25	360	120	32	0.030	0.050	170	38
1	18.5	25	360	200	53	0.150	0.130	180	41

* Indicated values refer to a 1 bar/14.5 psi pressure drop.

Applications & Markets

- Process/Fluid Transfer
- Cooling
- Corrosive Environments
- Chemicals/ Petrochemicals
- Pharmaceuticals
- Food Processing
- Electrical

Flow Data

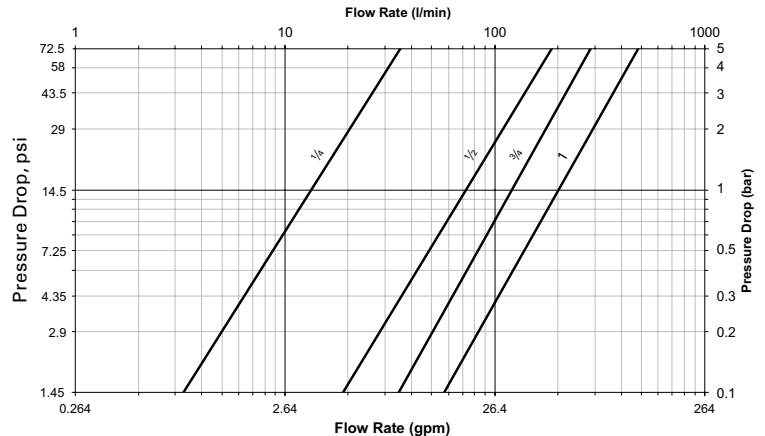

Seal Elastomer Data*

Seal Elastomer	Max. Operation Temperature Range
FKM	-20°C +200°C/-4°F +392°F
EPDM (Ethylene-Propylene)	-40°C +150°C/-40°F +302°F
Kalrez® 6375	-20°C +275°C/-4°F +527°F
Generic FFKM (Perfluorocarbon)	-15°C +275°C/+5°F +527°F

* For reference only, based on Eaton recommended temperatures. Contact Eaton technical support for further information on fluid compatibility

MLDB Series (Stainless Steel) Flat Face/Dry Break

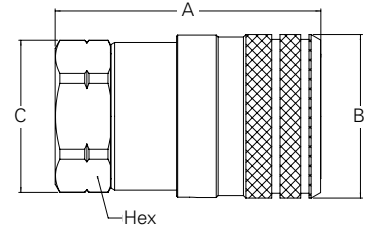

Figure 1

Sockets (Female)

Part Number				Thread Size*(Female)			Dimensions							Weight			
FKM	EPDM	Kalrez 6375	Generic FFKM	Body Size	NPT	BSPP	Fig.	A (in)	B (in)	C (in)	Hex (in)	A (mm)	B (mm)	C (mm)	Hex (mm)	lbs	grams
ML2DBS25FBS	ML2DBS25FBS292	ML2DBS25FBS242	ML2DBS25FBS503	¼	–	¼-19	1	1.79	1.06	0.96	0.87	45.4	26.8	24.5	22	0.26	116
ML2DBS25F	ML2DBS25F292	ML2DBS25F242	ML2DBS25F503	¼	¼-18		1	1.73	1.06	0.96	0.87	43.9	26.8	24.5	22	0.26	116
ML4DBS50FBS	ML4DBS50FBS292	ML4DBS50FBS242	ML4DBS50FBS503	½	–	½-14	1	2.44	1.5	1.4	1.26	61.9	38.2	35.5	32	0.73	330
ML4DBS50F	ML4DBS50F292	ML4DBS50F242	ML4DBS50F503	½	½-14		1	2.44	1.5	1.4	1.26	61.9	38.2	35.5	32	0.73	330
ML6DBS75FBS	ML6DBS75FBS292	ML6DBS75FBS242	ML6DBS75FBS503	¾	–	¾-14	1	3.02	1.89	1.83	1.61	76.8	47.9	46.5	41	1.34	610
ML6DBS75F	ML6DBS75F292	ML6DBS75F242	ML6DBS75F503	¾	¾-14		1	3.02	1.89	1.83	1.61	76.8	47.9	46.5	41	1.34	610
ML8DBS100FBS	ML8DBS100FBS292	ML8DBS100FBS242	ML8DBS100FBS503	1	–	1-11	1	3.54	2.26	2.16	1.97	89.9	57.4	54.9	50	2.31	1050
ML8DBS100F	ML8DBS100F292	ML8DBS100F242	ML8DBS100F503	1	1-11 ½		1	3.42	2.26	2.16	1.97	86.9	57.4	54.9	50	2.31	1050

*Alternative end connections available upon request.

To obtain connected length of coupling, add dimensions A (Fig. 1) and G (Fig. 2) together.

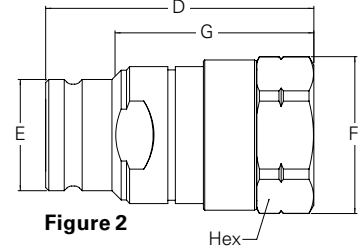

Figure 2

Plugs (Male)

Part Number				Thread Size*(Female)			Dimensions							Weight					
FKM	EPDM	Kalrez® 6375	Generic FFKM	Body Size	NPT	BSPP	Fig.	D (in)	E (in)	F (in)	G (in)	Hex (in)	D (mm)	E (mm)	F (mm)	G (mm)	Hex (mm)	lbs	grams
ML2DBP25FBS	ML2DBP25FBS292	ML2DBP25FBS242	ML2DBP25FBS503	¼	–	¼-19	2	1.72	0.65	0.96	1.31	0.87	43.6	16.5	24.5	33.2	22	0.17	78
ML2DBP25F	ML2DBP25F292	ML2DBP25F242	ML2DBP25F503	¼	¼-18		2	1.66	0.65	0.96	1.25	0.87	42.1	16.5	24.5	31.7	22	0.17	78
ML4DBP50FBS	ML4DBP50FBS292	ML4DBP50FBS242	ML4DBP50FBS503	½	–	½-14	2	2.39	0.99	1.4	1.8	1.26	60.7	25.2	35.5	45.7	32	0.46	210
ML4DBP50F	ML4DBP50F292	ML4DBP50F242	ML4DBP50F503	½	½-14		2	2.39	0.99	1.4	1.8	1.26	60.7	25.2	35.5	45.7	32	0.46	210
ML6DBP75FBS	ML6DBP75FBS292	ML6DBP75FBS242	ML6DBP75FBS503	¾	–	¾-14	2	2.97	1.29	1.83	2.11	1.61	75.5	32.8	46.5	53.6	41	0.87	395
ML6DBP75F	ML6DBP75F292	ML6DBP75F242	ML6DBP75F503	¾	¾-14		2	2.97	1.29	1.83	2.11	1.61	75.5	32.8	46.5	53.6	41	0.87	395
ML8DBP100FBS	ML8DBP100FBS292	ML8DBP100FBS242	ML8DBP100FBS503	1	–	1-11	2	3.52	1.59	2.16	2.60	1.97	89.4	40.4	54.9	66.1	50	1.54	700
ML8DBP100F	ML8DBP100F292	ML8DBP100F242	ML8DBP100F503	1	1-11 ½		2	3.4	1.59	2.16	2.48	1.97	86.4	40.4	54.9	63.1	50	1.54	700

*Alternative end connections available upon request.

To obtain connected length of coupling, add dimensions A (Fig. 1) and G (Fig. 2) together.

Seal Kit and Tool for Servicing Sockets (Female)

Body Size	Tool Part Number	Seal Kit Part Number (includes 5 sets)		Seal Kit Part Number (includes 1 set)	
		FKM	EPDM	Kalrez 6375	Generic FFKM
¼	ML2DBS93	2DBSG143	2DBSG292	2DBSG242	2DBSG503
½	ML4DBS93	4DBSG143	4DBSG292	4DBSG242	4DBSG503
¾	ML6DBS93	6DBSG143	6DBSG292	6DBSG242	6DBSG503
1	ML8DBS93	8DBSG143	8DBSG292	8DBSG242	8DBSG503

For installation instructions, please refer to the user guide on "eaton.com".

Seal Kit for Servicing Plugs (Male)

Body Size	Seal Kit Part Number (includes 5 sets)		Seal Kit Part Number (includes 1 set)	
	FKM	EPDM	Kalrez 6375	Generic FFKM
¼	2DBPG143	2DBPG292	2DBPG242	2DBPG503
½	4DBPG143	4DBPG292	4DBPG242	4DBPG503
¾	6DBPG143	6DBPG292	6DBPG242	6DBPG503
1	8DBPG143	8DBPG292	8DBPG242	8DBPG503

For installation instructions, please refer to the user guide on "eaton.com". No tool required for servicing of the plug(male).

Color Coding Ring Option*

Body Size (in)	ISO Size (mm)	Size	Socket/Female Ring Part Number**				Plug/Male Ring Part Number**				Tool Part Number	Tool & Rings Kit Part Number***
			Blue	Red	Yellow	Green	Blue	Red	Yellow	Green		
½	12.5	12FF	CR12FFSLB	CR12FFSRD	CR12FFSYL	CR12FFSDG	CR12FFPLB	CR12FFPRD	CR12FFPYL	CR12FFPDG	CR12FFSP93	CRKIT12FF

For color coded rings TPE material is used that offers excellent flexibility which allows a very good shock resistance in demanding applications. Good thermal, chemical and weather resistance provides a great fit on the coupling and a extended life time in toughest conditions. The color coded rings are easy to install by using the referenced tools. Please refer to the user guide on "eaton.com"

* For requests on alternative colors or installation instructions, please contact your Eaton sales representative.

** Orders must be in multiples of 10 pcs.

*** The kit consists of a tool plus 10 socket rings and 10 plug rings of each color.



ADB Series (Aluminium) Flat Face/Dry Break

FLUID TRANSFER
AND HYDRAULIC



Eaton's Aluminium Flat Face ADB coupling is a flat face/dry break coupling used for cooling systems in electric applications with circulating water and antifreeze fluids. This coupling is providing an enhanced solution for preventing spillage of cooling agent which can cause technical failures, system shutdowns, and difficult clean-ups.

Product Features

- Aluminium construction extends life for safer operations and reduced maintenance.
- Enhances operations in demanding applications with heat and vibration compared to plastic couplings.
- Up to 62% higher flow than ISO 16028 requirements to improve efficiency.
- 4-times safety factor at maximum operating pressure of 25 bar.
- Options are available for railway applications with an enhanced version for vibration resistance tested according to EN 61373.
- Pre-guided system that helps users pre-position the coupling in difficult environments, making connection easy and reducing maintenance time.
- Full range of optional seals, end connections and sizes, helping manufacturers benefit from the design in any type of application.

PNEUMATIC

SPECIAL APPLICATIONS

Physical Characteristics

ADB Model	ISO size	Body size	Nominal Flow Diameter	Max. Operating Pressure	Rated* Flow	Air Inclusion	Fluid Loss	Force to Connect		
-	(mm)	(in)	(mm)	(bar)	(psi)	(lpm)	ml-cc.	N	lbf	
A2DB	6.3	1/4"	5.9	25	360	25	0.002	0.001	77	17
A3DB	10	3/8"	9	25	360	80	0.012	0.03	103	23
A4DB	12.5	1/2"	11.5	25	360	110	0.012	0.025	110	25
A6DB	19	3/4"	15	25	360	150	0.03	0.05	193	43
A8DB	25	1"	18.5	25	360	290	0.15	0.13	180	40

* Indicated values refer to a 1 bar / 14.5 psi pressure drop with water values obtained by projection of pressure drops measured with Oil

Applications & Markets

- Electrical cooling applications
- Renewable energy
- Railway
- Processing industry
- Datacenters

DIAGNOSTIC

AGRICULTURE

REFRIGERANT

Flow Data

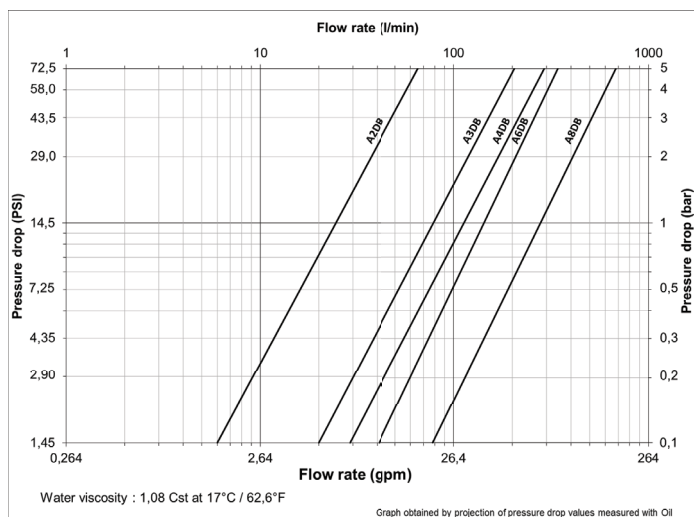

Seal Elastomer Data*

Seal Elastomer	Max. Operation Temperature Range
FKM	-20°C +200°C/-4°F +392°F
EPDM (Ethylene-Propylene)	-40°C +150°C/-40°F +302°F
Kalrez® 6375	-20°C +275°C/-4°F +527°F
Generic FFKM (Perfluorocarbon)	-15°C +275°C/+5°F +527°F

* For reference only, based on Eaton recommended temperatures.

Contact Eaton technical support for further information on fluid compatibility

ADB Series (Aluminium) Flat Face/Dry Break

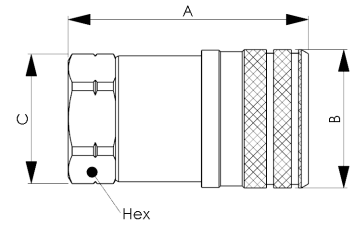

Figure 1

Sockets (Female)

Part Number	Thread Size		Dimensions								Weight	
	Body Size	BSPP	A (in)	B (in)	C (in)	Hex (in)	A (mm)	B (mm)	C (mm)	Hex (mm)	lbs	grams
A2DBS25BS192	1/4'	1/4'	1.84	1.06	0.96	0.87	46.7	26.8	24.5	22	0.098	44.4
A3DBS37BS192	3/8'	3/8'	2.42	1.26	1.16	1.06	61.5	32	29.5	27	0.186	84.3
A4DBS50BS192	1/2'	1/2'	2.49	1.49	1.4	1.26	63.3	37.9	35.5	32	0.276	125.4
A6DBS75BS192	3/4'	3/4'	3.48	1.89	1.83	1.61	88.5	48	46.5	41	0.597	270.7
A8DBS100BS192	1'	1'	3.70	2.26	2.16	1.97	93.9	57.4	54.9	50	0.928	421

*Alternative end connections available upon request.

To obtain connected length of coupling, add dimensions A (Fig. 1) and G (Fig. 2) together.

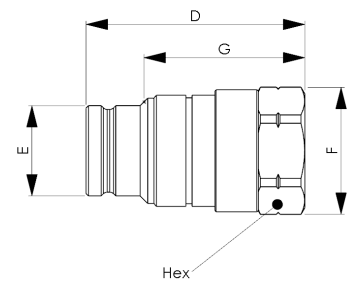

Figure 2

Plugs (Male)

Part Number	Thread Size		Dimensions								Weight			
	Body Size	BSPP	D (in)	E (in)	F (in)	G (in)	Hex (in)	D (mm)	E (mm)	F (mm)	G (mm)	Hex (mm)	lbs	grams
A2DBP25BS192	1/4'	1/4'	1.71	0.65	0.96	1.26	0.87	43.5	16.5	24.5	32.1	22	0.063	28.4
A3DBP37BS192	3/8'	3/8'	2.25	0.77	1.16	1.45	1.06	57.1	19.7	29.5	39.5	27	0.111	50.35
A4DBP50BS192	1/2'	1/2'	2.39	0.99	1.4	1.59	1.26	60.6	25.2	35.5	40.4	32	0.187	85
A6DBP75BS192	3/4'	3/4'	3.28	1.29	1.83	2.27	1.61	83.4	32.8	46.5	57.7	41	0.376	170.7
A8DBP100BS192	1'	1'	3.52	1.59	2.16	2.44	1.97	89.4	40.4	54.9	62	50	0.575	261

*Alternative end connections available upon request.

To obtain connected length of coupling, add dimensions A (Fig. 1) and G (Fig. 2) together.

Color Coding Ring Option*

Body Size (in)	ISO Size (mm)	Size	Socket/Female Ring Part Number**				Plug/Male Ring Part Number**				Tool Part Number	Tool & Rings Kit Part Number***
			Blue	Red	Yellow	Green	Blue	Red	Yellow	Green		
1/2	12.5	12FF	CR12FFSLB	CR12FFSRD	CR12FFSYL	CR12FFSDG	CR12FFPLB	CR12FFPRD	CR12FFPYL	CR12FFPDG	CR12FFSP93	CRKIT12FF

For color coded rings TPE material is used that offers excellent flexibility which allows a very good shock resistance in demanding applications.

Good thermal, chemical and weather resistance provides a great fit on the coupling and a extended life time in toughest conditions.

The color coded rings are easy to install by using the referenced tools. Please refer to the user guide on "eaton.com"

* For requests on alternative colors or installation instructions, please contact your Eaton sales representative.

** Orders must be in multiples of 10 pcs.

*** The kit consists of a tool plus 10 socket rings and 10 plug rings of each color.



FLUID TRANSFER
AND HYDRAULIC

PNEUMATIC

SPECIAL APPLICATIONS

DIAGNOSTIC

AGRICULTURE

REFRIGERANT

5100 Series Thread to Connect



Eaton's 5100 Series brass coupling with steel tubular valve offers minimum air inclusion and fluid loss. Thread together latch provides connect under pressure capability and vibration resistance. The 5100 Series is not rated for continuous hydraulic impulse applications. For hydraulic impulse applications, refer to the FD86 and FD96 Series thread to connect product lines.

Product Features

- Tubular valve construction for virtually no fluid loss during disconnection, reduces environmental and worker safety hazards
- Low air inclusion during connection maintains system performance
- Available with wing or hex nut configurations
- Connect against pressure capability allows connecting of halves even when pressurized up to 500 psi
- Steel flange available for accessible bulkhead mounting
- Standard seal material: Buna-N
- Standard body material: Brass body with high resistance carbon steel with zinc trivalent plated valving components, hex and wing nuts

Physical Characteristics

Body Dash Size	Body Interface Size	Max. Operating Pressure Connected		Max. Operating Pressure Disconnected				Rated Flow (lpm)	Rated Flow (gpm)	Air Inclusion cc. max.	Fluid Loss cc.max.	
				Plug/Male Half S2 and S4		Socket/Female Half S5						Vacuum (in./Hg)
(in)	(in)	(bar)	(psi)	(bar)	(psi)	(bar)	(psi)	(in./Hg)	(lpm)	(gpm)	cc. max.	cc.max.
¼	¼	207	3,000	207	3,000	207	3,000	28	15	4	.03	.01
⅜	½	207	3,000	207	3,000	207	3,000	28	26	7	.05	.06
½	½	207	3,000	207	3,000	207	3,000	28	26	7	.05	.10
⅝	¾	207	3,000	207	3,000	207	3,000	28	68	18	.14	.10
¾	¾	207	3,000	207	3,000	207	3,000	28	68	18	.34	.26
1	1	207	3,000	207	3,000	207	3,000	28	151	40	.50	.35
1¼	1¼	190	2,750	172	2,500	190	2,750	28	284	75	.68	.70
1½	1½	172	2,500	172	2,500	138	2,000	28	379	100	.60	.94

Applications & Markets

- Hydraulics and Fluid Transfer
- On-highway Hydraulic Wet Lines
- Dump and Refuse Vehicles
- Bulk Liquid Transfer

Flow Data

Pressure Drop Versus Flow Graph

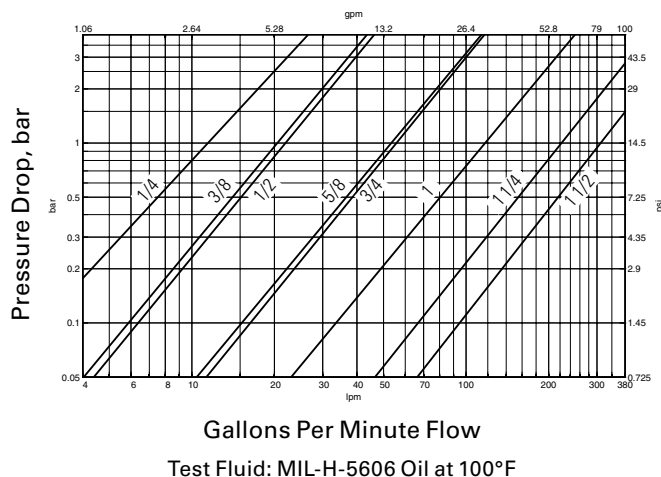

5100 Series Thread to Connect

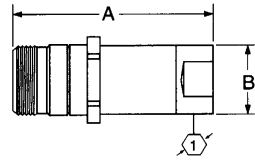

Figure 1

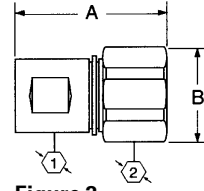

Figure 2

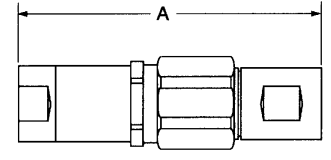

Figure 3

Dimensions (Female NPT, Valved without Flange)

Part Number Buna-N	Type	Coupling Size	Body Size	Port Thread	Type	Fig.	Dimensions		B		Hex ①		Hex ②	
							A		mm	(in)	mm	(in)	mm	(in)
5100-S2-4B	Plug/Male	¼	⅝	⅜-27	Female NPT	1	478	(1.88)	22.9	(.90)	175	(.69)	-	-
5110-S5-4B	Socket/Female	¼	⅝	⅜-27	Female NPT	2	53.3	(2.10)	33.5	(1.32)	14.2	(.56)	30.2	(1.19)
5111-4B	Complete	¼	¼	⅜-27	Female NPT	3	81.3	(3.20)	-	-	-	-	-	-
5100-S2-6B	Plug/Male	⅜	¾	¼-18	Female NPT	1	65.5	(2.58)	26.7	1.05	23.9	(.94)	-	-
5110-S5-6B	Socket/Female	⅜	¾	¼-18	Female NPT	2	61.0	(2.40)	38.9	(1.53)	19.3	(.76)	35.1	(1.38)
5111-6B	Complete	⅜	¾	¼-18	Female NPT	3	104.4	(4.11)	-	-	-	-	-	-
5100-S2-8B	Plug/Male	½	¾	⅝-18	Female NPT	1	65.5	(2.58)	26.7	(1.05)	23.9	(.94)	-	-
5110-S5-8B	Socket/Female	½	¾	⅝-18	Female NPT	2	61.0	(2.40)	38.9	(1.53)	19.3	(.76)	35.1	(1.38)
5111-8B	Complete	½	¾	⅝-18	Female NPT	3	104.4	(4.11)	-	-	-	-	-	-
5100-S2-10B	Plug/Male	⅝	½	½-14	Female NPT	1	79.0	(3.11)	35.1	(1.38)	30.2	(1.19)	-	-
5110-S5-10B	Socket/Female	⅝	½	½-14	Female NPT	2	78.0	(3.07)	50.3	(1.98)	29.5	(1.16)	44.5	(1.75)
5111-10B	Complete	⅝	½	½-14	Female NPT	3	132.3	(5.21)	-	-	-	-	-	-
5100-S2-12B	Plug/Male	¾	¾	¾-14	Female NPT	1	79.0	(3.11)	35.1	(1.38)	30.2	(1.19)	-	-
5110-S5-12B	Socket/Female	¾	¾	¾-14	Female NPT	2	78.0	(3.07)	50.3	(1.98)	29.5	(1.16)	44.5	(1.75)
5111-12B	Complete	¾	¾	¾-14	Female NPT	3	132.3	(5.21)	-	-	-	-	-	-
5100-S2-16B	Plug/Male	1	1	1-11½	Female NPT	1	90.2	(3.55)	44.2	(1.74)	39.6	(1.56)	-	-
5110-S5-16B	Socket/Female	1	1	1-11½	Female NPT	2	93.5	(3.68)	61.2	(2.41)	36.6	(1.44)	53.8	(2.12)
5111-16B	Complete	1	1	1-11½	Female NPT	3	151.9	(5.98)	-	-	-	-	-	-
5100-S2-20B	Plug/Male	1¼	1¼	1¼ - 11½	Female NPT	1	94.2	(3.71)	52.8	(2.08)	47.8	(1.88)	-	-
5110-S5-20B	Socket/Female	1¼	1¼	1¼ - 11½	Female NPT	2	101.6	(4.00)	58.7	(2.31)	45.2	(1.78)	63.5	(2.50)
5111-20B	Complete	1¼	1¼	1¼ - 11½	Female NPT	3	160.3	(6.31)	-	-	-	-	-	-
5100-S2-24B	Plug/Male	1½	1½	1½ - 11½	Female NPT	1	104.6	(4.12)	62.5	(2.46)	55.6	(2.19)	55.6	(2.19)
5110-S5-24B	Socket/Female	1½	1½	1½ - 11½	Female NPT	2	104.1	(4.10)	78.7	(3.10)	50.8	(2.00)	-	-
5111-24B	Complete	1½	1½	1½ - 11½	Female NPT	3	165.6	(6.52)	-	-	-	-	-	-

FLUID TRANSFER
AND HYDRAULIC

PNEUMATIC

SPECIAL APPLICATIONS

DIAGNOSTIC

AGRICULTURE

REFRIGERANT

5100 Series Thread to Connect

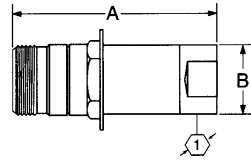

Figure 4

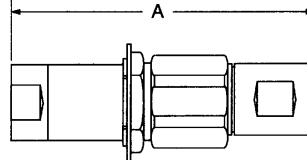

Figure 5

Dimensions (Female NPT, Valved WITH Flange)

Part Number Buna-N	Coupling Type	Body Size	Port Size	Thread	Type	Fig.	Dimensions A		B		Hex ①	
							mm	(in)	mm	(in)	mm	(in)
5100-S4-4B	Plug/Male	¼	⅜	⅜-27	Female NPT	4	47.8	(1.88)	22.4	(.88)	23.3	(.96)
5110-4B	Complete	¼	⅜	⅜-27	Female NPT	5	81.3	(3.20)	-	-	-	-
5100-S4-6B	Plug/Male	⅜	½	½-18	Female NPT	4	65.5	(2.58)	26.7	(1.05)	28.5	(1.12)
5110-6B	Complete	⅜	½	½-18	Female NPT	5	104.4	(4.11)	-	-	-	-
5100-S4-8B	Plug/Male	½	¾	¾-18	Female NPT	4	65.5	(2.58)	26.7	(1.05)	28.5	(1.12)
5110-8B	Complete	½	¾	¾-18	Female NPT	5	104.4	(4.11)	-	-	-	-
5100-S4-10B	Plug/Male	⅝	⅞	⅞-14	Female NPT	4	79.0	(3.11)	35.2	(1.35)	41.2	(1.62)
5110-10B	Complete	⅝	⅞	⅞-14	Female NPT	5	132.3	(5.21)	-	-	-	-
5100-S4-12B	Plug/Male	¾	1	1-14	Female NPT	4	79.0	(3.11)	35.2	(1.35)	41.2	(1.62)
5110-12B	Complete	¾	1	1-14	Female NPT	5	132.3	(5.21)	-	-	-	-
5100-S4-16B	Plug/Male	1	1	1-11½	Female NPT	4	90.2	(3.55)	44.2	(1.74)	47.8	(1.88)
5100-S4-20B	Plug/Male	1¼	1¼	1¼-11½	Female NPT	4	94.2	(3.71)	52.8	(2.08)	53.9	(2.12)
5110-20B	Complete	1¼	1¼	1¼-11½	Female NPT	5	160.3	(6.31)	-	-	-	-
5100-S4-24B	Plug/Male	1½	1½	1½-11½	Female NPT	4	104.6	(4.12)	62.5	(2.46)	63.5	(2.50)

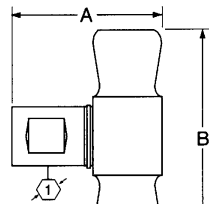

Figure 6

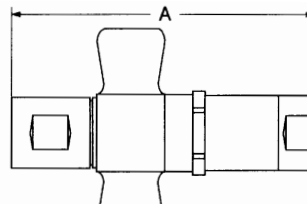

Figure 7

Dimensions (Female NPT, Valved WITH Wing Nut Less Flange)

Part Number Buna-N	Coupling Type	Body Size	Port Size	Thread	Type	Fig.	Dimensions A		B		Hex ①	
							mm	(in)	mm	(in)	mm	(in)
5100-S5-4B	Socket/Female	¼	⅜	⅜-27	Female NPT	6	53.3	(2.10)	77.0	(3.03)	14.2	(.56)
5101-4B	Complete	¼	⅜	⅜-27	Female NPT	7	81.3	(3.20)	-	-	-	-
5100-S5-6B	Socket/Female	⅜	½	½-18	Female NPT	6	61.0	(2.40)	87.4	(3.44)	19.3	(.76)
5101-6B	Complete	⅜	½	½-18	Female NPT	7	104.4	(4.11)	-	-	-	-
5100-S5-8B	Socket/Female	½	¾	¾-18	Female NPT	6	61.0	(2.40)	87.4	(3.44)	19.3	(.76)
5101-8B	Complete	½	¾	¾-18	Female NPT	7	104.4	(4.11)	-	-	-	-
5100-S5-10B	Socket/Female	⅝	⅞	⅞-14	Female NPT	6	78.0	(3.07)	104.9	(4.13)	29.5	(1.16)
5101-10B	Complete	⅝	⅞	⅞-14	Female NPT	7	132.3	(5.21)	-	-	-	-
5100-S5-12B	Socket/Female	¾	1	1-14	Female NPT	6	78.0	(3.07)	104.9	(4.13)	29.5	(1.16)
5101-12B	Complete	¾	1	1-14	Female NPT	7	132.3	(5.21)	-	-	-	-
5100-S5-16B	Socket/Female	1	1	1-11½	Female NPT	6	93.5	(3.68)	111.3	(4.38)	36.6	(1.44)
5101-16B	Complete	1	1	1-11½	Female NPT	7	151.9	(5.98)	-	-	-	-
5100-S5-20B	Socket/Female	1¼	1¼	1¼-11½	Female Pipe	6	101.6	(4.00)	133.9	(5.27)	45.2	(1.78)
5101-20B	Complete	1¼	1¼	1¼-11½	Female NPT	7	160.3	(6.31)	-	-	-	-
5100-S5-24B	Socket/Female	1½	1½	1½-11½	Female NPT	6	104.1	(4.10)	136.7	(5.38)	50.8	(2.00)
5101-24B	Complete	1½	1½	1½-11½	Female NPT	7	165.6	(6.52)	-	-	-	-

Note: Uses the 5100-S2 series plug/male half shown on page 49.

5100 Series Thread to Connect

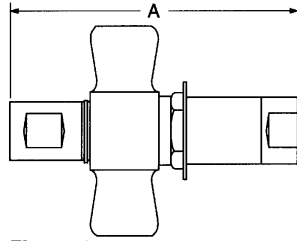

Figure 8

Dimensions (Female NPT, Valved WITH Wing Nut and Flange)

Part Number Buna-N	Coupling Type	Body Size	Port Size	Thread	Type	Dimensions Fig. A	
						mm	(in)
5100-4B	Complete	¼	⅛	⅛-27	Female NPT	8	81.3 (3.24)
5100-6B	Complete	⅜	¼	¼-18	Female NPT	8	104.4 (4.11)
5100-8B	Complete	½	⅜	⅜-18	Female NPT	8	104.4 (4.11)
5100-10B	Complete	⅝	½	½-14	Female NPT	8	132.3 (5.21)
5100-12B	Complete	¾	¾	¾-14	Female NPT	8	132.3 (5.21)
5100-16B	Complete	1	1	1-11½	Female NPT	8	151.9 (5.89)
5100-20B	Complete	1¼	1¼	1¼-11½	Female NPT	8	160.3 (6.33)
5100-24B	Complete	1½	1½	1½-11½	Female NPT	8	165.6 (6.54)

Note: Uses the 5100-S2 series plug/male half shown on page 49.

Repair Kits

Part Number Buna-N	Body Size
FF098-04	¼
FF098-08	⅜ & ½
FF098-12	⅝ & ¾
FF098-16	1
FF098-20	1¼
FF098-24	1½

Note: Each kit will repair both plug/male and socket/female halves.

Dust Caps and Dust Plugs

Part Number Dust Cap with Chain	Dust Plug with Chain	Body Size
5100-S7-5	5100-S9-5	¼
5100-S7-8	5100-S9-8	⅜ & ½
5100-S7-12	5100-S9-12	⅝ & ¾
5100-S7-16	5100-S9-16	1
5100-S7-20	5100-S9-20	1¼
5100-S7-24	5100-S9-24	1½

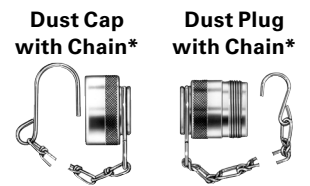

6-Bolt Flange Assembly

Part Number 6-Bolt Flange Assembly	Body Size	Dimensions A		B	
		mm	(in)	mm	(in)
150-22-5	¼	5.11	(.201)	33.6	(1.44)
150-22-8	⅜ & ½	5.11	(.201)	42.9	(1.69)
150-22-12	⅝ & ¾	5.11	(.201)	53.8	(2.12)
150-22-16	1	5.11	(.201)	60.5	(2.38)
150-22-20	1¼	5.11	(.201)	66.5	(2.62)
5100-22-245	1½	5.11	(.201)	82.6	(3.25)

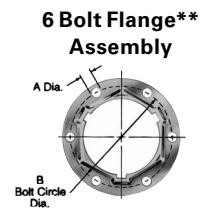

*To order caps and plugs without chain, order cap by part number 5100-32-(size) and plug by part number 5100-41-(size).

**6 Bolt Flange-holes equally spaced. (See "A" for bolt hole diameter, and "B" for bolt circle diameter).

FLUID TRANSFER
AND HYDRAULIC

PNEUMATIC

SPECIAL APPLICATIONS

DIAGNOSTIC

AGRICULTURE

REFRIGERANT

FD85 Series Thread to Connect



The Eaton FD85 Series is a thread to connect coupling most commonly used in Oil and Gas applications, but can also be found on demanding applications on both mobile and stationary equipment where operating pressures of 5,000 psi are present.

Product Features

- Thread to connect feature allows for use in high vibration and impulse applications
- Standard body material: Zinc trivalent plated carbon steel. Stainless steel construction available upon request
- Connect under pressure capability up to 5,000 psi (345 bar)
- Standard seal material: Buna-N. FKM seals are available upon request
- Wing nut and hex flat design allows for easy connection and disconnection
- 3/4" design is offered in a hex nut design
- Female NPTF and BSPP ends available

Physical Characteristics

Body Size (in)	Maximum Operating Pressure						Minimum Burst Pressure						Rated Flow		Fluid Loss	Air Inclusion
	Connected		Plug/ Male Half		Socket/ Female Half		Connected		Plug/ Male Half		Socket/ Female Half		Flow		ml-cc.	ml-cc.
	bar	(psi)	bar	(psi)	bar	(psi)	bar	(psi)	bar	(psi)	bar	(psi)	L/min	(gpm)		
3/4"	345	5,000	345	5,000	345	5,000	1,380	20,000	1,380	20,000	1,380	20,000	100	26.4	10	10
1"	345	5,000	345	5,000	345	5,000	1,380	20,000	1,380	20,000	1,380	20,000	189	50	20	26
1 1/4"	345	5,000	345	5,000	345	5,000	1,035	15,000	1,035	15,000	1,035	15,000	288	76	20	40
1 1/2"	345	5,000	345	5,000	345	5,000	1,035	15,000	1,035	15,000	1,035	15,000	379	100	83	85
2"	345	5,000	345	5,000	345	5,000	1,035	15,000	1,035	15,000	1,035	15,000	757	200	181	240

Applications & Markets

- Oilfields
- Offshore Drilling
- Construction
- Oil and Gas

Lloyd's Register Certification

The FD85 Series carries a Lloyd's Registry Certificate for fire conditions outlined in API 16D and EUB Directive 36. These parts meet the requirements that couplings shall be capable of maintaining pressure when exposed to a 700°C (1,300°F) temperature for a five-minute period in connected state.

Certification only applies to those assemblies where both mating parts socket/female and plug/male are Eaton FD85 Series thread to connect couplings.

Flow Data

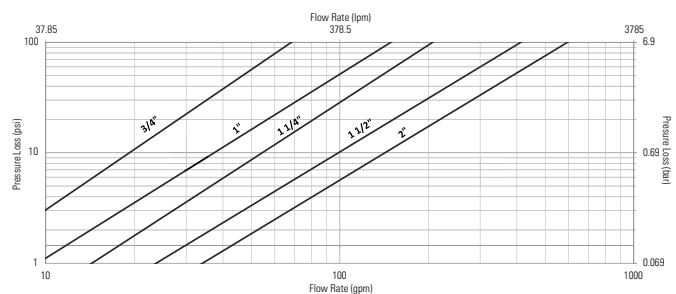

FD85 Series Thread to Connect

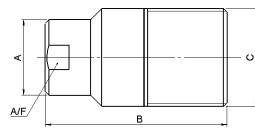

Figure 1

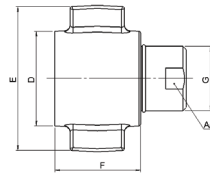

Figure 2

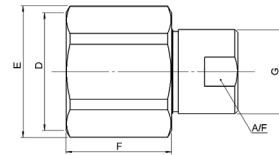

Figure 3

Plugs (Male)

Part Number	Body Size (in)	Thread Size (Female)		Fig.	Dimensions							Weight		
		NPT	BSPP		A (in)	B (in)	C (in)	A (mm)	B (mm)	C (mm)	A/F (in)	A/F (mm)	Lbs	grams
FD85-1001-12-12	¾	¾-14		1	1.39	3.27	1.74	35.2	83.1	44.3	1 1/3	33	1.162	480
FD85-1017-12-12	¾		G ¾-14	1	1.39	3.27	1.74	35.2	83.1	44.3	1 1/3	33	1.162	480
FD85-1001-16-16	1	1-11 1/2		1	1.77	4.17	2.25	45	106	57.1	1 5/8	41	2.921	1120
FD85-1017-16-16	1		G 1 - 11	1	1.77	4.17	2.25	45	106	57.1	1 5/8	41	2.974	1120
FD85-1001-20-20	1 ¼	1 ¼ - 11		1	2.15	5.37	2.62	54.5	136.4	66.6	2	50	5.633	1875
FD85-1017-20-20	1 ¼		G 1 ¼ - 11	1	2.15	5.37	2.62	54.5	136.4	66.6	2	50	5.633	1875
FD85-1001-24-24	1 ½	1 ½ - 11 ½		1	2.5	5.99	3.25	63.5	152.2	82.55	2 3/8	60	7.721	3150
FD85-1017-24-24	1 ½		G 1 ½ - 11	1	2.5	5.99	3.25	63.5	152.2	82.55	2 3/8	60	7.721	3150
FD85-1001-32-32	2	2 - 11 ½		1	3.25	7	4	82.5	179.2	101.6	3	76	15.046	5635
FD85-1017-32-32	2		G 2" - 11	1	3.25	7	4	82.5	179.2	101.6	3	76	15.046	5635

Sockets (Female)

Part Number	Body Size (in)	Thread Size (Female)		Fig.	Dimensions							Weight				
		NPT	BSPP		D (in)	E (in)	F (in)	G (in)	D (mm)	E (mm)	F (mm)	G (mm)	A/F (in)	A/F (mm)	Lbs	grams
FD85-1003-12-12	¾	¾-14		3	1.94	2.17	1.74	1.39	49.2	55	44.3	35.2	1 1/3	33	1.162	527
FD85-1019-12-12	¾		G ¾-14	3	1.94	2.17	1.74	1.39	49.2	55	44.3	35.2	1 1/3	33	1.162	527
FD85-1003-16-16	1	1-11 ½		2	2.68	4.25	2.2	1.77	68	108	56	45	1 5/8	41	2.921	1325
FD85-1019-16-16	1		G 1 - 11	2	2.68	4.25	2.2	1.77	68	108	56	45	1 5/8	41	2.974	1349
FD85-1003-20-20	1 ¼	1 ¼ - 11		2	3.15	4.72	2.8	2.15	80	120	71	54.5	2	50	5.633	2555
FD85-1019-20-20	1 ¼		G 1 ¼ - 11	2	3.15	4.72	2.8	2.15	80	120	71	54.5	2	50	5.633	2555
FD85-1003-24-24	1 ½	1 ½ - 11 ½		2	3.66	5.67	3.31	2.5	93	144	84	63.5	2 3/8	60	7.721	3502
FD85-1019-24-24	1 ½		G 1 ½ - 11	2	3.66	5.67	3.31	2.5	93	144	84	63.5	2 3/8	60	7.721	3502
FD85-1003-32-32	2	2 - 11 ½		2	4.67	6.67	4.35	3.25	118.6	169.4	110.5	82.5	3	76	15.046	6825
FD85-1019-32-32	2		G 2 - 11	2	4.67	6.67	4.35	3.25	118.6	169.4	110.5	82.5	3	76	15.046	6825

Complete Sets

Part Number	Coupling Type	Body Size	Thread	Fig.
FD85-1000-12-12	Complete	¾	¾-14 NPTF	1 & 3
FD85-1016-12-12	Complete	¾	¾-14 BSPP	1 & 3
FD85-1000-16-16	Complete	1	1 11-½ NPTF	1 & 2
FD85-1016-16-16	Complete	1	1 11 BSPP	1 & 2
FD85-1000-20-20	Complete	1 ¼	1 ¼ - 11 NPTF	1 & 2
FD85-1016-20-20	Complete	1 ¼	1 ¼ - 11 BSPP	1 & 2
FD85-1000-24-24	Complete	1 ½	1 ½ 11-½ NPTF	1 & 2
FD85-1016-24-24	Complete	1 ½	1 ½ 11 BSPP	1 & 2
FD85-1000-32-32	Complete	2	2 11 ½ NPTF	1 & 2
FD85-1016-32-32	Complete	2	2 11 BSPP	1 & 2

FD86 Series Thread to Connect 5,000 psi Dry Break – High Impulse



Eaton’s FD86 Series is a thread together steel quick coupling offering dry break and high impulse technology and capabilities. The maximum operating pressure is 5,000 psi. The FD86 Series is available in either wing nut or hex nut configurations for ease of assembly and disassembly. (For higher pressure applications and additional size requirements, refer to FD96 on page 44.)

Product Features

- Tubular valve and sleeve construction for low fluid loss and air inclusion
- Thread together design using wing or hex nut allows connection and disconnection against pressures up to 750 psi
- Teflon* back-up rings along with secondary metal-to-metal sealing contact provides high impulse capability up to 5,000 psi operating pressure
- Acme threads prevent galling and provide ease of connection
- Steel flange available for bulkhead mounting
- Standard seal material: Buna-N
- Standard body material: High resistance carbon steel with zinc trivalent plating

Physical Characteristics

Body Size (in)	Max. Operating Pressure		Min. Burst Pressure		Vacuum Connected Only (in./Hg)	Rated Flow		Air Inclusion cc. max.	Fluid Loss cc.max.
	(bar)	(psi)	(bar)	(psi)		(lpm)	(gpm)		
1	345	5,000	1,034	15,000	28	189	50	2.90	0.72
1 1/4	345	5,000	1,034	15,000	28	284	75	4.61	1.00

Applications & Markets

- Hydraulic and Fluid Transfer
- Mining Equipment

Flow Data

Pressure Drop Versus Flow Graph

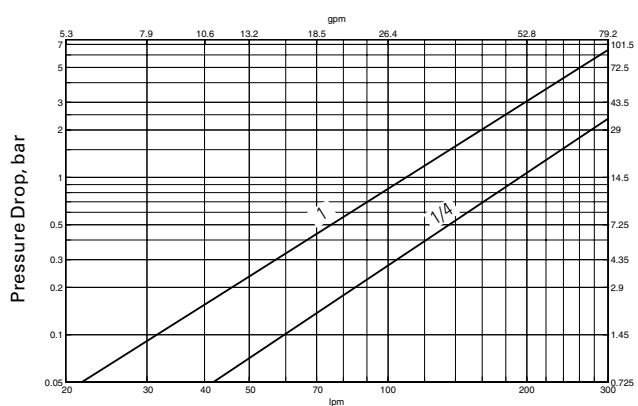

Gallons Per Minute Flow

Test Fluid: MIL-H-5606 Oil at 100°F

FD86 Series Thread to Connect 5,000 psi Dry Break – High Impulse

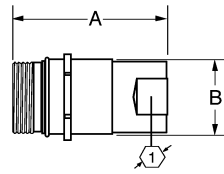

Figure 1

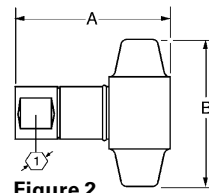

Figure 2

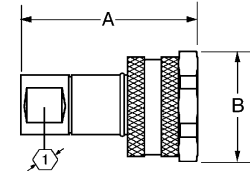

Figure 3

Dimensions (Female SAE O-Ring)

Part Number	Buna-N	FKM	EPDM	Type	Body Size	Port Size	Thread	Type	Fig.	Dimensions					
										A	B	Hex			
										mm	(in)	mm	(in)	mm	(in)
FD86-1008-16-16	FD86-1043-16-16	FD86-1053-16-16	Plug/Male	1	1%	1%	1/8 - 12	Female SAE O-Ring	1	102.4	(4.03)	53.6	(2.11)	44.5	(1.75)
FD86-1010-16-16	FD86-1044-16-16	FD86-1054-16-16	Socket/Female	1	1%	1%	1/8 - 12	Female SAE O-Ring	2	117.3	(4.62)	114.3	(4.50)	-	-
FD86-1006-16-16	FD86-1042-16-16	FD86-1052-16-16	Socket/Female	1	1%	1%	1/8 - 12	Female SAE O-Ring	3	117.3	(4.62)	71.4	(2.81)	15.8	(1.62)
FD86-1008-20-20	FD86-1043-20-20	FD86-1053-20-20	Plug/Male	1 1/4	1%	1%	1/8 - 12	Female SAE O-Ring	1	105.7	(4.16)	63.0	(2.48)	57.2	(2.25)
FD86-1010-20-20	FD86-1044-20-20	FD86-1054-20-20	Socket/Female	1 1/4	1%	1%	1/8 - 12	Female SAE O-Ring	2	132.6	(5.22)	133.4	(5.25)	-	-
FD86-1006-20-20	FD86-1042-20-20	FD86-1052-20-20	Socket/Female	1 1/4	1%	1%	1/8 - 12	Female SAE O-Ring	3	132.6	(5.22)	86.4	(3.40)	50.8	(2.00)

Dimensions (Female NPT)

Part Number	Buna-N	FKM	EPDM	Type	Body Size	Port Size	Thread	Type	Fig.	Dimensions					
										A	B	Hex			
										mm	(in)	mm	(in)	mm	(in)
FD86-1002-16-16	FD86-1040-16-16	FD86-1050-16-16	Plug/Male	1	1 - 11 1/2	1 - 11 1/2	1 - 11 1/2	Female NPT	1	111.8	(4.40)	53.6	(2.11)	44.5	(1.75)
FD86-1001-16-16	FD86-1039-16-16	FD86-1049-16-16	Socket/Female	1	1 - 11 1/2	1 - 11 1/2	1 - 11 1/2	Female NPT	2	126.5	(4.98)	114.3	(4.50)	-	-
FD86-1004-16-16	FD86-1041-16-16	FD86-1051-16-16	Socket/Female	1	1 - 11 1/2	1 - 11 1/2	1 - 11 1/2	Female NPT	3	126.5	(4.98)	71.4	(2.81)	15.8	(1.62)
FD86-1002-20-20	FD86-1040-20-20	FD86-1050-20-20	Plug/Male	1 1/4	1 1/4 - 11 1/2	1 1/4 - 11 1/2	1 1/4 - 11 1/2	Female NPT	1	112.5	(4.43)	63.0	(2.48)	57.2	(2.25)
FD86-1001-20-20	FD86-1039-20-20	FD86-1049-20-20	Socket/Female	1 1/4	1 1/4 - 11 1/2	1 1/4 - 11 1/2	1 1/4 - 11 1/2	Female NPT	2	142.8	(5.62)	133.4	(5.25)	-	-
FD86-1004-20-20	FD86-1041-20-20	FD86-1051-20-20	Socket/Female	1 1/4	1 1/4 - 11 1/2	1 1/4 - 11 1/2	1 1/4 - 11 1/2	Female NPT	3	142.8	(5.62)	86.4	(3.40)	50.8	(2.00)

Repair Kits

Part Number	Buna-N	FKM	EPDM	Body Size	Coupling Type
FF10596-16	FF10597-16	FF10598-16	1	Male	
FF10593-16	FF10594-16	FF10595-16	1	Female	
FF10596-20	FF10597-20	FF10598-20	1 1/4	Male	
FF10593-20	FF10594-20	FF10595-20	1 1/4	Female	

Dust Caps and Dust Plugs

Part Number	Dust Cap with Chain	Dust Plug with Chain	Body Size
FD86-1018-16	FD86-1016-16	1	
FD86-1018-20	FD86-1016-20	1 1/4	

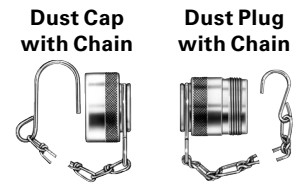

FLUID TRANSFER
AND HYDRAULIC

PNEUMATIC

SPECIAL APPLICATIONS

DIAGNOSTIC

AGRICULTURE

REFRIGERANT

W46000 Series

FLUID TRANSFER
AND HYDRAULIC



Eaton's W46000 Series is a wing nut style screw to connect coupling used in hydraulic applications.

PNEUMATIC

Product Features

- Wing nut screw to connect
- Plug/Male half has bulkhead mount capability
- Metal dust caps and dust plugs
- Standard body material: Zinc trivalent plated steel
- Standard seal material: Nitrile

SPECIAL APPLICATIONS

Physical Characteristics

Coupling Size (in)	DN/ND	Max. Operating Pressure		Min. Burst Pressure		Rated Flow		Air Inclusion
		(bar)	(psi)	(bar)	(psi)	(lpm)	(gpm)	ml max
3/4	16	250	3625	1200	17404	63	16,7	10
1	20	230	3335	800	11603	99	26,0	15

DIAGNOSTIC

Applications & Markets

- Hydraulic Circuits

Flow Data

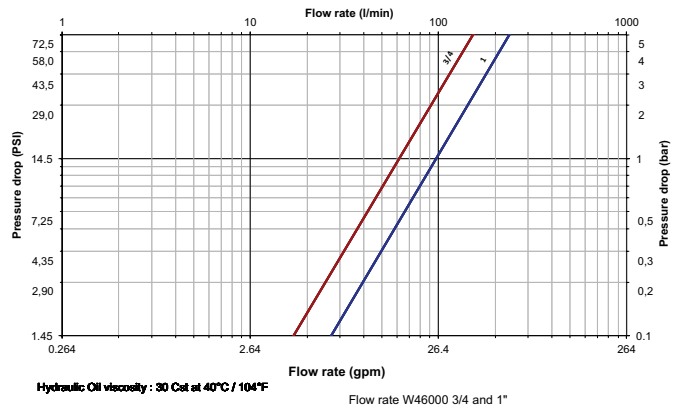

AGRICULTURE

Size (in)	DN/ND	Socket/Female	Socket Dust Plug Only	Coupling Type	Connection	Fig.	Dimensions		
							L1 (mm)	1 (mm)	Hex 1 (mm)
3/4	16	WA4604700	WA4614700	Socket/Female	G 3/4	1	77	M5	33
1	20	WA4605700	WA4615700	Socket/Female	G 1	1	83	M6	40

Size (in)	DN/ND	Socket/Female	Socket Dust Plug Only	Coupling Type	Connection	Fig.	Dimensions			
							L2 (mm)	2 (mm)	Hex 2 (mm)	Hex 3 (mm)
3/4	16	WA4604400	WA4614400	Plug/Male	G 3/4	2	78	G 1" 1/4	46	50
1	20	WA4605400	WA4615400	Plug/Male	G 1	2	83	G 1" 1/4	55	50

REFRIGERANT

W36000 Series Thread-to-Connect



Eaton's W36000 Series is a screw-to-connect quick disconnect coupling. Due to its design and the materials used, the W36000 Series quick disconnect coupling has excellent resistance to mechanical and hydraulic applications where vibration is present. The inner components of sizes 3/4", 1" & 1 1/4" have a robust construction to withstand the harsh application needs. Additionally, the plug sleeve ensures protection of the sealing area upon disconnection.

Product Features

- Designed and manufactured in accordance with Article 4.3 of the European Pressure Equipment Directive PED 2014/68/EU
- Proprietary profile
- Thread-to-connect with double shut-off valving
- Can be connected against 50 bar (725 psi) residual pressure
- Optional dust caps and plugs (PVC or aluminum)
- An alternative version can be offered with a safety feature which minimizes the risk of unscrewing in conditions of heavy vibration
- O-ring indication allows checking that connection is complete (thus guaranteeing full flow)
- Standard body material: Zinc trivalent plated steel
- Standard seal material: NBR

Physical Characteristics

Body Size (in)	Nominal Flow Diameter (mm)	Max. Operating Pressure		Max. Residual Pressure during Connection		Rated Flow*	
		bar	(psi)	bar	(psi)	L/min	(gpm)
1/4	5.3	450	6525	50	725	12	3.17
3/8	7.3	450	6525	50	725	21	5.55
1/2	10.2	400** 250***	5800** 3625***	50	725	43	11.36
3/4	13.0	400	5800	50	725	77	20.34
1	16.9	300	4350	50	725	120	31.70
1 1/4	22.4	300	4350	50	725	300	79.25

* Indicated values refer to a 1 bar / 14.5 psi pressure drop.
 ** Operating pressures apply to BSPP and NPT threads.
 *** For ISO 8434-1 end connections.

Applications & Markets

- Construction
- Agriculture
- Forestry Machinery
- Snow-grooming Machines

Flow Data

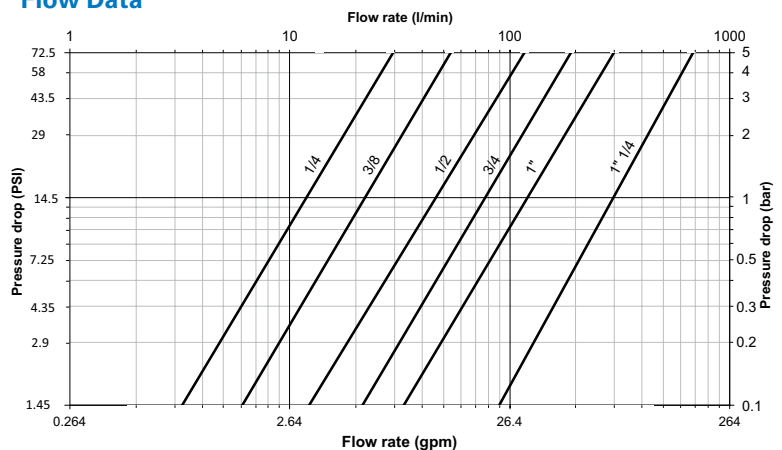

Seal Elastomer Data*

Seal Elastomer	Max. Operation Temperature Range
NBR (Nitrile)	-20°C +100°C / -4°F +212°F

* For reference only, based on Eaton recommended temperatures. Contact Eaton technical support for further information on fluid compatibility.

FLUID TRANSFER
AND HYDRAULIC

PNEUMATIC

SPECIAL APPLICATIONS

DIAGNOSTIC

AGRICULTURE

REFRIGERANT

W36000 Series Thread-to-Connect

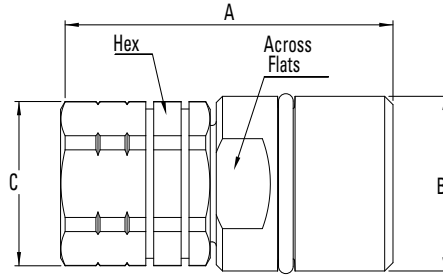

Figure 1

Sockets (Female) with Internal Thread

Part Number*	Body Size	Nominal Flow Diameter	Thread Size* (Female)	BSPP Fig.	Dimensions							Weight					
					A (in)	B (in)	C (in)	Across Flats (in)	Hex (in)	A (mm)	B (mm)	C (mm)	Across Flats (mm)	Hex (mm)	lbs	grams	
WA3601700	¼	5.3	-	¼-19	1	2.28	0.94	0.94	0.87	0.87	58	M24x2	24	22	22	0.26	117
WA3621725	¼	5.3	¼-18	-	1	2.28	0.94	0.94	0.87	0.87	58	M24x2	24	22	22	0.30	138
WA3602725BS	¾	7.3	-	¼-19	1	2.40	1.10	0.94	0.94	0.87	61	M28x2	24	24	22	0.36	163
WA3622725	¾	7.3	¼-18	-	1	2.40	1.10	0.94	0.94	0.87	61	M28x2	24	24	22	0.36	165
WA3602700	¾	7.3	-	¾-19	1	2.40	1.10	0.94	0.94	0.87	61	M28x2	24	24	22	0.34	156
WA3622737	¾	7.3	¾-18	-	1	2.40	1.10	0.94	0.94	0.87	61	M28x2	24	24	22	0.35	158
WA3603737BS	½	10.2	-	¾-19	1	2.84	1.42	1.18	1.61(Hex)	1.06	72	M36x2	30	41(Hex)	27	0.82	370
WA3623737	½	10.2	¾-18	-	1	2.84	1.42	1.18	1.61(Hex)	1.06	72	M36x2	30	41(Hex)	27	0.82	372
WA3603700	½	10.2	-	½-14	1	2.95	1.42	1.18	1.61(Hex)	1.06	75	M36x2	30	41(Hex)	27	0.79	360
WA3623750	½	10.2	½-14	-	1	2.95	1.42	1.18	1.61(Hex)	1.06	75	M36x2	30	41(Hex)	27	0.80	361
WA3604750BS	¾	13	-	½-14	1	3.15	1.65	1.57	1.42	1.42	80	M42x2	40	36	36	1.06	480
WA3624750	¾	13	½-14	-	1	3.15	1.65	1.57	1.42	1.42	80	M42x2	40	36	36	1.07	484
WA3604700	¾	13	-	¾-14	1	3.15	1.65	1.57	1.42	1.42	80	M42x2	40	36	36	1.03	466
WA3624775	¾	13	¾-14	-	1	3.15	1.65	1.57	1.42	1.42	80	M42x2	40	36	36	1.04	472
WA3605775BS	1	16.9	-	¾-14	1	3.78	1.89	1.81	1.65	1.65	96	M48x3	46	42	42	1.62	735
WA3625775	1	16.9	¾-14	-	1	3.78	1.89	1.81	1.65	1.65	96	M48x3	46	42	42	1.63	741
WA3605700	1	16.9	-	1-11	1	3.78	1.89	1.81	1.65	1.65	96	M48x3	46	42	42	1.51	684
WA36257100	1	16.9	1-11 ½	-	1	3.78	1.89	1.81	1.65	1.65	96	M48x3	46	42	42	1.53	694
WA3606700	1 ¼	22.4	-	1 ¼-11	1	4.96	2.76	2.83	2.56	2.56	126	M70x3	72	65	65	4.82	2185
WA36267125	1 ¼	22.4	1 ¼-11 ½	-	1	4.96	2.76	2.83	2.56	2.56	126	M70x3	72	65	65	4.87	2207
WA36067150BS	1 ¼	22.4	-	1 ½-11	1	4.96	2.76	2.83	2.56	2.56	126	M70x3	72	65	65	4.63	2101
WA36267150	1 ¼	22.4	1 ½-11 ½	-	1	4.96	2.76	2.83	2.56	2.56	126	M70x3	72	65	65	4.68	2121

* Alternative end connections upon request.

To obtain connected length of coupling add dimensions A (Fig. 1) and K (Fig. 3) or O (Fig. 4) together.

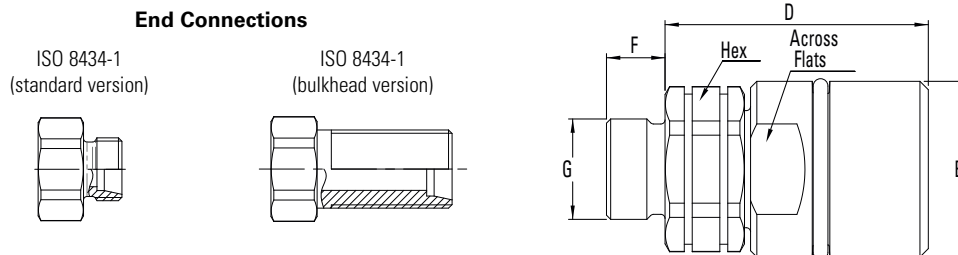

Figure 2

Sockets (Female) with External Thread

Part Number	Body Size	Nominal Flow Diameter	Thread Size* (Male)	Fig.	Dimensions							Weight						
					D (in)	E (in)	F (in)	G (in)	Across Flats (in)	Hex (in)	D (mm)	E (mm)	F (mm)	G (mm)	Across Flats (mm)	Hex (mm)	lbs	grams
WA3633708L	½	10.2	M14x1.5 - 8L	2	2.32	1.42	0.39	0.55	1.61(Hex)	1.06	59	M36x2	10	M14x1.5	41(Hex)	27	0.73	330
WA3633710L			M16x1.5 - 10L	2	2.28	1.42	0.43	0.63	1.61(Hex)	1.06	58	M36x2	11	M16x1.5	41(Hex)	27	0.72	328
WA3633712L			M18x1.5 - 12L	2	2.28	1.42	0.43	0.71	1.61(Hex)	1.06	58	M36x2	11	M18x1.5	41(Hex)	27	0.73	330
WA3633715L			M22x1.5 - 15L	2	2.24	1.42	0.47	0.87	1.61(Hex)	1.06	57	M36x2	12	M22x1.5	41(Hex)	27	0.77	350
WA3633715LBH			M22x1.5 - 15L Bulkhead	2	2.28	1.42	1.50	0.87	1.61(Hex)	1.06	58	M36x2	38	M22x1.5	41(Hex)	27	0.85	385

* Alternative end connections upon request.

** Light L series = working pressure 250 bar/3625 psi max.

To obtain connected length of coupling add dimensions D (Fig. 2) and K (Fig. 3) or O (Fig. 4) together.

W36000 Series Thread-to-Connect

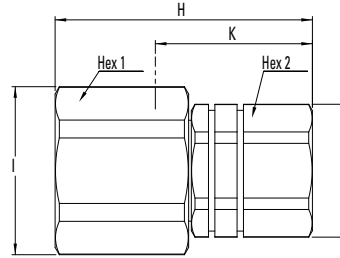

Figure 3

Plugs (Male) with Internal Thread

Part Number	Body Size	Nominal Flow Diameter		Thread Size* (Female)		Dimensions											Weight		
		(in)	(mm)	NPT	BSPP	Fig.	H (in)	I (in)	J (in)	K (in)	Hex 1 (in)	Hex 2 (in)	H (mm)	I (mm)	J (mm)	K (mm)	Hex 1 (mm)	Hex 2 (mm)	lbs
WA3601400	¼	5.3	-	¼-19	3	2.17	1.26	0.94	1.22	1.14	0.87	55	32	24	31	29	22	0.41	184
WA3621425	¼	5.3	-	¼-18	3	2.17	1.26	0.94	1.22	1.14	0.87	55	32	24	31	29	22	0.33	150
WA3602425BS	¾	7.3	-	¼-19	3	2.28	1.38	0.94	1.26	1.26	0.87	58	35	24	32	32	22	0.36	164
WA3622425	¾	7.3	-	¼-18	3	2.28	1.38	0.94	1.26	1.26	0.87	58	35	24	32	32	22	0.37	166
WA3602400	¾	7.3	-	¾-19	3	2.28	1.38	0.94	1.26	1.26	0.87	58	35	24	32	32	22	0.35	158
WA3622437	¾	7.3	-	¾-18	3	2.28	1.38	0.94	1.26	1.26	0.87	58	35	24	32	32	22	0.35	160
WA3603437BS	½	10.2	-	¾-19	3	2.52	1.77	1.18	1.46	1.61	1.06	64	45	30	37	41	27	0.61	276
WA3623437	½	10.2	-	¾-18	3	2.52	1.77	1.18	1.46	1.61	1.06	64	45	30	37	41	27	0.61	278
WA3603400	½	10.2	-	½-14	3	2.60	1.77	1.18	1.57	1.61	1.06	66	45	30	40	41	27	0.60	271
WA3623450	½	10.2	-	½-14	3	2.60	1.77	1.18	1.57	1.61	1.06	66	45	30	40	41	27	0.60	273
WA3604450BS	¾	13.0	-	½-14	3	3.03	1.97	1.57	1.85	1.81	1.42	77	50	40	47	46	36	1.01	456
WA3624450	¾	13.0	-	½-14	3	3.03	1.97	1.57	1.85	1.81	1.42	77	50	40	47	46	36	1.01	460
WA3604400	¾	13.0	-	¾-14	3	3.03	1.97	1.57	1.85	1.81	1.42	77	50	40	47	46	36	0.97	442
WA3624475	¾	13.0	-	¾-14	3	3.03	1.97	1.57	1.85	1.81	1.42	77	50	40	47	46	36	0.99	448
WA3605475BS	1	16.9	-	¾-14	3	3.62	2.36	1.81	2.24	2.17	1.65	92	60	46	57	55	42	1.77	805
WA3625475	1	16.9	-	¾-14	3	3.62	2.36	1.81	2.24	2.17	1.65	92	60	46	57	55	42	1.79	811
WA3605400	1	16.9	-	1-11	3	3.62	2.36	1.81	2.24	2.17	1.65	92	60	46	57	55	42	1.66	751
WA36254100	1	16.9	-	1-11½	3	3.62	2.36	1.81	2.24	2.17	1.65	92	60	46	57	55	42	1.68	761
WA3606400	1¼	22.4	-	1¼-11	3	4.72	3.50	2.83	2.76	3.03	2.56	120	89	72	70	77	65	5.56	2520
WA36264125	1¼	22.4	-	1¼-11½	3	4.72	3.50	2.83	2.76	3.03	2.56	120	89	72	70	77	65	5.60	2542
WA36064150BS	1¼	22.4	-	1½-11	3	4.72	3.50	2.83	2.76	3.03	2.56	120	89	72	70	77	65	5.37	2436
WA36264150	1¼	22.4	-	1½-11½	3	4.72	3.50	2.83	2.76	3.03	2.56	120	89	72	70	77	65	5.41	2456

* Alternative end connections upon request.

To obtain connected length of coupling add dimensions K (Fig. 3) and A (Fig. 1) or D (Fig. 2) together.

End Connections

ISO 8434-1
(standard version)

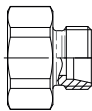

ISO 8434-1
(bulkhead version)

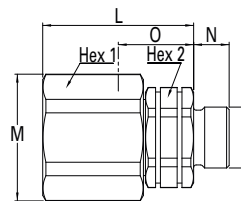
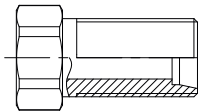

Figure 4

Plugs (Male) with External Thread

Part Number	Body Size	Nominal Flow Diameter		Thread Size* (Male)		Dimensions											Weight			
		(in)	(mm)	ISO 8434-1**	Fig.	L (in)	M (in)	N (in)	O (in)	P (in)	Hex 1 (in)	Hex 2 (in)	L (mm)	M (mm)	N (mm)	O (mm)	P (mm)	Hex 1 (mm)	Hex 2 (mm)	lbs
WA3633408L	½	10.2	M14x1.5 - 8L	4	1.93	1.77	0.39	1.42	0.55	1.61	1.06	49	45	10	36	M14x1.5	41	27	0.56	255
WA3633410L			M16x1.5 - 10L	4	1.93	1.77	0.43	1.42	0.63	1.61	1.06	49	45	11	36	M16x1.5	41	27	0.56	253
WA3633412L			M18x1.5 - 12L	4	1.93	1.77	0.43	1.42	0.71	1.61	1.06	49	45	11	36	M18x1.5	41	27	0.56	255
WA3633415L			M22x1.5 - 15L	4	1.93	1.77	0.47	1.42	0.87	1.61	1.06	49	45	12	36	M22x1.5	41	27	0.61	275
WA3633415LBH			M22x1.5 - 15L Bulkhead	4	1.93	1.77	1.50	1.42	0.87	1.61	1.06	49	45	38	36	M22x1.5	41	27	0.68	310

* Alternative end connections upon request.

** Light L series = working pressure 250 bar/3625 psi max.

To obtain connected length of coupling add dimensions O (Fig. 4) and A (Fig. 1) or D (Fig. 2) together.

FLUID TRANSFER
AND HYDRAULIC

PNEUMATIC

SPECIAL APPLICATIONS

DIAGNOSTIC

AGRICULTURE

REFRIGERANT

W36000 Series Thread-to-Connect

FLUID TRANSFER
AND HYDRAULIC

Dust Plugs and Dust Caps

Body Size (in)	Socket Dust Plug Part Number		Plug Dust Cap Part Number	
	Anodized Aluminum	PVC	Anodized Aluminum	PVC
¼	-	WP3611700	-	WP3611400
⅜	-	WP3612700	-	WP3612400
½	WD3613700	WP3613700	WD3613400	WP3613400
¾	-	WP3614700	-	WP3614400
1	-	WP3615700	-	WP3615400
1 ¼	-	WP3616700	-	WP3616400

For installation instructions, please contact your Eaton sales representative



Metal Socket Dust Plug



Metal Plug Dust Cap



PVC Socket Dust Plug



PVC Plug Dust Cap

PNEUMATIC

SPECIAL APPLICATIONS

Seal Kit for Servicing Sockets (Female)

Body Size (in)	Seal & Back-up Ring Kit*	NBR seals & PTFE back-up rings
	Part Number	
¼	WG3601700	10 seals + 10 back-up rings
⅜	WG3602700	10 seals + 10 back-up rings
½	WG3603700	10 seals + 10 back-up rings
¾	WG3604700	5 seals + 5 back-up rings
1	WG3605700	5 seals + 5 back-up rings
1 ½	WG3606700	1 seal + 1 back-up ring

* The valve seal is not included in our repair kits

DIAGNOSTIC

AGRICULTURE

REFRIGERANT

GA90090 Series



Eaton's high pressure hydraulic coupling GA90090 was engineered to perform in applications that require the highest level of performance. Working pressure of up to 420 bar (6,000psi) in all sizes. One of the most demanding applications is the drill hammer used in construction.

Product Features

- Maximum working pressure up to 420 bar [6000 psi] in all sizes
- Available in size -8, -10, and -12
- Available thread configurations: Metric, UN, and BSP
- Self-sealing features guarantee minimum air inclusion and loss of fluid
- Connection via adapter
- Detachable under pressure
- Long lifetime in dynamic applications
- Works in applications where higher pressures are needed
- Exceeds the requirements of ISC7241/1
- Standard model available in Zinc plated steel

Applications & Markets

- High-pressure hydraulic systems and fluid transfer used in the construction, agriculture and forestry markets
- Dynamic hydraulic applications like the drilling hammer

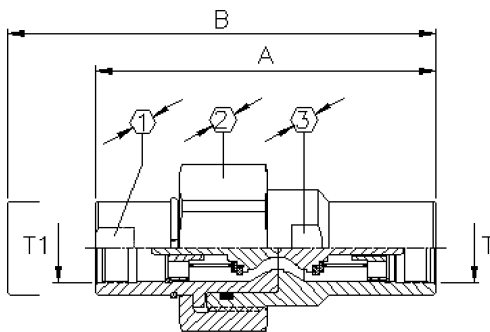

Connected Coupling

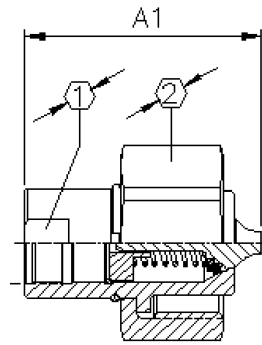

Male Half

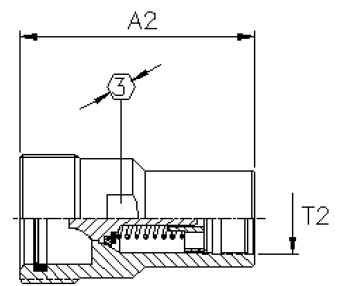

Female Half

Metric Thread

Size	DN	Coupling	Thread	A	B	Hex 1	Hex 2	Hex 3
			(T1=T2)	(mm)	(mm)	(mm)	(mm)	(mm)
-8	12	GA90090-8	M22x1,5	89.1	105	27	41	27
-12	16	GA90090-12	M30x1,5	143.6	183	36	65	46
-16	20	GA90090-16	M38x1,5	163.7	196.7	50	75	55

Size	DN	Male Half	Female Half	A1	A2
				(mm)	(mm)
-8	12	GA90092-8	GA90091-8	45.7	59.4
-12	16	GA90092-12	GA90091-12	76.8	96.7
-16	20	GA90092-16	GA90091-16	81.7	115.0

UNF-Thread*

Size	DN	Coupling	Thread	A	B	Hex 1	Hex 2	Hex 3
			(T1=T2)	(mm)	(mm)	(mm)	(mm)	(mm)
-8	12	GA90762-8	7/8-14UNF-2B	93.1	109	27	41	27
-12	16	GA90762-12	1 3/8-12UNF-2B	163.7	196.7	36	65	46

Size	DN	Male Half	Female Half	A1	A2
				(mm)	(mm)
-8	12	GA90764-8	GA90763-8	47.7	61.4
-12	16	GA90764-12	GA90763-12	88.8	106.7

*Thread according to SAE J1926-1 (ISO 11926-1)

BSP-Thread

Size	DN	Coupling	Thread	A	B	Hex 1	Hex 2	Hex 3
			(T1=T2)	(mm)	(mm)	(mm)	(mm)	(mm)
-8	12	GA90767-8	G 1/2"-14	99.1	115	27	41	27
-12	16	GA90767-12-16	G 1"-11	158.8	188.7	36	65	46
-16	20	GA90767-16-20	G 1 1/4"-11	163.7	196.7	50	75	55

Size	DN	Male Half	Female Half	A1	A2
				(mm)	(mm)
-8	12	GA90767-8	GA90768-8	50.7	64.4
-12	16	GA90767-12-16	GA90768-12-16	84.4	104.3
-16	20	GA90767-16-20	GA90768-16-20	81.7	115.0

W6000 Series (Steel) Thread-to-Connect



Eaton's W6000 Series steel quick disconnect coupling is a thread-to-connect with a rugged construction. It remains the series users refer to when it deals with severe hydraulic applications, such as construction and mining. The design and materials used give this quick disconnect coupling resistance to heavy mechanical loads. Most common examples are ram loads, hydraulic shocks and severe pulsating pressures.

Product Features

- Proprietary profile
- Thread-to-connect with double shut-off valving
- Optional dust caps and plugs (made of anodized aluminum)
- Can be connected under residual pressure up to 30 bar with standard seal, up to 150 bar with PU seal
- Standard body material: Zinc trivalent plated steel
- Standard seal material: NBR, FKM, EPDM

European Pressure Equipment Directive

Couplings with nominal diameters up to and including 25 mm are designed and manufactured under Article 4.3 of the European Pressure Equipment Directive PED 2014/68/EU. Couplings with nominal diameters greater than 25 mm are designed and manufactured in accordance with the stipulations of Module A of the European Pressure Equipment Directive PED 2014/68/EU. They should not be used to convey unstable gases.

Group 1 = Hazardous media / Group 2 = Other media

Physical Characteristics

Body Size (in)	Nominal Flow Diameter (mm)	Max. Operating Pressure*				Maximum Residual Pressure during Connection***		Rated Flow**		Fluid Loss ml-cc.
		(bar)	(psi)	(bar)	(psi)	(bar)	(psi)	(lpm)	(gpm)	
¼	5.7	1,100	15,950	1,100	15,950	30	435	11.6	3.06	1.1
⅜	7.6	750	10,875	750	10,875	30	435	16.7	4.41	1.9
½	10.3	750	10,875	750	10,875	30	435	25.5	6.74	2.8
¾	14.2	650	9,425	650	9,425	50	725	55	14.53	5.8
1	16.5	450	6,525	450	6,525	30	435	87	22.98	10.9
1¼	20.5	450	6,525	450	6,525	30	435	140	36.98	26.9
1½	25.8	300	4,350	38	550	30	435	208	54.95	37.5
2	34.7	300	4,350	28	405	30	435	357	94.30	81

* For pulsating pressures when disconnected apply a multiplier of 0.5

** Indicated values refer to a 1 bar/14.5 psi pressure drop.

*** When connecting under pressure, the socket nut thread must be lubricated.

Applications & Markets

- Construction
- Oil & Gas
- Material Handling
- All industrial and severe applications
- Systems subject to heavy mechanical loads, high pressures

Flow Data

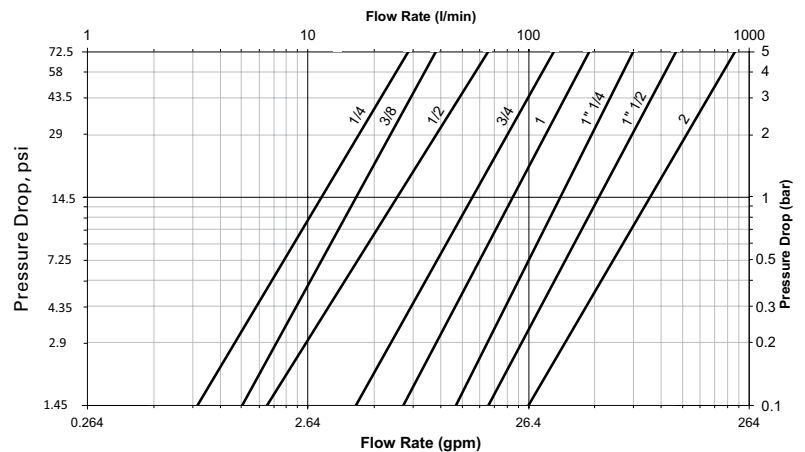

Test Fluid: Oil viscosity 30 cSt at 40°C/104°F

Seal Elastomer Data*

Seal Elastomer	Max. Operation Temperature Range
NBR (Nitrile)	-20°C +100°C/-4°F +212°F
FKM	-20°C +200°C/-4°F +392°F
EPDM (Ethylene-Propylene)	-40°C +150°C/-40°F +302°F

* For reference only, based on Eaton recommended temperatures.

Contact Eaton technical support for further information on fluid compatibility.

W6000 Series (Steel) Thread-to-Connect

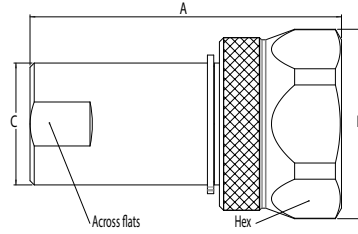

Figure 1

Sockets (Female)

Part Number	NBR	FKM	EPDM	Body Size (in)	Nominal Flow Diameter (mm)	Thread Size* (Female)			Dimensions								Weight			
						NPT	BSPB	Metric	Fig. A (in)	B (in)	C (in)	Across Flats (in)	Hex (in)	A (mm)	B (mm)	C (mm)	Across Flats (mm)	Hex (mm)	lbs	grams
WA0601700	WA06017V0	WA06017E0	¼	5.7	-	¼-19	-	1	2.09	1.38	0.83	0.75	1.26	53	35	21	19	32	0.32	144
WA0621700	WA06217V0	WA06217E0	¼	5.7	¼-18	-	-	1	2.09	1.38	0.83	0.75	1.26	53	35	21	19	32	0.32	144
WA0602700	WA06027V0	WA06027E0	⅜	7.6	-	⅜-19	-	1	2.56	1.50	0.98	0.90	1.38	65	38	25	23	35	0.48	217
WA0622700	WA06227V0	WA06227E0	⅜	7.6	⅜-18	-	-	1	2.56	1.50	0.98	0.90	1.38	65	38	25	23	35	0.48	217
WA0603700	WA06037V0	WA06037E0	½	10.3	-	½-14	-	1	2.91	1.77	1.14	1.06	1.61	74	45	29	27	41	0.71	320
WA0623700	WA06237V0	WA06237E0	½	10.3	½-14	-	-	1	2.91	1.77	1.14	1.06	1.61	74	45	29	27	41	0.71	320
WA0633700	WA06337V0	WA06337E0	½	10.3	-	-	M22x1.5	1	2.91	1.77	1.14	1.06	1.61	74	45	29	27	41	0.71	320
WA0604700	WA06047V0	WA06047E0	¾	14.2	-	¾-14	-	1	3.58	2.16	1.50	1.38	1.97	91	55	38	35	50	1.32	600
WA0624700	WA06247V0	WA06247E0	¾	14.2	¾-14	-	-	1	3.58	2.16	1.50	1.38	1.97	91	55	38	35	50	1.32	600
WA0605700	WA06057V0	WA06057E0	1	16.5	-	1-11	-	1	4.05	2.72	1.81	1.61	2.56	103	69	46	41	65	2.41	1092
WA0625700	WA06257V0	WA06257E0	1	16.5	1-11½	-	-	1	4.05	2.72	1.81	1.61	2.56	103	69	46	41	65	2.41	1092
WA0635700	WA06357V0	WA06357E0	1	16.5	-	-	M33x1.5	1	4.05	2.72	1.81	1.61	2.56	103	69	46	41	65	2.41	1092
WA0606700	WA06067V0	WA06067E0	1¼	20.5	-	1¼-11	-	1	5.71	3.50	2.36	2.16	3.03	145	89	60	55	77	6.13	2780
WA0626700	WA06267V0	WA06267E0	1¼	20.5	1¼-11½	-	-	1	5.71	3.50	2.36	2.16	3.03	145	89	60	55	77	6.13	2780
WA0607700	WA06077V0	WA06077E0	1½	25.8	-	1½-11	-	1	6.81	3.94	2.64	2.48	3.46	173	100	67	63	88	9.26	4200
WA0627700	WA06277V0	WA06277E0	1½	25.8	1½-11½	-	-	1	6.81	3.94	2.64	2.48	3.46	173	100	67	63	88	9.26	4200
WA0609700	WA06097V0	WA06097E0	2	34.7	-	2-11	-	1	8.07	4.60	3.07	2.80	4.13	205	117	78	71	105	14.64	6640
WA0629700	WA06297V0	WA06297E0	2	34.7	2-11½	-	-	1	8.07	4.60	3.07	2.80	4.13	205	117	78	71	105	14.64	6640

* Alternative end connections available upon request.

To obtain connected length of coupling add dimensions A (Fig.1) and G (Fig. 2) together.

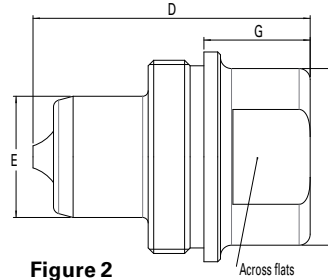

Figure 2

Plugs (Male)

Part Number	NBR	FKM	EPDM	Body Size (in)	Nominal Flow Diameter (mm)	Thread Size* (Female)			Dimensions								Weight			
						NPT	BSPB	Metric	Fig. D (in)	E (in)	F (in)	G (in)	Across Flats (in)	D (mm)	E (mm)	F (mm)	G (mm)	Across Flats (mm)	lbs	grams
WA0601400	WA06014V0	WA06014E0	¼	5.7	-	¼-19	-	2	1.38	0.59	0.90	0.45	0.75	35	15	23	11.5	19	0.16	71
WA0621400	WA06214V0	WA06214E0	¼	5.7	¼-18	-	-	2	1.38	0.59	0.90	0.45	0.75	35	15	23	11.5	19	0.16	71
WA0602400	WA06024V0	WA06024E0	⅜	7.6	-	⅜-19	-	2	1.65	0.75	1.02	0.52	0.90	42	19	26	13	23	0.23	104
WA0622400	WA06224V0	WA06224E0	⅜	7.6	⅜-18	-	-	2	1.65	0.75	1.02	0.52	0.90	42	19	26	13	23	0.23	104
WA0603400	WA06034V0	WA06034E0	½	10.3	-	½-14	-	2	1.97	0.87	1.26	0.77	1.06	50	22	32	19.5	27	0.36	165
WA0623400	WA06234V0	WA06234E0	½	10.3	½-14	-	-	2	1.97	0.87	1.26	0.77	1.06	50	22	32	19.5	27	0.36	165
WA0633400	WA06334V0	WA06334E0	½	10.3	-	-	M22x1.5	2	1.97	0.87	1.26	0.77	1.06	50	22	32	19.5	27	0.36	165
WA0604400	WA06044V0	WA06044E0	¾	14.2	-	¾-14	-	2	2.48	1.14	1.65	1.02	1.38	63	29	42	26	35	0.84	382
WA0624400	WA06244V0	WA06244E0	¾	14.2	¾-14	-	-	2	2.48	1.14	1.65	1.02	1.38	63	29	42	26	35	0.84	382
WA0605400	WA06054V0	WA06054E0	1	16.5	-	1-11	-	2	2.80	1.42	1.89	1.14	1.61	71	36	48	29	41	1.29	585
WA0625400	WA06254V0	WA06254E0	1	16.5	1-11½	-	-	2	2.80	1.42	1.89	1.14	1.61	71	36	48	29	41	1.29	585
WA0635400	WA06354V0	WA06354E0	1	16.5	-	-	M33x1.5	2	2.80	1.42	1.89	1.14	1.61	71	36	48	29	41	1.29	585
WA0606400	WA06064V0	WA06064E0	1¼	20.5	-	1¼-11	-	2	3.82	2.00	2.36	1.45	2.16	97	50.9	60	37	55	3.22	1460
WA0626400	WA06264V0	WA06264E0	1¼	20.5	1¼-11½	-	-	2	3.82	2.00	2.36	1.45	2.16	97	50.9	60	37	55	3.22	1460
WA0607400	WA06074V0	WA06074E0	1½	25.8	-	1½-11	-	2	4.29	2.24	2.64	1.22	2.48	109	56.9	67	31	63	4.50	2040
WA0627400	WA06274V0	WA06274E0	1½	25.8	1½-11½	-	-	2	4.29	2.24	2.64	1.22	2.48	109	56.9	67	31	63	4.50	2040
WA0609400	WA06094V0	WA06094E0	2	34.7	-	2-11	-	2	5.08	2.73	3.07	1.32	2.80	129	69.4	78	33	71	7.05	3200
WA0629400	WA06294V0	WA06294E0	2	34.7	2-11½	-	-	2	5.08	2.73	3.07	1.32	2.80	129	69.4	78	33	71	7.05	3200

* Alternative end connections available upon request.

To obtain connected length of coupling add dimensions A (Fig.1) and G (Fig. 2) together.

FLUID TRANSFER
AND HYDRAULIC

PNEUMATIC

SPECIAL APPLICATIONS

DIAGNOSTIC

AGRICULTURE

REFRIGERANT

W6000 Series (Steel) Thread-to-Connect

Dust Plugs and Dust Caps

Body Size	Socket Dust Plug Part Number	Plug Dust Cap Part Number
(in)	Anodized Aluminum	Anodized Aluminum
¼	WD0611700	WD0611400
⅜	WD0612700	WD0612400
½	WD0613700	WD0613400
¾	WD0614700	WD0614400
1	WD0615700	WD0615400
1¼	WD0616700	WD0616400
1½	WD0617700	WD0617400
2	WD0619700	WD0619400

Seal kit for servicing sockets (Female)

Body Size (in)	Seal & Back-up Ring Kit*		Qty
	NBR seals & PTFE back-up rings	FKM seals & PTFE back-up rings	
1/4	WG0601700	WG06017V0	50 O-rings + 50 Backup rings
3/8	WG0602700	WG06027V0	50 O-rings + 50 Backup rings
1/2	WG0603700	WG06037V0	50 O-rings + 50 Backup rings
3/4	WG0604700	WG06047V0	50 O-rings + 50 Backup rings
1	WG0605700	WG06057V0	50 O-rings + 50 Backup rings
1 1/4	WG0606700	WG06067V0	15 O-rings + 15 Backup rings
1 1/2	WG0607700	WG06077V0	15 O-rings + 15 Backup rings
2	WG0609700	WG06097V0	15 O-rings + 15 Backup rings

*The valve seal is not included in our repair kits

EPDM seals (-40°C/+150°C) are also available but kit part number doesn't exist. Please ask our technical support in case you need this compound.

FLUID TRANSFER
AND HYDRAULIC

PNEUMATIC

SPECIAL APPLICATIONS

DIAGNOSTIC

AGRICULTURE

REFRIGERANT

W6000 Series (Stainless Steel) Thread-to-Connect



Eaton's W6000 Series stainless steel quick disconnect coupling is a thread-to-connect with a rugged construction. This quick disconnect coupling utilizes 1.4418 grade stainless steel, which guarantees the same mechanical resistance as the steel version while offering excellent resistance in corrosive environments. It remains the coupling of choice in offshore oil & gas applications but also covers a wide range of alternative hydraulic applications.

Product Features

- Proprietary profile
- Thread-to-connect with double shut-off valving
- Resistance to heavy mechanical loads (hydraulic shocks, severe pulsating pressures, etc.).
- Optional dust caps and plugs (made of anodized aluminum)
- Can be connected under residual pressure
- Standard seal material: FKM, EPDM
- Standard body material: Stainless steel 1.4418 (1.4404 AISI 316L stainless steel available on request at lower operating pressures). Please contact Eaton technical support for further information

European Pressure Equipment Directive

Couplings with nominal diameters up to and including 25 mm are designed and manufactured under Article 4.3 of the European Pressure Equipment Directive PED 2014/68/EU. Couplings with nominal diameters greater than 25 mm are designed and manufactured in accordance with the stipulations of Module A of the European Pressure Equipment Directive PED 2014/68/EU. They should not be used to convey unstable gases.

Group 1 = Hazardous media /
Group 2 = Other media

Applications & Markets

- Construction
- Oil & Gas
- Material Handling
- All industrial and severe applications
- Systems subject to heavy mechanical loads, high pressures

Physical Characteristics

Body Size (in)	Nominal Flow Diameter (mm)	Max. Operating Pressure*				Maximum Residual Pressure during Connection***		Rated Flow**		Fluid Loss ml-cc.
		Non hazardous liquids & gases Group 2		Hazardous liquids & gases Group 1		(bar)	(psi)	(lpm)	(gpm)	
¼	5.7	1100	15,950	1100	15,950	30	435	11.6	3.06	1.1
⅜	7.6	750	10,875	750	10,875	30	435	16.7	4.41	1.9
½	10.3	750	10,875	750	10,875	30	435	25.5	6.74	2.8
¾	14.2	650	9,425	650	9,425	50	725	55	14.53	5.8
1	16.5	450	6,525	450	6,525	30	435	87	22.98	10.9
1¼	20.5	450	6,525	450	6,525	30	435	140	36.98	26.9
1½	25.8	300	4,350	38	550	30	435	208	54.95	37.5
2	34.7	300	4,350	28	405	30	435	357	94.30	81.0

* For pulsating pressures when disconnected apply a multiplier of 0.5

** Indicated values refer to a 1 bar/14.5 psi pressure drop.

*** When connecting under pressure, the socket nut thread must be lubricated.

Flow Data

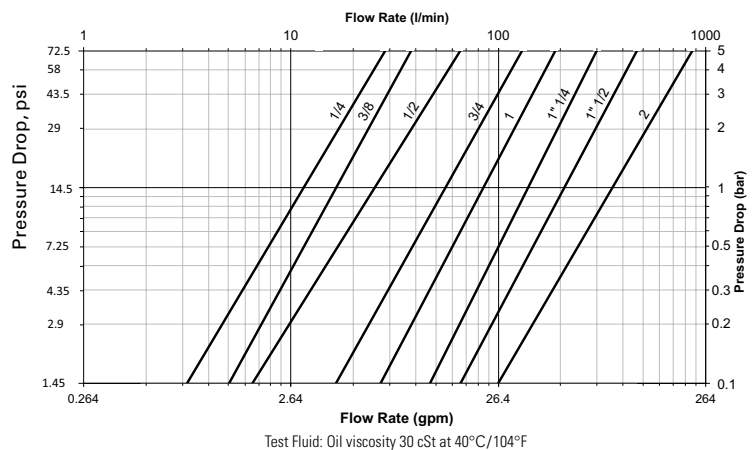

Seal Elastomer Data*

Seal Elastomer	Max. Operation Temperature Range
FKM	-20°C +200°C/-4°F +392°F
EPDM (Ethylene-Propylene)	-40°C +150°C/-40°F +302°F

* For reference only, based on Eaton recommended temperatures.

Contact Eaton technical support for further information on fluid compatibility.

W6000 Series (Stainless Steel) Thread-to-Connect

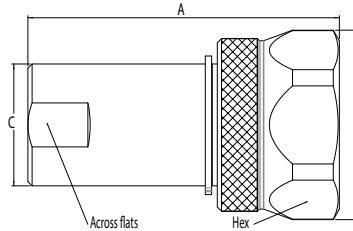

Figure 1

Sockets (Female)

Part Number*	Body Size	Nominal Flow Diameter	Thread Size**	Dimensions												Weight		
				(in)	(mm)	NPT	BSPP	Fig. A	B	C	Across Flats	Hex	A	B	C	Across Flats	Hex	lbs
FKM	EPDM	(in)	(mm)	NPT	BSPP	Fig. A	B	C	Across Flats	Hex	A	B	C	Across Flats	Hex	lbs	grams	
WV06017V0	WV06017E0	¼	5.7	-	¼-19	1	2.09	1.38	0.83	0.75	1.26	53	35	21	19	32	0.32	144
WV06217V0	WV06217E0	¼	5.7	¼-18	-	1	2.09	1.38	0.83	0.75	1.26	53	35	21	19	32	0.32	144
WV06027V0	WV06027E0	⅜	7.6	-	⅜-19	1	2.56	1.50	0.98	0.90	1.38	65	38	25	23	35	0.48	217
WV06227V0	WV06227E0	⅜	7.6	⅜-18	-	1	2.56	1.50	0.98	0.90	1.38	65	38	25	23	35	0.48	217
WV06037V0	WV06037E0	½	10.3	-	½-14	1	2.91	1.77	1.14	1.06	1.61	74	45	29	27	41	0.71	320
WV06237V0	WV06237E0	½	10.3	½-14	-	1	2.91	1.77	1.14	1.06	1.61	74	45	29	27	41	0.71	320
WV06047V0	WV06047E0	¾	14.2	-	¾-14	1	3.58	2.16	1.50	1.38	1.97	91	55	38	35	50	1.32	600
WV06247V0	WV06247E0	¾	14.2	¾-14	-	1	3.58	2.16	1.50	1.38	1.97	91	55	38	35	50	1.32	600
WV06057V0	WV06057E0	1	16.5	-	1-11	1	4.05	2.72	1.81	1.61	2.56	103	69	46	41	65	2.41	1092
WV06257V0	WV06257E0	1	16.5	1-11 ½	-	1	4.05	2.72	1.81	1.61	2.56	103	69	46	41	65	2.41	1092
WV06067V0	WV06067E0	1 ¼	20.5	-	1 ¼-11	1	5.71	3.50	2.36	2.16	3.03	145	89	60	55	77	6.13	2780
WV06267V0	WV06267E0	1 ¼	20.5	1 ¼-11 ½	-	1	5.71	3.50	2.36	2.16	3.03	145	89	60	55	77	6.13	2780
WV06077V0	WV06077E0	1 ½	25.8	-	1 ½-11	1	6.81	3.94	2.64	2.48	3.46	173	100	67	63	88	9.26	4200
WV06277V0	WV06277E0	1 ½	25.8	1 ½-11 ½	-	1	6.81	3.94	2.64	2.48	3.46	173	100	67	63	88	9.26	4200
WV06097V0	WV06097E0	2	34.7	-	2-11	1	8.07	4.60	3.07	2.80	4.13	205	117	78	71	105	14.64	6640
WV06297V0	WV06297E0	2	34.7	2-11 ½	-	1	8.07	4.60	3.07	2.80	4.13	205	117	78	71	105	14.64	6640

* 1.4404 AISI 316L stainless steel available on request. Please contact Eaton technical support for further information.

** Alternative end connections available upon request.

To obtain connected length of coupling add dimensions A (Fig.1) and G (Fig. 2) together.

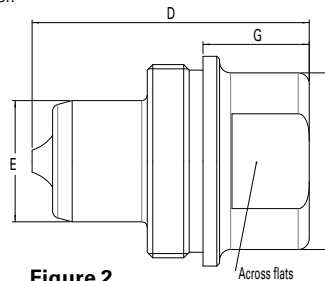

Figure 2

Plugs (Male)

Part Number*	Body Size	Nominal Flow Diameter	Thread Size**	Dimensions												Weight		
				(in)	(mm)	NPT	BSPP	Fig. D	E	F	G	Across Flats	D	E	F	G	Across Flats	lbs
FKM	EPDM	(in)	(mm)	NPT	BSPP	Fig. D	E	F	G	Across Flats	D	E	F	G	Across Flats	lbs	grams	
WV06014V0	WV06014E0	¼	5.7	-	¼-19	2	1.38	0.59	0.90	0.45	0.75	35	15	23	11.5	19	0.16	71
WV06214V0	WV06214E0	¼	5.7	¼-18	-	2	1.38	0.59	0.90	0.45	0.75	35	15	23	11.5	19	0.16	71
WV06024V0	WV06024E0	⅜	7.6	-	⅜-19	2	1.65	0.75	1.02	0.52	0.90	42	19	26	13	23	0.23	104
WV06224V0	WV06224E0	⅜	7.6	⅜-18	-	2	1.65	0.75	1.02	0.52	0.90	42	19	26	13	23	0.23	104
WV06034V0	WV06034E0	½	10.3	-	½-14	2	1.97	0.87	1.26	0.77	1.06	50	22	32	19.5	27	0.36	165
WV06234V0	WV06234E0	½	10.3	½-14	-	2	1.97	0.87	1.26	0.77	1.06	50	22	32	19.5	27	0.36	165
WV06044V0	WV06044E0	¾	14.2	-	¾-14	2	2.48	1.14	1.65	1.02	1.38	63	29	42	26	35	0.84	382
WV06244V0	WV06244E0	¾	14.2	¾-14	-	2	2.48	1.14	1.65	1.02	1.38	63	29	42	26	35	0.84	382
WV06054V0	WV06054E0	1	16.5	-	1-11	2	2.80	1.42	1.89	1.14	1.61	71	36	48	29	41	1.29	585
WV06254V0	WV06254E0	1	16.5	1-11 ½	-	2	2.80	1.42	1.89	1.14	1.61	71	36	48	29	41	1.29	585
WV06064V0	WV06064E0	1 ¼	20.5	-	1 ¼-11	2	3.82	2.00	2.36	1.45	2.16	97	50.9	60	37	55	3.22	1460
WV06264V0	WV06264E0	1 ¼	20.5	1 ¼-11 ½	-	2	3.82	2.00	2.36	1.45	2.16	97	50.9	60	37	55	3.22	1460
WV06074V0	WV06074E0	1 ½	25.8	-	1 ½-11	2	4.29	2.24	2.64	1.22	2.48	109	56.9	67	31	63	4.50	2040
WV06274V0	WV06274E0	1 ½	25.8	1 ½-11 ½	-	2	4.29	2.24	2.64	1.22	2.48	109	56.9	67	31	63	4.50	2040
WV06094V0	WV06094E0	2	34.7	-	2-11	2	5.08	2.73	3.07	1.32	2.80	129	69.4	78	33.5	71	7.05	3200
WV06294V0	WV06294E0	2	34.7	2-11 ½	-	2	5.08	2.73	3.07	1.32	2.80	129	69.4	78	33.5	71	7.05	3200

* 1.4404 AISI 316L stainless steel available on request. Please contact Eaton technical support for further information.

** Alternative end connections available upon request.

To obtain connected length of coupling add dimensions A (Fig.1) and G (Fig. 2) together.

W6000 Series (Stainless Steel) Thread-to-Connect

Dust Plugs and Dust Caps

Body Size	Socket Dust Plug Part Number	Plug Dust Cap Part Number
(in)	Anodized Aluminum	Anodized Aluminum
1/4	WD0611700	WD0611400
3/8	WD0612700	WD0612400
1/2	WD0613700	WD0613400
3/4	WD0614700	WD0614400
1	WD0615700	WD0615400
1 1/4	WD0616700	WD0616400
1 1/2	WD0617700	WD0617400
2	WD0619700	WD0619400

Seal kit for servicing sockets (Female)

Body Size	Seal & Back-up Ring Kit*		Qty
(in)	NBR seals & PTFE back-up rings	FKM seals & PTFE back-up rings	
1/4	WG0601700	WG06017V0	50 O-rings + 50 Backup rings
3/8	WG0602700	WG06027V0	50 O-rings + 50 Backup rings
1/2	WG0603700	WG06037V0	50 O-rings + 50 Backup rings
3/4	WG0604700	WG06047V0	50 O-rings + 50 Backup rings
1	WG0605700	WG06057V0	50 O-rings + 50 Backup rings
1 1/4	WG0606700	WG06067V0	15 O-rings + 15 Backup rings
1 1/2	WG0607700	WG06077V0	15 O-rings + 15 Backup rings
2	WG0609700	WG06097V0	15 O-rings + 15 Backup rings

*The valve seal is not included in our repair kits

EPDM seals (-40°C/+150°C) are also available but kit part number doesn't exist.
Please ask our technical support in case you need this compound.

FLUID TRANSFER
AND HYDRAULIC

PNEUMATIC

SPECIAL APPLICATIONS

DIAGNOSTIC

AGRICULTURE

REFRIGERANT

HP3 Series



Eaton's HP3 Series Hydraulic Jack/Enerpac Interchange is designed for high-pressure applications up to 700 bar (10,000 psi).

Product Features

- Thread together design
- 700 bar (10,000 psi) operating pressure
- Ball valve
- Seal material: Buna-N
- Body material: High-resistance carbon steel with zinc trivalent chromate plating

Applications & Markets

- Hydraulic jack
- Portable hydraulic rams

Physical Characteristics

Body Size (in)	Max. Operating Pressure (Static) Connected		Min. Burst Pressure Connected		Rated Flow	
	(bar)	(psi)	(bar)	(psi)	(lpm)	(gpm)
3/8	700	10,000	2200	31,900	23	6

* Connect and disconnect under pressure not allowed

Dimensions

Part Number	Coupling Type	Body Size	Port Size	Thread	Type	Fig.	Dimensions					
							A	B	Hex			
							mm	(in)	mm	(in)	mm	(in)
HP3SB37M	Socket/Female	3/8	3/8	3/8-18	Male NPT	1	72.2	(2.84)	35.0	(1.38)	24	.94
HP3PB37F	Plug/Male	3/8	3/8	3/8-18	Female NPT	2	40.0	(1.57)	35.0	(1.38)	32	1.26

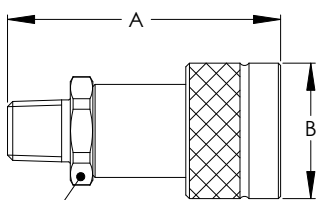

Figure 1

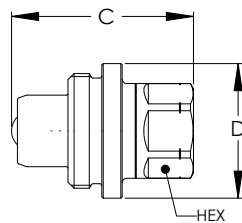

Figure 2

Dust Caps and Dust Plugs

Body Size	Dust Cap	Dust Plug
3/8	WA5612400	WA5612700



W56000 Series



Eaton's W56000 Series is a screw to connect coupling designed to operate at pressures exceeding 10,000 psi or 700 bar. Rugged design makes these couplings suitable for hydraulic jacks and lift loading.

Product Features

- Screw to connect double shut off with poppet valve
- Designed and manufactured under Article 4.3 of the European Pressure Equipment Directive PED 2014/68/EU.
- Interchanges with other couplings with the same profile
- Standard body material: Zinc trivalent plated steel
- Standard seal material: Buna-N

Physical Characteristics

Coupling Size (in)	DN/ND	Max. Operating Pressure		Min. Burst Pressure		Rated Flow		Air Inclusion
		(bar)	(psi)	(bar)	(psi)	(lpm)	(gpm)	ml max
¼	5.7	700	10,000	2,800	40,000	11	2.9	1.1
⅜	7.6	700	10,000	2,800	40,000	16	4.2	1.7

Applications & Markets

- Hydraulic Jacks, Lifts
- Emergency Rescue Equipment

Flow Data

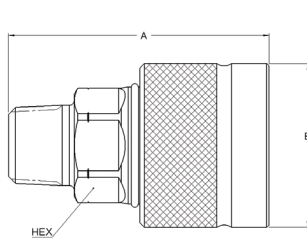
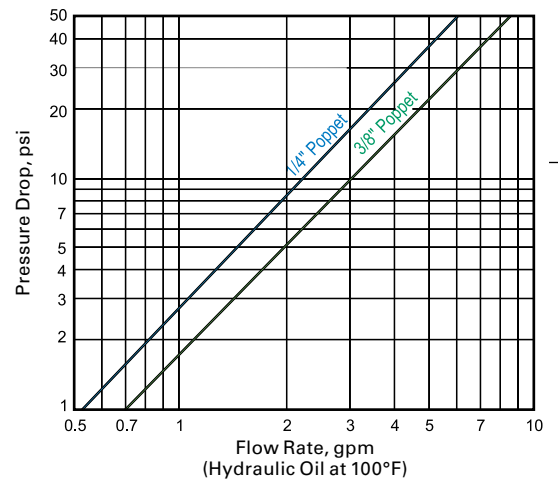

Figure 1

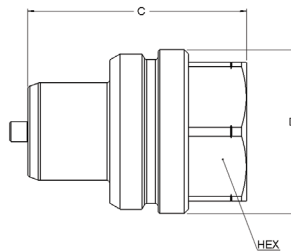

Figure 2

Part Number	DN/ND	Body Size	Coupling Type	Connection	Fig.	Dimensions					
						A	B	Hex	A	B	Hex
WA5651700	5.7	¼	Socket/Female	¼ NPT Male	1	2.44	1.12	.87	62	28.5	22
WA5652700	7.6	⅜	Socket/Female	⅜ NPT Male	1	2.19	1.38	.87	55.6	35	22

Part Number	DN/ND	Socket/Female	Coupling Type	Connection	Fig.	Dimensions					
						C	D	Hex	C	D	Hex
WA5651400	5.7	¼	Plug/Male	¼ NPT Female	2	1.26	1.10	.75	32	28	19
WA5652400	7.6	⅜	Plug/Male	⅜ NPT Female	2	1.65	1.26	1.06	42	32	27

Dust Caps and Dust Plugs

Body Size	Dust Cap	Dust Plug
¼	WA5611400	WA5611700
⅜	WA5612400	WA5612700



FLUID TRANSFER AND HYDRAULIC

PNEUMATIC

SPECIAL APPLICATIONS

DIAGNOSTIC

AGRICULTURE

REFRIGERANT

FD35 Series 10,000 psi Ball Latch



Eaton's FD35 Series ball latch has a greater surface contact area for long surface life in rugged high pressure applications. The maximum operating pressure is 10,000 psi.

Product Features

- Safety sleeve lock prevents accidental disconnection
- Heavy duty back-up ring prevents O-Ring extrusion
- Heat-treated and plated steel for greater wear and corrosion resistance
- Self-sealing poppet valves provide excellent high-and low-pressure sealing
- Standard seal material: FKM
- Standard body material: High-resistance carbon steel with Zinc trivalent plating

Physical Characteristics

Body Size	Max. Operating Pressure		Min. Burst Pressure		Vacuum Connected Only	Rated Flow		Air Inclusion	Fluid Loss
	(bar)	(psi)	(bar)	(psi)		(lpm)	(gpm)		
3/8"	700	10,000	2,800	40,000	28	8	2	0.50	0.50

Applications & Markets

- 10,000 psi Hydraulic Applications
- Hydraulic Tool
- Hydraulic Ram and Work Loading

Flow Data

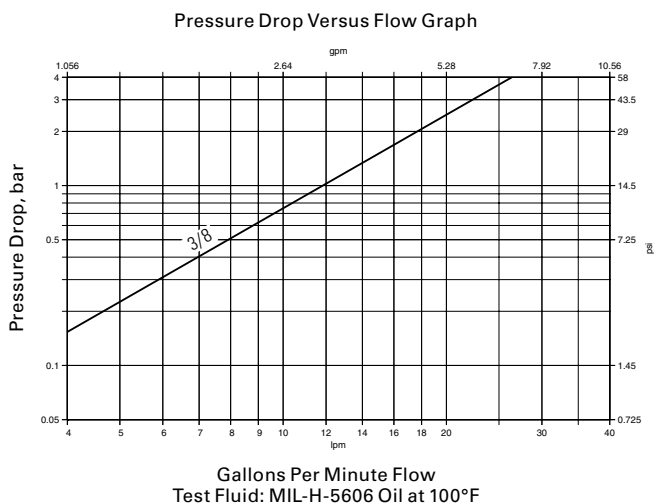

FD35 Series 10,000 psi

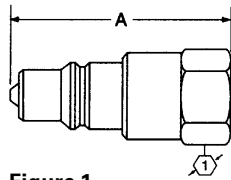

Figure 1

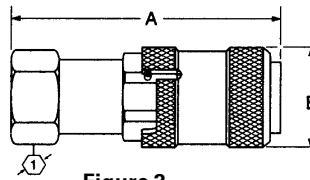

Figure 2

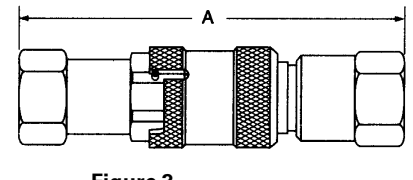

Figure 3

Dimensions (Female NPT, Valved)

Part Number	Coupling Type	Body Size	Port Size	Thread	Type	Fig.	Dimensions A		B		Hex ①	
							mm	(in)	mm	(in)	mm	(in)
FD35-1002-06-06	Plug/Male	3/8"	3/8"	3/8"-18	Female NPT	1	53.8	(2.12)	-	-	23.9	(.94)
FD35-1001-06-06	Socket/Female	3/8"	3/8"	3/8"-18	Female NPT	2	65.0	(2.56)	32.3	(1.27)	23.9	(.94)
FD35-1000-06-06	Complete	3/8"	3/8"	3/8"-18	Female NPT	3	89.9	(3.54)	-	-	-	-

Dimensions (Female SAE O-Ring, Valved)

Part Number	Coupling Type	Body Size	Port Size	Thread	Type	Fig.	Dimensions A		B		Hex ①	
							mm	(in)	mm	(in)	mm	(in)
FD35-1008-06-06	Plug/Male	3/8"	3/16"	3/16"-18	Female SAE O-Ring	1	53.8	(2.12)	-	-	23.9	(.94)
FD35-1007-06-06	Socket/Female	3/8"	3/16"	3/16"-18	Female SAE O-Ring	2	65.0	(2.56)	32.3	(1.27)	23.9	(.94)
FD35-1006-06-06	Complete	3/8"	3/16"	3/16"-18	Female SAE O-Ring	3	89.9	(3.54)	-	-	-	-

Dimensions (Female SAE O-Ring, 125 PSI Bleed Valve)

Part Number	Coupling Type	Body Size	Port Size	Thread	Type	Fig.	Dimensions A		Hex ①	
							mm	(in)	mm	(in)
FD35-1052-06-06	Plug/Male	3/8"	3/16"	3/16"-18	Female SAE O-Ring	1	53.8	(2.12)	23.9	(.94)

Note: Incorporates a special relief valve set at 125 psi, preventing disconnected pressure build-up.

Dust Cap/Plug

Part Number	Body Size
FD35-1042-06	3/8"

Note: Fits male and female halves



Dust Cap/Plug

FLUID TRANSFER
AND HYDRAULIC

PNEUMATIC

SPECIAL APPLICATIONS

DIAGNOSTIC

AGRICULTURE

REFRIGERANT

Safeline Series Operation Guidelines

FLUID TRANSFER
AND HYDRAULIC

PNEUMATIC

SPECIAL APPLICATIONS

DIAGNOSTIC

AGRICULTURE

REFRIGERANT

Elimination of hose whip with two distinct movements:

- 1 Button pressed ▶ Dissipation of downstream pressure:
the plug is retained in the socket
- 2 Plug pushed into the socket ▶ Disconnection

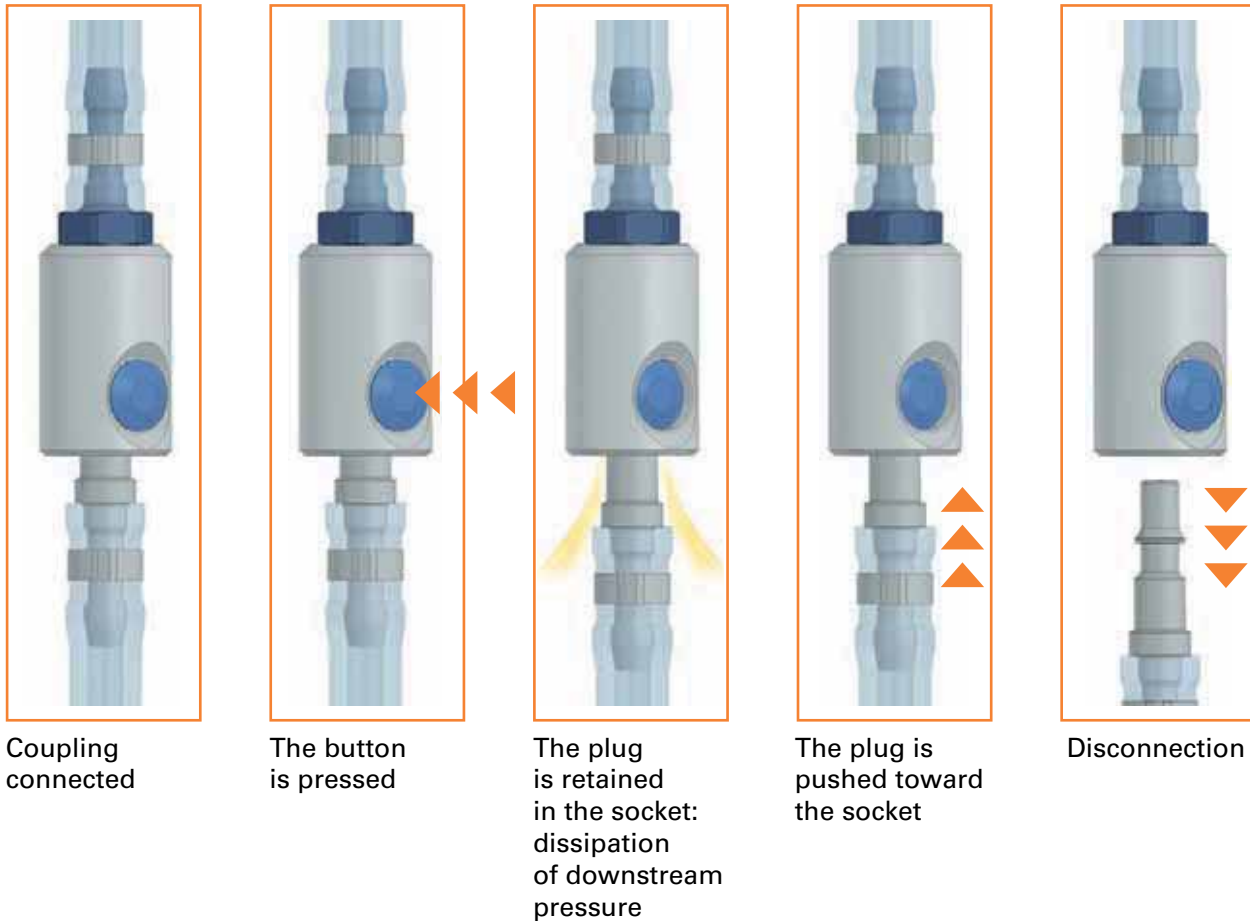

**Recommendation
applicable to all profiles**

Use with vibrating tools:
A flexible hose at least 300 mm long between the tool
and the quick coupling is recommended.

Safeline Series

ISO 6150 B GD10500 Safety-Type Quick-Release



Eaton's Safeline Series is an Industrial Interchange pneumatic coupling with push button safety feature designed for use with compressed air. Two-step disconnect procedure shuts off air supply and releases downstream air pressure before plug can be removed from socket/female, which prevents hose whip.

Product Features

- Safe and easy to connect and disconnect
- Light weight, compact ergonomic design
- Accepts 1/4" ISO 6150 Series B and A-A-59439 plugs/males
- Accepts all US industrial plugs/males
- Standard body material: Aluminum
- Standard seal material: Buna-N

Physical Characteristics

Body Size	Nominal Flow Diameter (mm)	Max. Operating Pressure Connected or Disconnected		Air Flow Rate* Δp 0.6 bar/8.7 psi**		Δp 1 bar/14.5 psi***		Working Temperature	
		(bar)	(psi)	(lpm)	(gpm)	(lpm)	(gpm)	°C	°F
1/4	5.5	16	232	525	139	660	174	-20° +100°	-4° +212°

*Indicated values refer to an inlet pressure of 6 bar / 87 psi.

**This flow rate allows the optimum output from a pneumatic tool.

*** This flow rate is the maximum recommended for a suitable output from a pneumatic tool. For applications needing higher flow rates, it is recommended to select a larger size coupling.

Applications & Markets

- General Pneumatics
- Air Tools
- Industrial Plants
- Maintenance and Repair

Flow Data

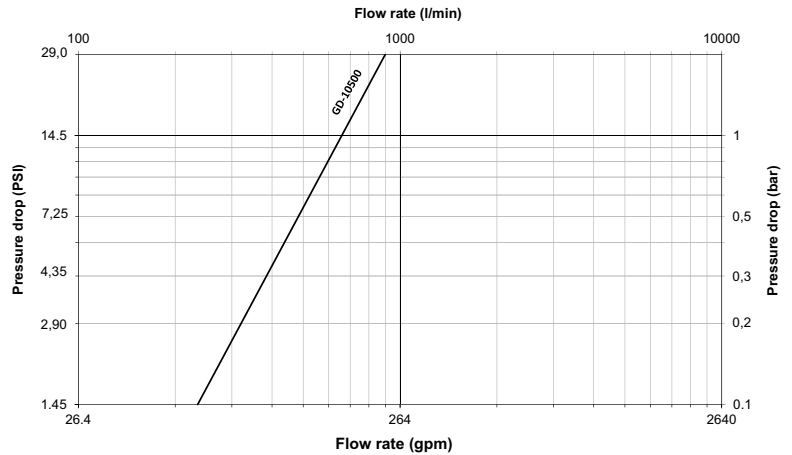

Air flow-rate at 6 bar (87 psi)

Safeline Series

ISO 6150 B GD10500 Safety-Type Quick-Release

FLUID TRANSFER
AND HYDRAULIC

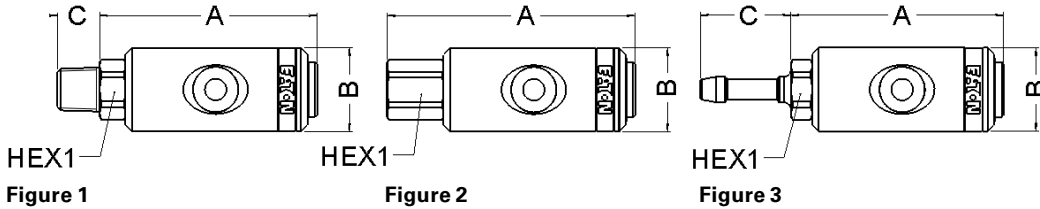

Sockets (Female)

Part Number	Body Size	Port Size	Thread or Hose Diam.	Type	Fig.	Dimensions			Hex1 (in)	Hex2 (in)	A (mm)	B (mm)	C (mm)	Hex1 Weight		
						A (in)	B (in)	C (in)						(mm)	(lbs)	(g)
GD1053615		¼	¼	Male BSPP	1	2.57	1.02	0.47	0.75		65.3	26.0	12.0	19	0.24	110
GD1053614		¼	¼	Male BSPT	1	2.65	1.02	0.51	0.67		67.3	26.0	13.0	17	0.24	109
GD1053641		¼	¼	Male NPT	1	2.65	1.02	0.59	0.67		67.2	26.0	15.1	17	0.24	110
GD1053639		¾	¾	Male BSPP	1	2.61	1.02	0.47	0.87		66.3	26.0	12.0	22	0.27	124
GD1053638		¾	¾	Male BSPT	1	2.65	1.02	0.57	0.67		67.3	26.0	14.5	17	0.26	117
GD1053683		¾	¾	Male NPT	1	2.62	1.02	0.60	0.75		66.5	26.0	15.3	19	0.27	121
GD1053613		½	½	Male BSPP	1	2.69	1.02	0.55	1.06		68.3	26.0	14.0	27	0.33	148
GD1053612		½	½	Male BSPT	1	2.61	1.02	0.67	0.87		66.3	26.0	17.0	22	0.34	156
GD1053621		½	½	Male NPT	1	2.61	1.02	0.79	0.87		66.3	26.0	20.0	22	0.30	137
GD1052614	¼	¼	¼	Female BSPP	2	2.33	1.02	0.00	0.67		76.8	26.0		17	0.24	109
GD1052641		¼	¼	Female NPT	2	2.33	1.02	0.00	0.67		76.3	26.0		17	0.24	109
GD1052638		¾	¾	Female BSPP	2	3.14	1.02	0.00	0.87		79.8	26.0		22	0.29	132
GD1052683		¾	¾	Female NPT	2	3.08	1.02	0.00	0.87		78.3	26.0		22	0.29	132
GD1052612		½	½	Female BSPP	2	3.30	1.02	0.00	1.06		83.8	26.0		27	0.34	155
GD1052621		½	½	Female NPT	2	3.24	1.02	0.00	1.06		82.3	26.0		27	0.35	157
GD1055667		-	6 mm	Reusable Hose Fit.	3	2.59	1.02	1.10	0.67		65.8	26.0	28.0	17	0.23	106
GD1055678		-	7 mm	Reusable Hose Fit.	3	2.57	1.02	1.10	0.67		65.8	26.0	28.0	17	0.24	107
GD1055689		-	8 mm	Reusable Hose Fit.	3	2.33	1.02	1.10	0.67		65.8	26.0	28.0	17	0.24	107
GD1055690		-	9 mm	Reusable Hose Fit.	3	2.33	1.02	1.10	0.67		65.8	26.0	28.0	17	0.24	108
GD1055601		-	10 mm	Reusable Hose Fit.	3	2.33	1.02	1.10	0.67		65.8	26.0	28.0	17	0.25	112

To obtain connected length of coupling add Dimensions A or A+C (Fig. 1, 2, 3) and D or D+E (Fig. 4, 5, 6, 7, 8) together and subtract 23 mm (0,91 in).

*Alternative end connections available upon request.

PNEUMATIC

SPECIAL APPLICATIONS

DIAGNOSTIC

AGRICULTURE

REFRIGERANT

Safeline Series

ISO 6150 B GD10500 Safety-Type Quick-Release

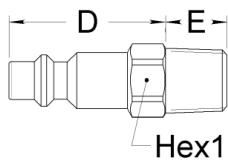

Figure 4

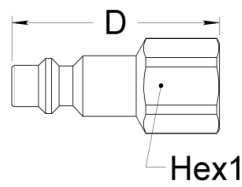

Figure 5

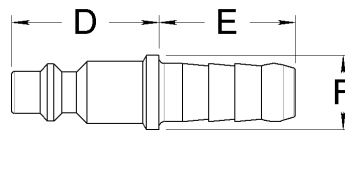

Figure 6

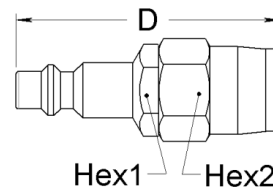

Figure 7

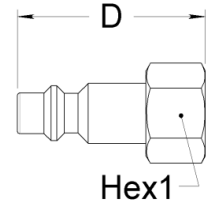

Figure 8

Plugs (Male)

Part Number	Body Size	Port Size	Thread or Hose Diam.	Type	Fig.	Dimensions			Hex1 (in)	Hex2 (in)	D (mm)	E (mm)	F (mm)	Hex1 (mm)	Hex2 (mm)	Weight	
						D (in)	E (in)	F (in)								(lbs)	(g)
GA0066318		1/8	1/8-28	Male BSPT	4	1.260	0.354	0.472			32	9		12		0.04189	19
GA0066314		1/4	1/4-19	Male BSPT	4	1.260	0.512	0.551			32	13		14		0.06	25
10		1/4	1/4-18	Male NPT	4	1.220	0.551	0.591			31	14		15		0.06	25
GA0066338		3/8	3/8-19	Male BSPT	4	1.260	0.591	0.669			32	15		17		0.08	38
GA0066345		M14	M14x125	Male Metric	4	1.260	0.512	0.551			32	13		14		0.06	26
GA0066214		1/4	1/4-19	Female BSPP	5	1.732		0.669			44			17		0.07	30
11		1/4	1/4-18	Female NPT	5	1.634		0.709			41.5			18		0.07	30
GA0066238		3/8	3/8-19	Female BSPP	5	1.732		0.827			44			21		0.08	37
GA0066245		M14	M14x125	Female Metric	5	1.732		0.669			44			17		0.06	25
GA0066248	1/4	-	M14x125	Female Metric	5	1.732		0.551			44			14		0.05	24
GA0066767		-	6mm	Hose Tail	6	1.102	1.024	0.551			28	26	14			0.04	19
GA0066778		-	7mm	Hose Tail	6	1.102	1.024	0.551			28	26	14			0.04	20
GA0066789		-	8mm	Hose Tail	6	1.102	1.024	0.551			28	26	14			0.04	20
GA0066790		-	9mm	Hose Tail	6	1.102	1.024	0.551			28	26	14			0.04	20
GA0066701		-	10mm	Hose Tail	6	1.102	1.024	0.551			28	26	14			0.05	22
GA0066174		-	7x14 mm	Reusable Hose Fit.	7	2.224		0.630	0.748	56.5				16	19	0.12	56
GA0066184		-	8x14 mm	Reusable Hose Fit.	7	2.224		0.630	0.748	56.5				16	19	0.13	57
GA0066185		-	8x15 mm	Reusable Hose Fit.	7	2.224		0.630	0.748	56.5				16	19	0.12	53
GA0066196		-	9x16 mm	Reusable Hose Fit.	7	2.224		0.630	0.748	56.5				16	19	0.11	51
GA0066814		1/4	1/4-19	Female BSPP Swivel	8	1.496		0.669		38				17		0.06	26
GA0066845		M14	M14x125	Female Metric Swivel	8	1.496		0.669		38				17		0.06	26

To obtain connected length of coupling add Dimensions A or A+C (Fig. 1, 2, 3) and D or D+E (Fig. 4, 5, 6, 7, 8) together and subtract 23 mm (0,91 in).

*Alternative end connections available upon request.

FLUID TRANSFER AND HYDRAULIC

PNEUMATIC

SPECIAL APPLICATIONS

DIAGNOSTIC

AGRICULTURE

REFRIGERANT

Safeline Series

ISO 6150 B ID10900 Safety-Type Quick-Release



Eaton Gromelle™ ID10900 Series is a single shut-off compressed air coupling that incherchanges with ISO 6150 C Standards requirements. Nominal diameter is 8 mm. Thanks to a distinct two-movement action, our couplings guarantee worker safety at disconnection by eliminating the “whiplash” effect. It is a must-have for safe air applications.

Product Features

- One-hand push-to-connect
- Automatic button for disconnection
- Meets safety standard ISO 4414
- Single shut-off valving
- Good flow capacity
- Wide selection of end connections
- Standard seal material: NBR (Nitrile)
- Standard body material (Female): Aluminum
- Standard body material (Male): Zinc plated steel

Physical Characteristics

Body Size	Nominal Flow Diameter (mm)	Max. Operating Pressure Connected or Disconnected		Air Flow Rate* Δp 0.6 bar/8.7 psi**			Working Temperature		
		(bar)	(psi)	(lpm)	(gpm)	(lpm)	(gpm)	°C	°F
8	8	16	232	1,590	420	2,000	528	-20° +100°	-4° +212°

*Indicated values refer to an inlet pressure of 6 bar / 87 psi.

**This flow rate allows the optimum output from a pneumatic tool.

**This flow rate is the maximum recommended for a suitable output from a pneumatic tool. For applications needing higher flow rates, it is recommended to select a larger size coupling.

Applications & Markets

- General Pneumatics
- Air Tools

Flow Data

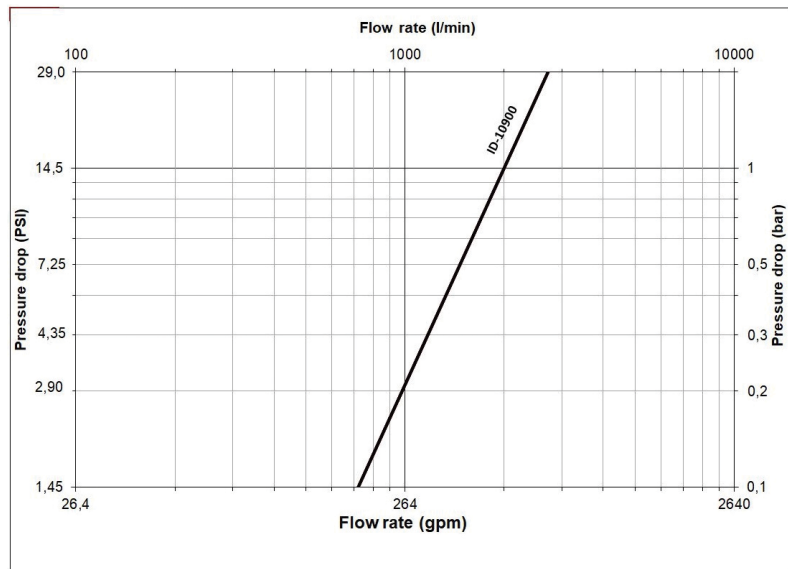

Air Flow-rate at 6 bar (87psi)

Safeline Series

ISO 6150 B ID10900 Safety-Type Quick-Release

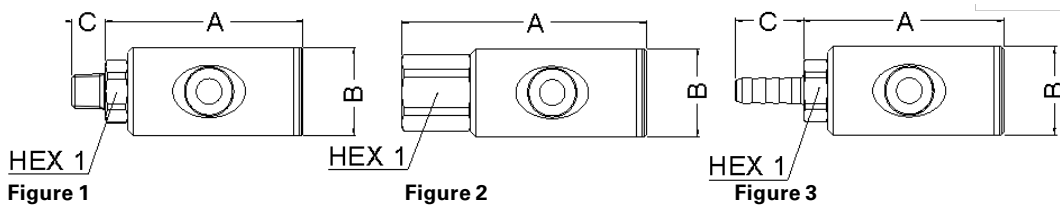

Sockets (Female)

Part Number	Body Size	Port Size	Thread or Hose Diam.	Type	Fig.	Dimensions			Hex1 (in)	A (mm)	B (mm)	C (mm)	Hex1 (mm)	Weight	
						A (in)	B (in)	C (in)						(lbs)	(g)
ID1096015		¼	¼	Male BSPP	1	3.0	1.3	0.5	0.87	76.2	34	11.9	22	0.47	214
ID1096014		¼	¼	Male BSPT	1	3.0	1.3	0.5	0.87	76.1	34	13	22	0.47	213
ID1096041		¼	¼	Male NPT	1	3.0	1.3	0.5	0.87	76	34	13	22	0.47	213
ID1096039		¾	¾	Male BSPP	1	3.0	1.3	0.5	0.87	76.20	34	11.9	22	0.48	218
ID1096038		¾	¾	Male BSPT	1	3.0	1.3	0.6	0.87	76.1	34	15	22	0.48	219
ID1096083		¾	¾	Male NPT	1	3.0	1.3	0.6	0.87	76.1	34	15	22	0.48	219
ID1096013		½	½	Male BSPP	1	3.0	1.3	0.5	1.06	76.2	34	13.9	27	0.52	238
ID1096012		½	½	Male BSPT	1	3.0	1.3	0.7	0.87	76.1	34	17	22	0.51	233
ID1096021		½	½	Male NPT	1	3.0	1.3	0.7	0.87	76.1	34	17	22	0.51	233
ID1097014	¾	¼	¼	Female BSPP	2	3.5	1.3	-	0.87	88.1	34	-	22	0.51	233
ID1097041	¾	¼	¼	Female NPT	2	3.5	1.3	-	0.87	88.10	34	-	22	0.51	233
ID1097038	¾	¾	¾	Female BSPP	2	3.6	1.3	-	0.87	90.60	34	-	22	0.51	232
ID1097083	¾	¾	¾	Female NPT	2	3.6	1.3	-	0.87	90.6	34	-	22	0.51	232
ID1097012	¾	½	½	Female BSPP	2	3.7	1.3	-	1.06	94.1	34	-	27	0.59	267
ID1097021	¾	½	½	Female NPT	2	3.7	1.3	-	1.06	94.1	34	-	27	0.59	269
ID1095678	-	-	7 mm	Hose Tail	3	3.0	1.3	1.1	0.87	77.1	34	28	22	0.47	215
ID1095689	-	-	8 mm	Hose Tail	3	3.0	1.3	1.1	0.87	77.1	34	28	22	0.48	216
ID1095690	-	-	9 mm	Hose Tail	3	3.0	1.3	1.1	0.87	77.1	34	28	22	0.48	218
ID1095601	-	-	10 mm	Hose Tail	3	3.0	1.3	1.1	0.87	77.1	34	28	22	0.48	219

To obtain connected length of coupling add dimensions A or A+C (Fig. 1, 2, 3) and D or D+E (Fig. 4, 5, 6) together and subtract 25,6 mm (1 in.).

*Alternative end connections available upon request.

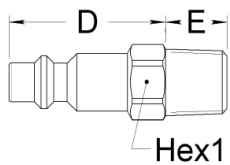

Figure 4

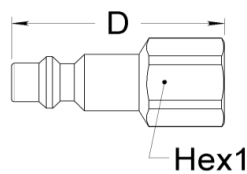

Figure 5



Figure 6

Plugs (Male)

Part Number	Body Size	Port Size	Thread or Hose Diam.	Type	Fig.	Dimensions			Hex1 (in)	D (mm)	E (mm)	F (mm)	Hex1 (mm)	Weight	
						D (in)	E (in)	F (in)						(lbs)	(g)
IA0090614		¼	¼	Male BSPT	4	1.34	0.51	-	0.63	34.00	13.00	-	16.00	0.07	32.00
IA0090638		¾	¾	Male BSPT	4	1.42	0.59	-	0.67	36.00	15.00	-	17.00	0.09	41.00
IA0090612		½	½	Male BSPT	4	1.57	0.67	-	0.91	40.00	17.00	-	23.00	0.12	56.00
IA0090714		¼	¼	Female BSPP	5	1.97	-	-	0.67	50.00	-	-	17.00	0.08	38.00
IA0090738		¾	¾	Female BSPP	5	1.97	-	-	0.83	50.00	-	-	21.00	0.11	49.00
IA0090712	¾	½	½	Female BSPP	5	2.09	-	-	1.02	53.00	-	-	26.00	0.15	69.00
IA0090978	-	-	7 mm	Hose Tail	6	1.30	1.02	0.63	-	33.00	26.00	16.00	-	0.07	30.00
IA0090989	-	-	8 mm	Hose Tail	6	1.30	1.02	0.63	-	33.00	26.00	16.00	-	0.07	30.00
IA0090990	-	-	9 mm	Hose Tail	6	1.30	1.02	0.63	-	33.00	26.00	16.00	-	0.07	31.00
IA0090901	-	-	10 mm	Hose Tail	6	1.30	1.02	0.63	-	33.00	26.00	16.00	-	0.07	32.00
IA0090912	-	-	11-12 mm	Hose Tail	6	1.30	1.22	0.63	-	33.00	31.00	16.00	-	0.08	38.00

To obtain connected length of coupling add dimensions A or A+C (Fig. 1, 2, 3) and D or D+E (Fig. 4, 5, 6) together and subtract 25,6 mm (1 in.).

*Alternative end connections available upon request.

FLUID TRANSFER
AND HYDRAULIC

PNEUMATIC

SPECIAL APPLICATIONS

DIAGNOSTIC

AGRICULTURE

REFRIGERANT

Safeline Series

ISO 6150 C GD18500/GK18600

FLUID TRANSFER
AND HYDRAULIC

PNEUMATIC

SPECIAL APPLICATIONS

DIAGNOSTIC

AGRICULTURE

REFRIGERANT



Eaton's Safeline Series is an Industrial Interchange pneumatic coupling with push button safety feature designed for use with compressed air. Two-step disconnect procedure shuts off air supply and releases downstream air pressure before plug can be removed from socket/female, which prevents hose whip.

Product Features

- Safe and easy to connect and disconnect
- Light weight, compact ergonomic design
- Meets Safety Standard ISO 4414
- Meets ISO 6150 Series C Standard
- Standard body material: Dural
- Standard seal material: Buna-N

Physical Characteristics

Body Size	Nominal Flow Diameter (mm)	Max. Operating Pressure Connected or Disconnected		Air Flow Rate* Δp 0.6 bar/8.7 psi**				Working Temperature	
		(bar)	(psi)	(lpm)	(gpm)	(lpm)	(gpm)	°C	°F
1/4	5.5	16	232	515	136	650	172	-20° +100°	-4° +212°

*Indicated values refer to an inlet pressure of 6 bar / 87 psi.
 **This flow rate allows the optimum output from a pneumatic tool.
 *** This flow rate is the maximum recommended for a suitable output from a pneumatic tool. For applications needing higher flow rates, it is recommended to select a larger size coupling.

Applications & Markets

- General Pneumatics
- Air Tools
- Industrial Plants
- Maintenance and Repair

Flow Data

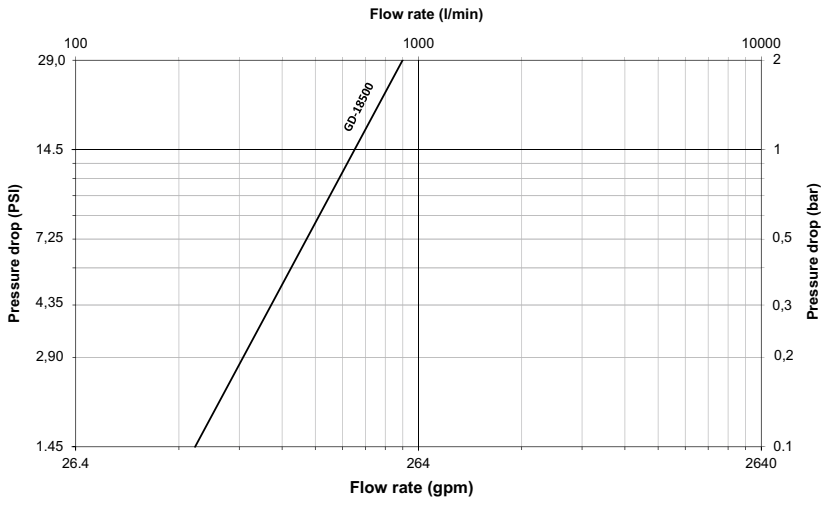

Air flow-rate at 6 bar (87 psi)

Safeline Series

ISO 6150 C GD18500/GK18600

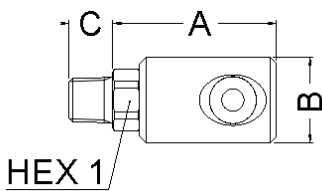

Figure 1

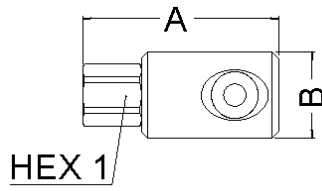

Figure 2

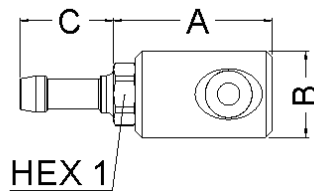

Figure 3

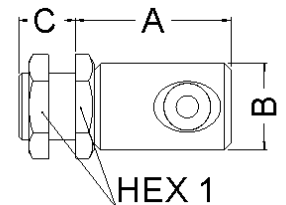

Figure 4

Sockets (Female)

Part Number	Body Size	Port Size	Thread or Hose Diam.	Type	Fig.	Dimensions			Hex1 (in)	A (mm)	B (mm)	C (mm)	Hex1 (mm)	Weight	
						A (in)	B (in)	C (in)						(lbs)	(g)
GD1853615		¼	¼	Male BSPP	1	1.85	1.02	0.47	0.75	47	26	12	19	0.17	77
GD1853614		¼	¼	Male BSPT	1	1.93	1.02	0.51	0.67	49	26	13	17	0.17	76
GD1853639		⅜	⅜	Male BSPP	1	1.89	1.02	0.47	0.87	48	26	12	22	0.20	91
GD1853638		⅜	⅜	Male BSPT	1	1.93	1.02	0.57	0.67	49	26	14.5	17	0.19	84
GD1853613		½	½	Male BSPP	1	1.97	1.02	0.55	1.06	50	26	14	27	0.25	115
GD1853612		½	½	Male BSPT	1	1.89	1.02	0.67	0.87	48	26	17	22	0.27	123
GD1852614		¼	¼	Female BSPP	2	2.30	1.02		0.67	58.5	26	-	17	0.17	76
GD1852638	¼	⅜	⅜	Female BSPP	2	2.42	1.02		0.87	61.5	26	-	22	0.22	99
GD1852612		½	½	Female BSPP	2	2.58	1.02		1.06	65.5	26	-	27	0.27	122
GD1855667		-	6 mm	Hose Tail	3	1.87	1.02	1.10	0.67	47.5	26	28	17	0.16	73
GD1855678		-	7 mm	Hose Tail	3	1.87	1.02	1.10	0.67	47.5	26	28	17	0.16	74
GD1855689		-	8 mm	Hose Tail	3	1.87	1.02	1.10	0.67	47.5	26	28	17	0.16	74
GD1855690		-	9 mm	Hose Tail	3	1.87	1.02	1.10	0.67	47.5	26	28	17	0.17	75
GD1855601		-	10 mm	Hose Tail	3	1.87	1.02	1.10	0.67	47.5	26	28	17	0.17	79
GD1855613		-	13 mm	Hose Tail	3	1.87	1.02	1.30	0.67	47.5	26	33	17	0.19	87
GD1855014		¼	¼	Female BSPP, Bulkhead*	4	1.83	1.02	0.67	1.06	46.5	26	17	27	0.25	112
GD1855038		⅜	⅜	Female BSPP, Bulkhead**	4	1.87	1.02	0.79	1.26	47.5	26	20	32	0.33	150

To obtain connected length of coupling add Dimensions A or A+C (Fig. 1, 2, 3, 4) and D or D+E (Fig. 5, 6, 7) together and subtract 26 mm (1,02 in).

*Max bulkhead thickness: 10 mm (0,39 in) / Bulkhead hole diameter = 21 mm (0,83 in).

**Max bulkhead thickness: 12 mm (0,47 in) / Bulkhead hole diameter = 25 mm (0,98 in).

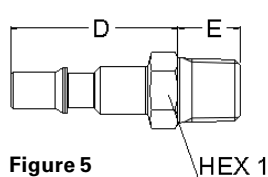

Figure 5

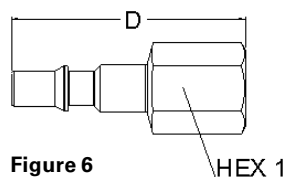

Figure 6

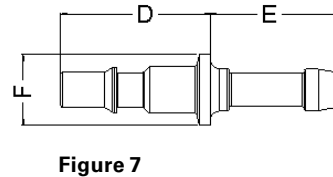

Figure 7

Plugs (Male)

Part Number	Body Size	Port Size	Thread or Hose Diam.	Type	Fig.	Dimensions			Hex1 (in)	Hex2 (in)	D (mm)	E (mm)	F (mm)	Hex1 (mm)	Hex2 (mm)	Weight	
						D (in)	E (in)	F (in)								(lbs)	(g)
GK1866319		⅜	⅜	Male BSPP	5	1.38	0.31	0.55			35	8		14		0.04	17
GK1866318		⅜	⅜	Male BSPT	5	1.34	0.31	0.47			34	8		12		0.03	14
GK1866381		⅜	⅜	Male NPT	5	1.34	0.39	0.47			34	10		12		0.03	15
GK1866315		¼	¼	Male BSPP	5	1.42	0.47	0.67			36	12		17		0.06	25
GK1866314		¼	¼	Male BSPT	5	1.40	0.51	0.55			35.5	13		14		0.05	23
GK1866341		¼	¼	Male NPT	5	1.42	0.59	0.67			36	15		17		0.07	30
GK1866339		⅜	⅜	Male BSPP	5	1.46	0.47	0.87			37	12		22		0.09	39
GK1866338		⅜	⅜	Male BSPT	5	1.48	0.47	0.75			37.5	12		19		0.08	37
GK1866218		⅜	⅜	Female BSPP	6	1.63		0.55			41.5			14		0.04	18
GK1866281	¼	⅜	⅜	Female NPT	6	0.00		0.00								0.04	18
GK1866214		¼	¼	Female BSPP	6	1.97		0.67			50			17		0.07	33
GK1866241		¼	¼	Female NPT	6	1.97		0.67			50			17		0.07	32
GK1866238		⅜	⅜	Female BSPP	6	1.85		0.83			47			21		0.08	35
GK1866245		M 14	M 14 x 125	Female Metric	6	1.87		0.67			47.5			17		0.06	26
GK1866767		-	6 mm	Hose Tail	7	1.26	1.10	0.59			32	28	15			0.03	15
GK1866778		-	7 mm	Hose Tail	7	1.26	1.10	0.59			32	28	15			0.04	18
GK1866789		-	8 mm	Hose Tail	7	1.26	1.10	0.59			32	28	15			0.04	19
GK1866790		-	9 mm	Hose Tail	7	1.26	1.10	0.59			32	28	15			0.04	19
GK1866701		-	10 mm	Hose Tail	7	1.26	1.10	0.59			32	28	15			0.04	20
GK1866713		-	13 mm	Hose Tail	7	1.26	1.30	0.79			32	33	20			0.08	34

To obtain connected length of coupling add Dimensions A or A+C (Fig. 1, 2, 3, 4) and D or D+E (Fig. 5, 6, 7) together and subtract 26 mm (1,02 in).

FLUID TRANSFER AND HYDRAULIC

PNEUMATIC

SPECIAL APPLICATIONS

DIAGNOSTIC

AGRICULTURE

REFRIGERANT

Safeline Series

ISO 6150 C ID18900/IK18900

FLUID TRANSFER
AND HYDRAULIC

PNEUMATIC

SPECIAL APPLICATIONS

DIAGNOSTIC

AGRICULTURE

REFRIGERANT



Eaton's Safeline Series is an Industrial Interchange pneumatic coupling with push button safety feature designed for use with compressed air. Two-step disconnect procedure shuts off air supply and releases downstream air pressure before plug can be removed from socket/female, which prevents hose whip.

Product Features

- Safe and easy to connect and disconnect
- Light weight, compact ergonomic design
- Meets Safety Standard ISO 4414
- Meets ISO 6150 Series C Standard
- Standard body material: Dural
- Standard seal material: Buna-N

Physical Characteristics

Body Size	Nominal Flow Diameter (mm)	Max. Operating Pressure Connected or Disconnected		Air Flow Rate* Δp 0.6 bar/8.7 psi**				Working Temperature	
		(bar)	(psi)	(lpm)	(gpm)	(lpm)	(gpm)	°C	°F
3/8"	8	16	232	1,080	285	1,350	356	-20° +100°	-4° +212°

*Indicated values refer to an inlet pressure of 6 bar / 87 psi.

**This flow rate allows the optimum output from a pneumatic tool.

*** This flow rate is the maximum recommended for a suitable output from a pneumatic tool. For applications needing higher flow rates, it is recommended to select a larger size coupling.

Applications & Markets

- General Pneumatics
- Air Tools
- Industrial Plants
- Maintenance and Repair

Flow Data

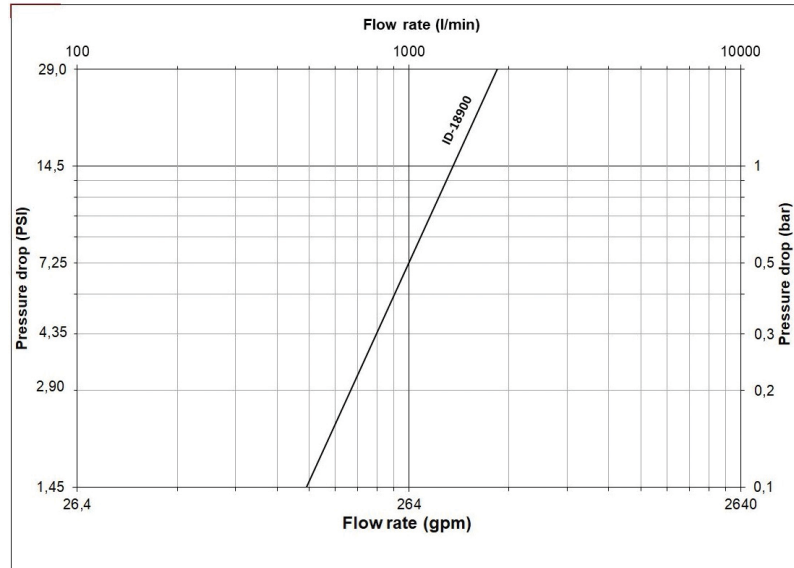

Air flow-rate at 6 bar (87 psi)

Safeline Series

ISO 6150 CID18900/IK18900

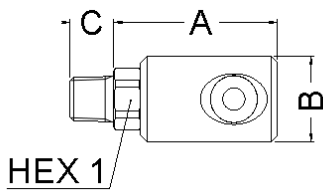

Figure 1

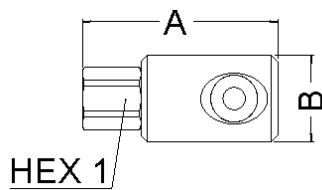

Figure 2

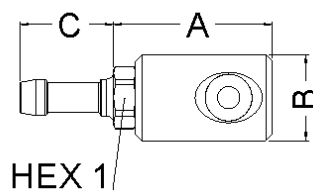

Figure 3

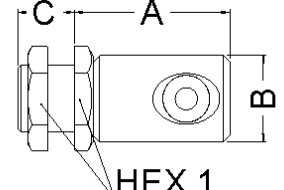

Figure 4

Sockets (Female)

Part Number	Body Size	Port Size	Thread or Hose Diam.	Type	Fig.	Dimensions									
						A	B	C	Hex1	A	B	C	Hex1	Weight	
						(in)	(in)	(in)	(in)	(mm)	(mm)	(mm)	(mm)	(lbs)	(g)
ID1896015		¼	¼	Male BSPP	1	2.45	1.34	0.47	0.87	62	34	12	22	0.35	160
ID1896014		¼	¼	Male BSPT	1	2.45	1.34	0.51	0.87	62	34	13	22	0.36	162
ID1896039		⅜	⅜	Male BSPP	1	2.45	1.34	0.47	0.87	62	34	12	22	0.36	165
ID1896038		⅜	⅜	Male BSPT	1	2.45	1.34	0.59	0.87	62	34	15	22	0.37	168
ID1896013		½	½	Male BSPP	1	2.45	1.34	0.55	1.06	62	34	14	27	0.37	168
ID1896012		½	½	Male BSPT	1	2.45	1.34	0.67	0.87	62	34	17	22	0.40	180
ID1897014		¼	¼	Female BSPP	2	2.92	1.34	-	0.87	74	34	-	22	0.40	182
ID1897038	¾	¾	¾	Female BSPP	2	3.02	1.34	-	0.87	77	34	-	22	0.40	180
ID1897012		½	½	Female BSPP	2	3.16	1.34	-	1.06	80	34	-	27	0.48	216
ID1895689		-	8 mm	Hose Tail	3	2.49	1.34	1.10	0.87	63	34	28	22	0.36	165
ID1895690		-	9 mm	Hose Tail	3	2.49	1.34	1.10	0.87	63	34	28	22	0.35	160
ID1895601		-	10 mm	Hose Tail	3	2.49	1.34	1.10	0.87	63	34	28	22	0.37	166
ID1895613		-	13 mm	Hose Tail	3	2.49	1.34	1.30	0.87	63	34	33	22	0.39	177
ID1895038		¾	¾	Female BSPP, Bulkhead*	4	2.37	1.34	0.79	1.26	60	34	20	32	0.52	235
ID1895012		½	¾	Female BSPP, Bulkhead**	4	2.39	1.34	0.91	1.38	61	34	23	35	0.59	269

To obtain connected length of coupling add Dimensions A or A+C (Fig. 1, 2, 3, 4) and D or D+E (Fig. 5, 6, 7) together and subtract 40 mm (1,57 in).

*Max bulkhead thickness: 12 mm (0,47 in) / Bulkhead hole diameter = 25 mm (0,98 in)

**Max bulkhead thickness: 15 mm (0,59 in) / Bulkhead hole diameter = 31 mm (1,22 in)

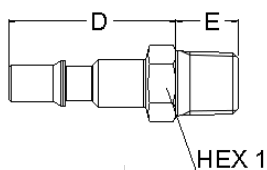

Figure 5

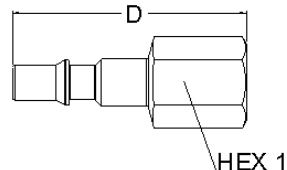

Figure 6

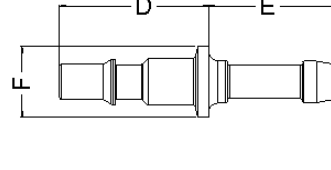

Figure 7

Plugs (Male)

Part Number	Body Size	Port Size	Thread or Hose Diam.	Type	Fig.	Dimensions									
						D	E	F	Hex1	D	E	F	Hex1	Weight	
						(in)	(in)	(in)	(in)	(mm)	(mm)	(mm)	(mm)	(lbs)	(g)
IK1890615		¼	¼	Male BSPP	5	1.81	0.47	-	0.75	46	12	-	19	0.10	44
IK1890614		¼	¼	Male BSPT	5	1.77	0.51	-	0.67	45	13	-	17	0.08	38
IK1890641		¼	¼	Male NPT	5	1.77	0.51	-	0.67	45	13	-	17	0.09	39
IK1890639		⅜	⅜	Male BSPP	5	1.81	0.47	-	0.87	46	12	-	22	0.11	51
IK1890638		⅜	⅜	Male BSPT	5	1.77	0.59	-	0.75	45	15	-	19	0.11	51
IK1890683		⅜	⅜	Male NPT	5	1.77	0.59	-	0.75	45	15	-	19	0.11	52
IK1890613		½	½	Male BSPP	5	1.81	0.55	-	1.02	46	14	-	26	0.16	73
IK1890612	¾	½	½	Male BSPT	5	1.77	0.67	-	0.87	45	17	-	22	0.15	66
IK1890714		¼	¼	Female BSPP	6	2.36	-	-	0.67	60	-	-	17	0.09	40
IK1890741		¼	¼	Female NPT	6	2.36	-	-	0.67	60	-	-	17	0.09	40
IK1890738		⅜	⅜	Female BSPP	6	2.36	-	-	0.83	60	-	-	21	0.11	52
IK1890783		⅜	⅜	Female NPT	6	2.36	-	-	0.83	60	-	-	21	0.12	55
IK1890712		½	½	Female BSPP	6	2.36	-	-	1.02	60	-	-	26	0.15	66
IK1890989		-	8 mm	Hose Tail	7	1.65	1.10	0.63	-	42	28	16	-	0.07	33
IK1890990		-	9 mm	Hose Tail	7	1.65	1.10	0.63	-	42	28	16	-	0.07	33
IK1890901		-	10 mm	Hose Tail	7	1.65	1.10	0.63	-	42	28	16	-	0.08	35
IK1890913		-	13 mm	Hose Tail	7	1.65	1.30	0.79	-	42	33	20	-	0.10	46

To obtain connected length of coupling add Dimensions A or A+C (Fig. 1, 2, 3, 4) and D or D+E (Fig. 5, 6, 7) together and subtract 40 mm (1,57 in).

FLUID TRANSFER
AND HYDRAULIC

PNEUMATIC

SPECIAL APPLICATIONS

DIAGNOSTIC

AGRICULTURE

REFRIGERANT

Safeline Series

ISO 6150 CTD18300/TK18300

FLUID TRANSFER
AND HYDRAULIC

PNEUMATIC

SPECIAL APPLICATIONS

DIAGNOSTIC

AGRICULTURE

REFRIGERANT



Eaton's Safeline Series is an Industrial Interchange pneumatic coupling with push button safety feature designed for use with compressed air. Two-step disconnect procedure shuts off air supply and releases downstream air pressure before plug can be removed from socket/female, which prevents hose whip.

Product Features

- Safe and easy to connect and disconnect
- Light weight, compact ergonomic design
- Meets Safety Standard ISO 4414
- Meets ISO 6150 Series C Standard
- Standard body material: Dural
- Standard seal material: Buna-N

Physical Characteristics

Body Size	Nominal Flow Diameter (mm)	Max. Operating Pressure Connected or Disconnected		Air Flow Rate* Δp 0.6 bar/8.7 psi**		Δp 1 bar/14.5 psi***		Working Temperature	
		(bar)	(psi)	(lpm)	(gpm)	(lpm)	(gpm)	°C	°F
1/2	11	16	232	2,400	634	3,000	793	-20° +100°	-4° +212°

*Indicated values refer to an inlet pressure of 6 bar / 87 psi.

**This flow rate allows the optimum output from a pneumatic tool.

*** This flow rate is the maximum recommended for a suitable output from a pneumatic tool. For applications needing higher flow rates, it is recommended to select a larger size coupling.

Applications & Markets

- General Pneumatics
- Air Tools
- Industrial Plants
- Maintenance and Repair

Flow Data

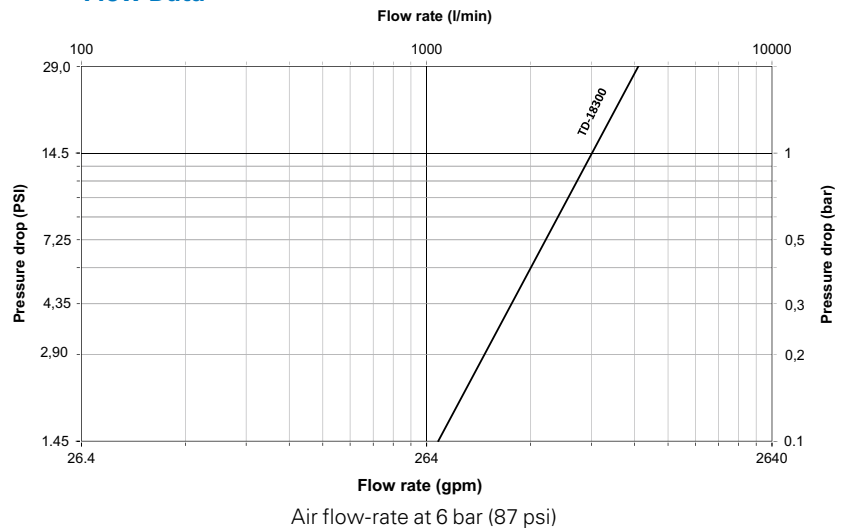

Safeline Series

ISO 6150 C TD18300/TK18300

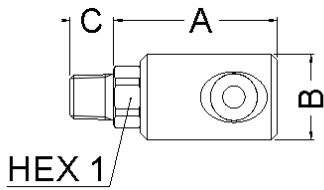

Figure 1

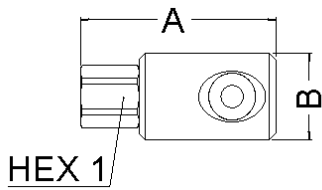

Figure 2

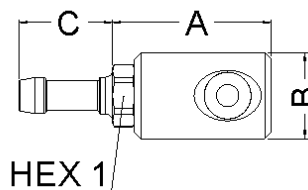

Figure 3

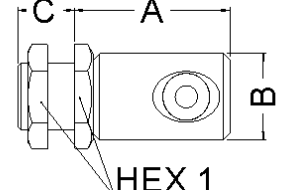

Figure 4

Sockets (Female)

Part Number	Body Size	Port Size	Thread or Hose Diam. Type	Fig.	Dimensions											
					A	B	C	Hex1	Hex2	A	B	C	Hex1	Hex2	Weight	
					(in)	(in)	(in)	(in)	(in)	(mm)	(mm)	(mm)	(mm)	(mm)	(lbs)	(g)
TD1832012		½	½	Male BSPT	1	2.78	1.56	0.67	1.06		70.6	39.5	17	27	0.58	262
TD1832034		¾	¾	Male BSPT	1	2.78	1.56	0.73	1.14		70.6	39.5	19	29	0.63	287
TD1832138		¾	¾	Female BSPP	2	3.27	1.56		1.06		83.1	39.5	-	27	0.62	280
TD1832112		½	½	Female BSPP	2	3.27	1.56		1.06		83.1	39.5	-	27	0.58	261
TD1832134	½	¾	¾	Female BSPP	2	3.51	1.56		1.26		89.1	39.5	-	32	0.67	304
TD1835601	-		10 mm	Hose Tail	3	2.84	1.56	1.10	1.06		72.1	39.5	28	27	0.56	256
TD1835613	-		13 mm	Hose Tail	3	2.84	1.56	1.30	1.06		72.1	39.5	33	27	0.59	267
TD1835616	-		16 mm	Hose Tail	3	2.84	1.56	1.30	1.06		72.1	39.5	33	27	0.60	270
TD1835012		½	½	Female BSPP, Bulkhead*	4	2.78	1.56	0.91	1.38		70.6	39.5	23	35	0.76	343
TD1835034		¾	¾	Female BSPP, Bulkhead**	4	2.82	1.56	0.98	1.50		71.6	39.5	25	38	0.77	350

To obtain connected length of coupling add Dimensions A or A+C (Fig. 1, 2, 3, 4) and D or D+E (Fig. 5, 6, 7) together and subtract 20 mm (0,79 in).

*Max bulkhead thickness: 15 mm (0,59 in) / Bulkhead hole diameter = 31 mm (1,22 in)

**Max bulkhead thickness: 16 mm (0,63 in) / Bulkhead hole diameter = 33 mm (1,30 in)

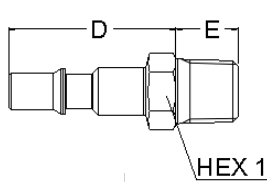

Figure 5

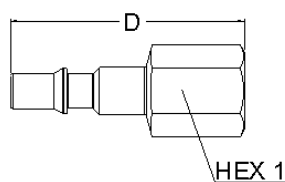

Figure 6

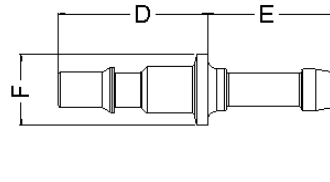

Figure 7

Plugs (Male)

Part Number	Body Size	Port Size	Thread or Hose Diam. Type	Fig.	Dimensions											
					D	E	F	Hex1	D	E	F	Hex1	Weight			
					(in)	(in)	(in)	(in)	(mm)	(mm)	(mm)	(mm)	(mm)	(lbs)	(g)	
TK1831539		¾	¾	Male BSPP	5	2.01	0.47		0.87		51.1	11.9		22	2.32	59
TK1831512		½	½	Male BSPT	5	1.97	0.67		0.87		50	17		22	2.56	65
TK1831534		¾	¾	Male BSPT	5	2.11	0.73		1.14		53.5	18.5		29	3.86	98
TK1831638		¾	¾	Female BSPP	6	2.56			1.02		65			26	3.70	94
TK1831612	½	½	½	Female BSPP	6	2.56			1.02		65			26	3.02	77
TK1831634		¾	¾	Female BSPP	6	2.87			1.26		73			32	5.02	128
TK1831889	-		8 mm	Hose Tail	7	1.85	1.10	0.79			47	28	20		1.87	48
TK1831801	-		10 mm	Hose Tail	7	1.85	1.10	0.79			47	28	20		1.91	48
TK1831813	-		13 mm	Hose Tail	7	1.85	1.30	0.79			47	33	20		2.19	56
TK1831816	-		16 mm	Hose Tail	7	1.85	1.30	0.79			47	33	20		2.40	61

To obtain connected length of coupling add Dimensions A or A+C (Fig. 1, 2, 3, 4) and D or D+E (Fig. 5, 6, 7) together and subtract 20 mm (0,79 in).

FLUID TRANSFER AND HYDRAULIC

PNEUMATIC

SPECIAL APPLICATIONS

DIAGNOSTIC

AGRICULTURE

REFRIGERANT

1000 Series



Eaton's 1000 Series is an Industrial Interchange pneumatic coupling that is rugged and reliable designed for use with compressed air, gases and liquids.

Product Features

- Ball-latching mechanism
- Optional sleeve lock prevents accidental disconnection
- All sizes accept U.S. Industrial Interchange
- 1/4" accepts ISO 6150 B and A-A-59439 plugs/males
- Standard body material: Brass with nickel plated steel sleeve
- Standard seal material: Buna-N
- Optional seal materials: Silicone-138, FKM-143, EPDM-192

Physical Characteristics

Series	Body Size	Max. Operating Pressure		Min. Burst Pressure		Rated Flow	
	(in)	(bar)	(psi)	(bar)	(psi)	(lpm)	(gpm)
1000	1/4	138	2,000	552	8,000	679	179

Applications & Markets

- General Pneumatics
- Construction
- Industrial Plants

Flow Data

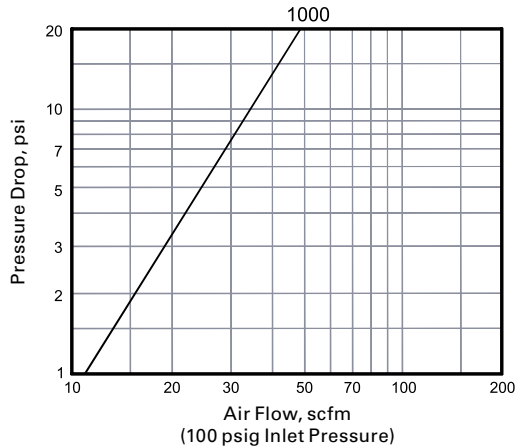

FLUID TRANSFER
AND HYDRAULIC

PNEUMATIC

SPECIAL APPLICATIONS

DIAGNOSTIC

AGRICULTURE

REFRIGERANT

1000 Series

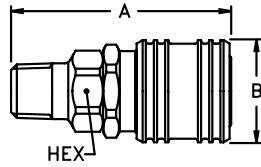

Figure 1

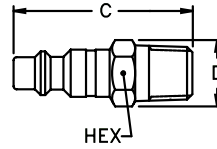

Figure 2

Male NPTF Connections

Part Number	Coupling Type	Body Size	Port Size	Thread	Type	Material	Fig.	Dimensions					
								A (in)	B (in)	Hex (in)	A (mm)	B (mm)	Hex (mm)
900	Socket/Female	¼	¼	¼-27	NPTF	Brass	1	1.97	1.00	0.69	50.04	25.40	17.53
1100	Socket/Female	¼	¼	¼-18	NPTF	Brass	1	2.16	1.00	0.69	54.86	25.40	17.53
1300	Socket/Female	¼	¾	¾-18	NPTF	Brass	1	2.12	1.00	0.69	53.85	25.40	17.53
LL1100	Socket/Female	¼	¼	¼-18	NPTF	Stainless	1	2.16	1.00	0.69	54.86	25.40	17.53

Part Number	Coupling Type	Body Size	Port Size	Thread	Type	Material	Fig.	Dimensions					
								C (in)	D (in)	Hex (in)	C (mm)	D (mm)	Hex (mm)
10	Plug/Male	¼	¼	¼-18	NPTF	Steel	2	1.75	0.62	0.56	44.45	15.75	14.22
10C‡	Plug/Male	¼	¼	¼-18	NPTF	Steel	2	1.75	0.65	0.56	44.45	16.51	14.22
10G†	Plug/Male	¼	¼	¼-18	NPTF	Steel	2	1.75	0.65	0.56	44.45	16.51	14.22
12E	Plug/Male	¼	¼	¼-27	NPTF	Steel	2	1.59	0.58	0.50	40.38	14.73	12.7
12G†	Plug/Male	¼	¼	¼-27	NPTF	Steel	2	2.38	0.77	0.69	60.45	19.55	17.52
14	Plug/Male	¼	¾	¾-18	NPTF	Steel	2	1.75	0.79	0.69	44.45	20.06	17.52
14G†	Plug/Male	¼	¾	¾-18	NPTF	Steel	2	2.53	0.77	0.69	64.26	19.55	17.52
B10	Plug/Male	¼	¼	¼-18	NPTF	Brass	2	1.75	0.62	0.56	44.45	16.25	14.22
LL10	Plug/Male	¼	¼	¼-18	NPTF	Stainless	2	1.75	0.62	0.56	44.45	16.51	14.22
10NK*	Plug/Male	¼	¼	¼-18	NPTF	Steel	2	1.75	0.62	0.56	44.45	15.75	14.22

‡ With Ball Check † With Bleeder Ball Check—Reduces Hose Whip *Nickel plated

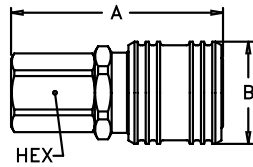

Figure 3

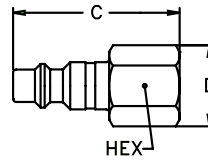

Figure 4

Female NPTF Connections

Part Number	Coupling Type	Body Size	Port Size	Thread	Type	Material	Fig.	Dimensions					
								A (in)	B (in)	Hex (in)	A (mm)	B (mm)	Hex (mm)
800E	Socket/Female	¼	¼	¼-27	NPTF	Brass	3	1.86	1.00	0.69	47.24	25.40	17.53
1000E	Socket/Female	¼	¼	¼-18	NPTF	Brass	3	2.08	1.00	0.69	52.83	25.40	17.53
1200	Socket/Female	¼	¾	¾-18	NPTF	Brass	3	2.16	1.00	0.75	54.86	25.40	19.05
LL1000	Socket/Female	¼	¼	¼-18	NPTF	Stainless	3	2.08	1.00	0.69	52.83	25.40	17.53

Part Number	Coupling Type	Body Size	Port Size	Thread	Type	Material	Fig.	Dimensions					
								C (in)	D (in)	Hex (in)	C (mm)	D (mm)	Hex (mm)
11	Plug/Male	¼	¼	¼-18	NPTF	Steel	4	1.63	0.79	0.69	41.40	20.07	17.53
11G†	Plug/Male	¼	¼	¼-18	NPTF	Steel	4	2.44	0.77	0.69	61.98	19.56	17.53
13	Plug/Male	¼	¼	¼-27	NPTF	Steel	4	1.47	0.65	0.56	37.34	16.51	14.22
15E	Plug/Male	¼	¾	¾-18	NPTF	Steel	4	1.69	0.94	0.81	42.93	23.88	20.57
11B	Plug/Male	¼	¼	¼-18	NPTF	Brass	4	1.63	0.78	0.69	41.40	19.81	17.53
LL11	Plug/Male	¼	¼	¼-18	NPTF	Stainless	4	1.63	0.79	0.69	41.40	20.07	17.53
11NK*	Plug/Male	¼	¼	¼-18	NPTF	Steel	4	1.63	0.79	0.69	41.40	20.07	17.53

† With Bleeder Ball Check—Reduces Hose Whip *Nickel plated

FLUID TRANSFER
AND HYDRAULIC

PNEUMATIC

SPECIAL APPLICATIONS

DIAGNOSTIC

AGRICULTURE

REFRIGERANT

1000 Series

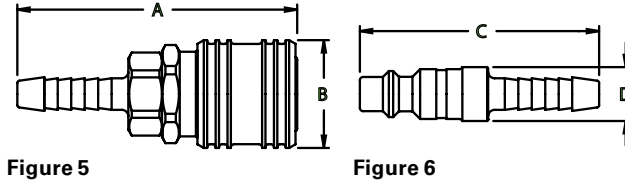

Figure 5

Figure 6

Hose Stem End Connections

Part Number	Coupling Type	Body Size	Hose I.D.	Material	Fig.	Dimensions		A	B
						A	B		
						(in)	(in)	(mm)	(mm)
1600E	Socket/Female	¼	¼	Brass	5	2.60	1.00	66.04	25.40
1600P‡	Socket/Female	¼	¼	Brass	5, 5A	2.37	1.00	60.20	25.40
1700E	Socket/Female	¼	⅜	Brass	5	2.60	1.00	66.04	25.40
1700P‡	Socket/Female	¼	⅜	Brass	5, 5A	2.44	1.00	61.98	25.40
1800	Socket/Female	¼	⅝	Brass	5	2.60	1.00	66.04	25.40

Part Number	Coupling Type	Body Size	Hose I.D.	Material	Fig.	Dimensions		C	D
						C	D		
						(in)	(in)	(mm)	(mm)
16	Plug/Male	¼	¼	Steel	6	2.22	0.50	56.39	12.70
16G†	Plug/Male	¼	¼	Steel	6	2.97	0.77	75.44	19.56
16P‡	Plug/Male	¼	¼	Steel	6, 6A	2.00	0.58	50.80	14.73
17	Plug/Male	¼	⅜	Steel	6	2.22	0.5	56.39	12.70
17G†	Plug/Male	¼	⅜	Steel	6	2.96	0.77	75.18	19.56
17P‡	Plug/Male	¼	⅜	Steel	6, 6A	2.06	0.5	52.32	12.70
18E	Plug/Male	¼	⅝	Steel	6	2.22	0.50	56.39	12.70
B17	Plug/Male	¼	⅜	Brass	6	2.22	0.5	56.39	12.70
16NK*	Plug/Male	¼	¼	Steel	6	2.22	0.50	56.39	12.70
17NK*	Plug/Male	¼	⅜	Steel	6	2.22	0.5	56.39	12.70

†With Bleeder Ball Check—Reduces Hose Whip ‡ For use with push-on style hose *Nickel plated

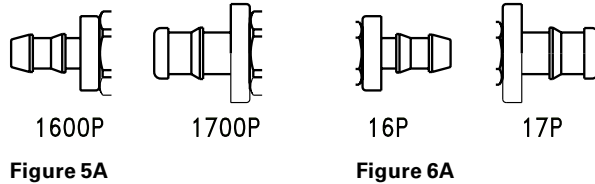

Figure 5A

Figure 6A

FLUID TRANSFER
AND HYDRAULIC

PNEUMATIC

SPECIAL APPLICATIONS

DIAGNOSTIC

AGRICULTURE

REFRIGERANT

1000 Series

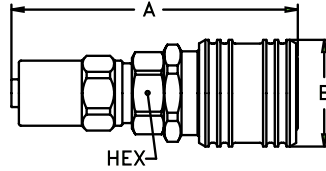

Figure 7

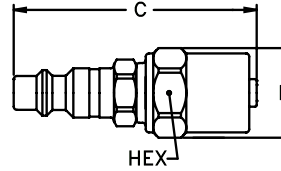

Figure 8

Hose Clamp End Connections

Part Number	Coupling Type	Body Size	Hose I.D.	Hose O.D.	Material	Fig.	Dimensions			A	B	Hex
							A	B	Hex			
							(in)	(in)	(in)	(mm)	(mm)	(mm)
1SB1	Socket/Female	¼	¼	1½/2	Brass	7	2.69	1.00	0.69	68.33	25.40	17.53
1SB3	Socket/Female	¼	¼	½	Brass	7	2.69	1.00	0.69	68.33	25.40	17.53
1SB5E	Socket/Female	¼	¼	5/16	Brass	7	2.69	1.00	0.69	68.33	25.40	17.53
1SB7	Socket/Female	¼	¼	3/8	Brass	7	2.69	1.00	0.69	68.33	25.40	17.53
1SC5	Socket/Female	¼	5/16	5/16	Brass	7	2.75	1.00	0.69	69.85	25.40	17.53
1SC7	Socket/Female	¼	5/16	3/8	Brass	7	2.75	1.00	0.69	69.85	25.40	17.53
1SC9	Socket/Female	¼	5/16	11/16	Brass	7	2.75	1.00	0.69	69.85	25.40	17.53
1SD5	Socket/Female	¼	3/8	5/16	Brass	7	2.81	1.00	0.69	71.37	25.40	17.53
1SD7	Socket/Female	¼	3/8	3/8	Brass	7	2.81	1.00	0.69	71.37	25.40	17.53
1SD9	Socket/Female	¼	3/8	11/16	Brass	7	2.81	1.00	0.69	71.37	25.40	17.53
1SD11	Socket/Female	¼	3/8	¾	Brass	7	2.81	1.00	0.69	71.37	25.40	17.53
Part Number	Coupling Type	Body Size	Hose I.D.	Hose O.D.	Material	Fig.	Dimensions			C	D	Hex
							C	D	Hex			
							(in)	(in)	(in)	(mm)	(mm)	(mm)
3PB1	Plug/Male	¼	¼	1½/2	Steel	8	2.31	0.70	0.63	58.67	17.78	16.00
3PB3	Plug/Male	¼	¼	½	Steel	8	2.31	0.70	0.63	58.67	17.78	16.00
3PB5	Plug/Male	¼	¼	5/16	Steel	8	2.31	0.77	0.69	58.67	19.56	17.53
3PB7	Plug/Male	¼	¼	3/8	Steel	8	2.31	0.84	0.75	58.67	21.34	19.05
3PB9	Plug/Male	¼	¼	11/16	Steel	8	2.31	0.94	0.81	58.67	23.88	20.57
3PB11	Plug/Male	¼	¼	¾	Steel	8	2.31	0.98	0.88	58.67	24.89	22.35
3PC5	Plug/Male	¼	5/16	5/16	Steel	8	2.38	0.77	0.69	60.45	19.56	17.53
3PC7	Plug/Male	¼	5/16	3/8	Steel	8	2.38	0.84	0.75	60.45	21.34	19.05
3PC9	Plug/Male	¼	5/16	11/16	Steel	8	2.38	0.91	0.81	60.45	23.11	20.57
3PD5	Plug/Male	¼	3/8	5/16	Steel	8	2.44	0.77	0.69	61.98	19.56	17.53
3PD7	Plug/Male	¼	3/8	3/8	Steel	8	2.44	0.84	0.75	61.98	21.34	19.05
3PD9	Plug/Male	¼	3/8	11/16	Steel	8	2.44	0.91	0.81	61.98	23.11	20.57
3PD11	Plug/Male	¼	3/8	¾	Steel	8	2.44	1.01	0.88	61.98	25.65	22.35

FLUID TRANSFER
AND HYDRAULIC

PNEUMATIC

SPECIAL APPLICATIONS

DIAGNOSTIC

AGRICULTURE

REFRIGERANT

G600 Series ISO 6150 B Interchange

FLUID TRANSFER
AND HYDRAULIC

PNEUMATIC

SPECIAL APPLICATIONS

DIAGNOSTIC

AGRICULTURE

REFRIGERANT



Eaton Gromelle™ G600 Series is a single shut-off compressed air coupling that incherchanges with ISO 6150 B and US A-A-59439 Standards requirements. Nominal diameter is 5.5 mm. Its new revamped design and the materials used make it a rugged and long-lasting coupling, offered in a wide selection of end connections. It is used in general pneumatic applications.

Product Features

- Automatic sleeve for one-hand push-to-connect operation with ball-locking mechanism
- Single shut-off valving
- Excellent flow capacity
- Easy to connect
- Shock-resistant ergonomic sleeve
- Standard body material (Socket): Nickel-plated brass
- Standard body material (Plug): Zinc trivalent-plated steel
- Standard seal material: NBR

Physical Characteristics

Body Size	Nominal Flow Diameter (mm)	Max. Operating Pressure		Air Flow Rate*				Working Temperature	
		(bar)	(psi)	Δp 0.6 bar/8.7 psi** (lpm)	(gpm)	Δp 1 bar/14.5 psi*** (lpm)	(gpm)	°C	°F
1/4	5.5	20	290	1,050	277	1,315	347	-20° +100°	-4° +212°

*Indicated values refer to an inlet pressure of 6 bar / 87 psi.

**This flow rate allows the optimum output from a pneumatic tool.

*** This flow rate is the maximum recommended for a suitable output from a pneumatic tool. For applications needing higher flow rates, it is recommended to select a larger size coupling.

Applications & Markets

- Compressed Air
- Pneumatic Tools

Flow Data

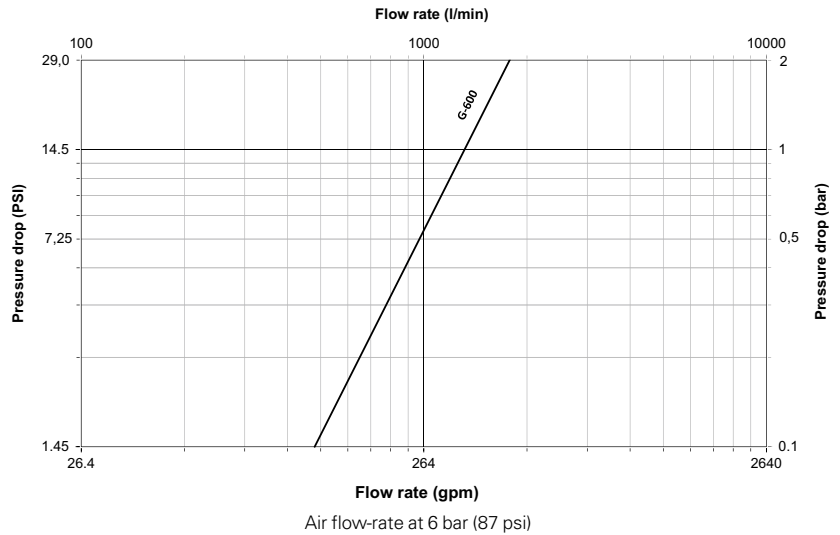

G600 Series ISO 6150 B Interchange

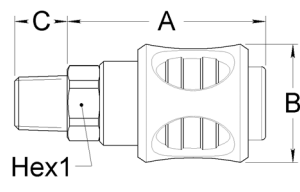

Figure 1

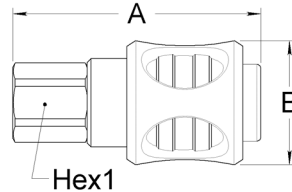

Figure 2

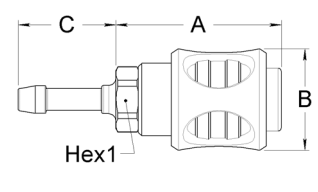

Figure 3

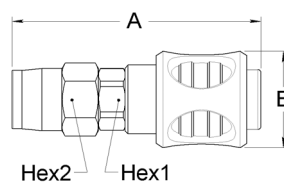

Figure 4

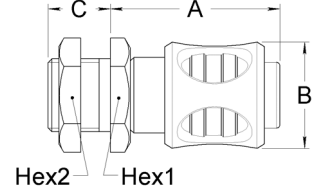

Figure 5

Sockets (Female)

Part Number	Body Size	Port Size	Thread or Hose Diam.*	Type	Fig.	Dimensions										Weight	
						A	B	C	Hex1	Hex2	A	B	C	Hex1	Hex2	lbs	g
						(in)	(in)	(in)	(in)	(in)	(mm)	(mm)	(mm)	(mm)	(mm)		
GL0063614		¼	¼-19	Male BSPT	1	1.93	1.14	0.51	0.67	-	49	29	13	17	-	0.23	103
GL0063638		⅜	⅜-19	Male BSPT	1	1.93	1.14	0.57	0.67	-	49	29	14.5	17	-	0.25	112
GL0063612		½	½-14	Male BSPT	1	1.89	1.14	0.67	0.87	-	48	29	17	22	-	0.28	126
GL0063645		M14	M14x1,25	Male Metric	1	1.93	1.14	0.51	0.67	-	49	29	13	17	-	0.23	105
GL0062614		¼	¼-19	Female BSPP	2	2.30	1.14	-	0.67	-	58.5	29	-	17	-	0.22	102
GL0062638		⅜	⅜-19	Female BSPP	2	2.42	1.14	-	0.87	-	61.5	29	-	22	-	0.27	121
GL0062645		M14	M14x1,25	Female Metric	2	2.34	1.14	-	0.67	-	59.5	29	-	17	-	0.22	101
GL0065667		-	6 mm	Hose Tail	3	1.87	1.14	1.10	0.67	-	47.5	29	28	17	-	0.22	99
GL0065678	¼	-	7 mm	Hose Tail	3	1.87	1.14	1.10	0.67	-	47.5	29	28	17	-	0.22	101
GL0065689		-	8 mm	Hose Tail	3	1.87	1.14	1.10	0.67	-	47.5	29	28	17	-	0.22	101
GL0065690		-	9 mm	Hose Tail	3	1.87	1.14	1.10	0.67	-	47.5	29	28	17	-	0.22	102
GL0065601		-	10 mm	Hose Tail	3	1.87	1.14	1.10	0.67	-	47.5	29	28	17	-	0.22	102
GL0061674		-	7x14 mm	Reusable Hose Fit.	4	2.95	1.14	-	0.67	0.75	75	29	-	17	19	0.30	134
GL0061684		-	8x14 mm	Reusable Hose Fit.	4	2.95	1.14	-	0.67	0.75	75	29	-	17	19	0.29	130
GL0061685		-	8x15 mm	Reusable Hose Fit.	4	2.95	1.14	-	0.67	0.75	75	29	-	17	19	0.28	126
GL0061696		-	9x16mm	Reusable Hose Fit.	4	2.95	1.14	-	0.67	0.75	75	29	-	17	19	0.28	128
GL0065014		¼	¼-19	Female BSPP Bulkhead**	5	1.83	1.14	0.67	1.06	1.06	46.5	29	17	27	27	0.33	148

To obtain connected length of coupling add dimensions A or A+C (Fig. 1, 2, 3, 4, 5) and D or D+E (Fig. 6, 7, 8, 9, 10) together and subtract 20 mm (0.79 in.)

*Alternative end connections available upon request.

**Max bulkhead thickness: 10 mm (0.39 in.) / Bulkhead hole diameter: 21 mm (0.83 in.)

FLUID TRANSFER
AND HYDRAULIC

PNEUMATIC

SPECIAL APPLICATIONS

DIAGNOSTIC

AGRICULTURE

REFRIGERANT

G600 Series ISO 6150 B Interchange

FLUID TRANSFER
AND HYDRAULIC

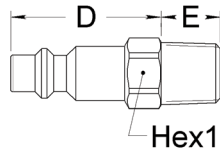

Figure 6

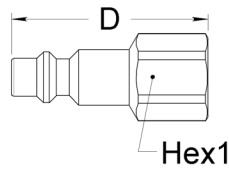

Figure 7

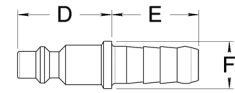

Figure 8

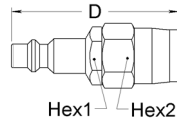

Figure 9

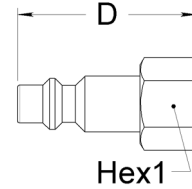

Figure 10

PNEUMATIC

Plug (Male)

Part Number	Body Size	Port Size	Thread or Hose Diam.*	Type	Dimensions											Weight	
					Fig.	D	E	F	Hex1	Hex2	D	E	F	Hex1	Hex2	lbs	g
						(in)	(in)	(in)	(in)	(in)	(mm)	(mm)	(mm)	(mm)	(mm)		
GA0066318		1/8	1/8-28	Male BSPT	6	1.26	0.35	-	0.47	-	32	9	-	12	-	0.04	19
GA0066314		1/4	1/4-19	Male BSPT	6	1.26	0.51	-	0.55	-	32	13	-	14	-	0.06	25
10		1/4	1/4-18	Male NPT	6	1.22	0.55	-	0.59	-	31	14	-	15	-	0.06	25
GA0066338		3/8	3/8-19	Male BSPT	6	1.26	0.59	-	0.67	-	32	15	-	17	-	0.08	38
GA0066345		M14	M14x1,25	Male Metric	6	1.26	0.51	-	0.55	-	32	13	-	14	-	0.06	26
GA0066214		1/4	1/4-19	Female BSPP	7	1.73	-	-	0.67	-	44	-	-	17	-	0.07	30
11		1/4	1/4-18	Female NPT	7	1.63	-	-	0.71	-	41.5	-	-	18	-	0.07	30
GA0066238		3/8	3/8-19	Female BSPP	7	1.73	-	-	0.83	-	44	-	-	21	-	0.08	37
GA0066245		M14	M14x1,25	Female Metric	7	1.73	-	-	0.67	-	44	-	-	17	-	0.06	25
GA0066248	1/4	-	M14x1,25	Female Metric	7	1.73	-	-	0.55	-	44	-	-	14	-	0.05	24
GA0066767		-	6 mm	Hose Tail	8	1.10	1.02	0.55	-	-	28	26	14	-	-	0.04	19
GA0066778		-	7 mm	Hose Tail	8	1.10	1.02	0.55	-	-	28	26	14	-	-	0.04	20
GA0066789		-	8 mm	Hose Tail	8	1.10	1.02	0.55	-	-	28	26	14	-	-	0.04	20
GA0066790		-	9 mm	Hose Tail	8	1.10	1.02	0.55	-	-	28	26	14	-	-	0.04	20
GA0066701		-	10 mm	Hose Tail	8	1.10	1.02	0.55	-	-	28	26	14	-	-	0.05	22
GA0066174		-	7x14 mm	Reusable Hose Fit.	9	2.22	-	-	0.63	0.75	56.5	-	-	16	19	0.12	56
GA0066184		-	8x14 mm	Reusable Hose Fit.	9	2.22	-	-	0.63	0.75	56.5	-	-	16	19	0.13	57
GA0066185		-	8x15 mm	Reusable Hose Fit.	9	2.22	-	-	0.63	0.75	56.5	-	-	16	19	0.12	53
GA0066196		-	9x16 mm	Reusable Hose Fit.	9	2.22	-	-	0.63	0.75	56.5	-	-	16	19	0.11	51
GA0066814		1/4	1/4-19	Female BSPP Swivel	10	1.50	-	-	0.67	-	38	-	-	17	-	0.06	26
GA0066845		M14	M14x1,25	Female Metric Swivel	10	1.50	-	-	0.67	-	38	-	-	17	-	0.06	26

To obtain connected length of coupling add dimensions A or A+C (Fig. 1, 2, 3, 4, 5) and D or D+E (Fig. 6, 7, 8, 9, 10) together and subtract 20 mm (0.79 in.)

*Alternative end connections available upon request.

AGRICULTURE

REFRIGERANT

G700 Series European Profile



Eaton Gromelle™ G700 Series is a single shut-off compressed air coupling with a European profile. Nominal diameter is 7.2/7.4 mm. This coupling offers an excellent flow capacity and is used in compressed air applications.

Product Features

- Automatic sleeve for one-hand push-to-connect operation with ball-locking mechanism
- Single shut-off valving
- Easy to connect
- Shock resistant ergonomic sleeve
- Standard body material (Socket): Nickel-plated brass
- Standard body material (Plug): Zinc trivalent-plated steel
- Standard seal material: NBR

Physical Characteristics

Body Size	Nominal Flow Diameter (mm)	Max. Operating Pressure		Air Flow Rate*				Working Temperature	
		(bar)	(psi)	Δp 0.6 bar/8.7 psi**	(lpm)	(gpm)	Δp 1 bar/14.5 psi***	(lpm)	(gpm)
1/4	7.3	20	290	1,550	410	1,960	520	-20° +100°	-4° +212°

*Indicated values refer to an inlet pressure of 6 bar / 87 psi.

**This flow rate allows the optimum output from a pneumatic tool.

***This flow rate is the maximum recommended for a suitable output from a pneumatic tool. For applications needing higher flow rates, it is recommended to select a larger size coupling.

Applications & Markets

- Compressed Air
- Pneumatic Tools

Flow Data

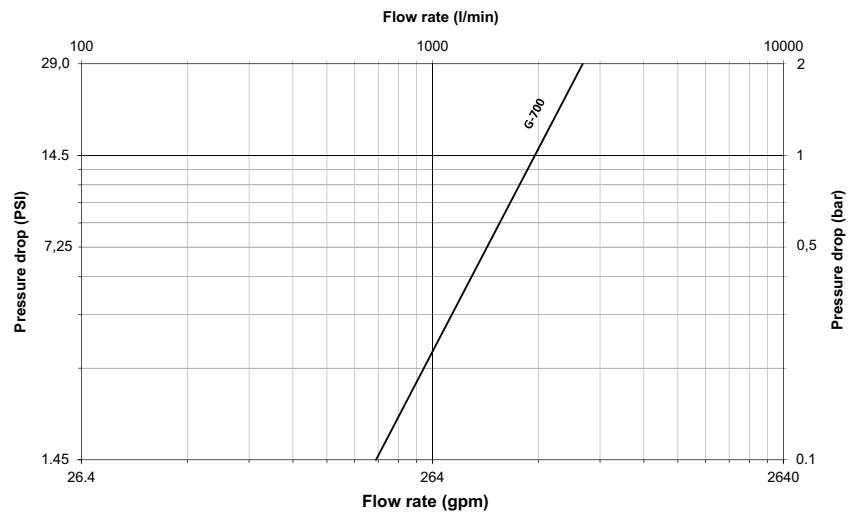

Air flow-rate at 6 bar (87 psi)

G700 Series European Profile

FLUID TRANSFER
AND HYDRAULIC

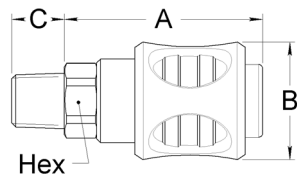

Figure 1

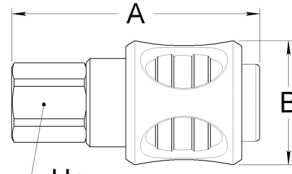

Figure 2

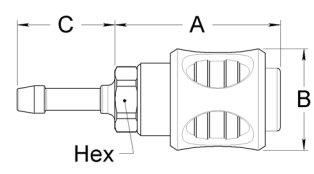

Figure 3

Sockets (Female)

Part Number	Body Size	Port Size	Thread or Hose Diam.*	Type	Fig.	Dimensions							Weight		
						A	B	C	Hex	A	B	C	Hex	lbs	g
						(in)	(in)	(in)	(in)	(mm)	(mm)	(mm)	(mm)		
GL0073614		¼	¼-19	Male BSPT	1	1.93	1.14	0.51	1	49	29	13	17	0.22	101
GL0073638		⅜	⅜-19	Male BSPT	1	1.93	1.14	0.57	1	49	29	14.5	17	0.24	110
GL0073612		½	½-14	Male BSPT	1	1.89	1.14	0.67	1	48	29	17	22	0.27	124
GL0072614		¼	¼-19	Female BSPP	2	2.30	1.14	-	0.7	58.5	29	-	17	0.22	102
GL0072638	¼	⅜	⅜-19	Female BSPP	2	2.42	1.14	-	0.7	61.5	29	-	17	0.26	120
GL0072612		½	½-14	Female BSPP	2	2.58	1.14	-	0.9	65.5	29	-	22	0.22	100
GL0075667		-	6 mm	Hose Tail	3	1.87	1.14	1.10	-	47.5	29	28	-	0.22	98
GL0075689		-	8 mm	Hose Tail	3	1.87	1.14	1.10	-	47.5	29	28	-	0.22	100
GL0075601		-	10 mm	Hose Tail	3	1.87	1.14	1.10	-	47.5	29	28	-	0.22	100
GL0075613		-	13 mm	Hose Tail	3	1.87	1.14	1.30	-	47.5	29	33	-	0.22	100

*Alternative end connections available upon request.

To obtain connected length of coupling add dimensions A or A+C (Fig. 1, 2, 3) and D or D+E (Fig. 4, 5, 6) together and subtract 19 mm (0.75 in.).

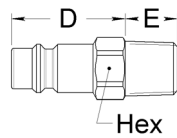

Figure 4

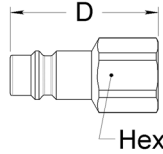

Figure 5

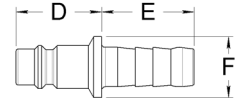

Figure 6

Plugs (Male)

Part Number	Body Size	Port Size	Thread or Hose Diam.*	Type	Fig.	Dimensions			Hex	D	E	F	Hex	Weight	
						D	E	F						(mm)	(mm)
						(in)	(in)	(in)	(in)	(mm)	(mm)	(mm)	(mm)		
GA0076314		¼	¼-19	Male BSPT	4	1.03	0.31	-	0.67	26.1	8	-	17	0.04	19
GA0076338		⅜	⅜-19	Male BSPT	4	0.99	0.35	-	0.75	25.0	9	-	19	0.05	23
GA0076312		½	½-14	Male BSPT	4	1.01	0.39	-	0.94	25.6	10	-	24	0.07	34
GA0076214		¼	¼-19	Female	5	1.30	-	-	0.67	33.0	-	-	17	0.05	21
GA0076238	¼	⅜	⅜-19	Female	5	1.32	-	-	0.75	33.5	-	-	19	0.05	21
GA0076212		½	½-14	Female	5	1.46	-	-	0.94	37.1	-	-	24	0.08	35
GA0076767		-	6 mm	Hose Tail	6	0.79	0.77	0.47	-	20.0	19.5	12	-	0.02	11
GA0076789		-	8 mm	Hose Tail	6	0.79	0.77	0.47	-	20.2	19.5	12	-	0.02	11
GA0076701		-	10 mm	Hose Tail	6	0.91	0.77	0.55	-	23.0	19.5	14	-	0.03	14
GA0076701		-	12 mm	Hose Tail	6	0.91	0.77	0.63	-	23.1	19.5	16	-	0.04	19

*Alternative end connections available upon request.

To obtain connected length of coupling add dimensions A or A+C (Fig. 1, 2, 3) and D or D+E (Fig. 4, 5, 6) together and subtract 19 mm (0.75 in.).

PNEUMATIC

SPECIAL APPLICATIONS

DIAGNOSTIC

AGRICULTURE

REFRIGERANT

1900 Series ISO 6150 B Interchange



Eaton Gromelle™ 1900 Series is a single shut-off compressed air coupling that interchanges with ISO 6150 B and US A-A-59439 Standards requirements. Nominal diameter is 8 mm.

Product Features

- Automatic sleeve for one-hand push-to-connect operation with ball-locking mechanism
- Single shut-off valving
- Excellent flow capacity
- Easy to connect
- Standard body material (Socket): Nickel-plated brass
- Standard body material (Plug): Zinc trivalent plated steel
- Standard seal material: NBR

Physical Characteristics

Body Size (in)	Nominal Flow Diameter (mm)	Max. Operating Pressure		Air Flow Rate*				Working Temperature	
		(bar)	(psi)	Δp 0.6 bar/8.7 psi**	(lpm)	(gpm)	Δp 1 bar/14.5 psi***	(lpm)	(gpm)
3/8	8	20	290	2,200	580	2,700	710	-20° +100°	-4° +212°

*Indicated values refer to an inlet pressure of 6 bar/87 psi.

**This flow rate allows the optimum output from a pneumatic tool.

***This flow rate is the maximum recommended for a suitable output from a pneumatic tool. For applications needing higher flow rates, it is recommended to select a larger size coupling.

Applications & Markets

- Compressed Air
- Pneumatic Tools

Flow Data

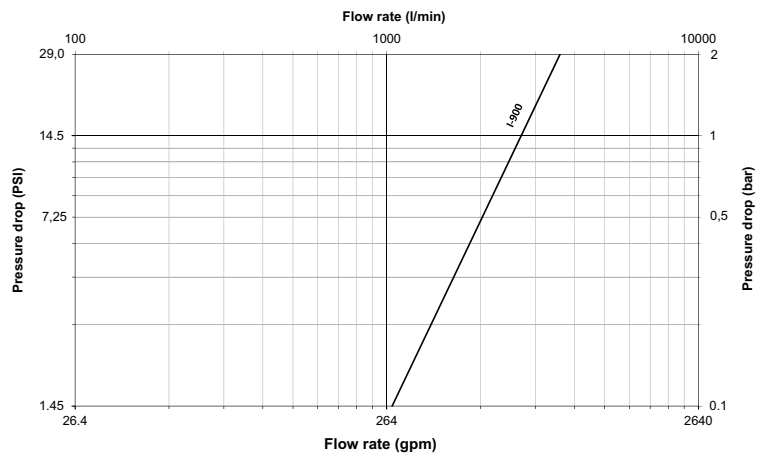

Air flow-rate at 6 bar (87 psi)

1900 Series ISO 6150 B Interchange

FLUID TRANSFER
AND HYDRAULIC

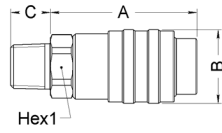

Figure 1

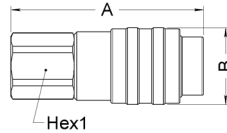

Figure 2

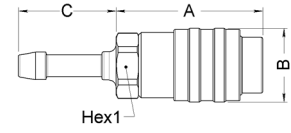

Figure 3

Sockets (Female)

Part Number	Body Size	Port Size	Thread or Hose Diam.*	Type	Fig.	Dimensions							Weight		
						A (in)	B (in)	C (in)	Hex1 (in)	A (mm)	B (mm)	C (mm)	Hex1 (mm)	lbs	g
IL0096014		¼	¼-19	Male BSPT	1	2.16	1.09	0.51	0.87	55	27.7	13	22	0.30	135
IL0096038		⅜	⅜-19	Male BSPT	1	2.16	1.09	0.59	0.87	55	27.7	15	22	0.31	139
IL0096012		½	½-14	Male BSPT	1	2.16	1.09	0.67	0.87	55	27.7	17	22	0.34	152
IL0097014		¼	¼-19	Female BSPP	2	2.64	1.09	-	0.87	67	27.7	-	22	0.34	153
IL0097038	⅜	⅜	⅜-19	Female BSPP	2	2.76	1.09	-	0.87	70	27.7	-	22	0.35	157
IL0097012		½	½-14	Female BSPP	2	2.87	1.09	-	1.06	73	27.7	-	27	0.41	187
IL0095689		-	8 mm	Hose Tail	3	2.20	1.09	1.10	0.87	56	27.7	28	22	0.30	135
IL0095690		-	9 mm	Hose Tail	3	2.20	1.09	1.10	0.87	56	27.7	28	22	0.30	138
IL0095601		-	10 mm	Hose Tail	3	2.20	1.09	1.10	0.87	56	27.7	28	22	0.31	139

To obtain connected length of coupling add dimensions A or A+C (Fig. 1, 2, 3) and D or D+E (Fig. 4, 5, 6) together and subtract 25,6 mm (1 in.)

*Alternative end connections available upon request.

PNEUMATIC

SPECIAL APPLICATIONS

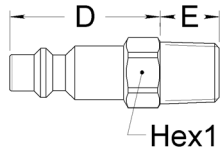

Figure 4

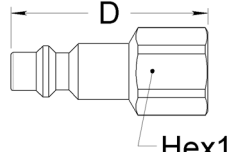

Figure 5

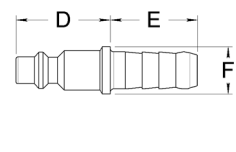

Figure 6

Plugs (Male)

Part Number	Body Size	Port Size	Thread or Hose Diam.*	Type	Fig.	Dimensions			Hex1			Weight			
						D (in)	E (in)	F (in)	D (in)	E (in)	F (in)	D (mm)	E (mm)	F (mm)	lbs
IA0090614		¼	¼-19	Male BSPT	4	1.34	0.51	-	0.63	34	13	-	16	0.07	32
IA0090638		⅜	⅜-19	Male BSPT	4	1.42	0.59	-	0.67	36	15	-	17	0.09	41
IA0090612		½	½-14	Male BSPT	4	1.57	0.67	-	0.91	40	17	-	23	0.12	56
IA0090714		¼	¼-19	Female BSPP	5	1.97	-	-	0.67	50	-	-	17	0.08	38
IA0090738		⅜	⅜-19	Female BSPP	5	1.97	-	-	0.83	50	-	-	21	0.11	49
IA0090712	⅜	½	½-14	Female BSPP	5	2.09	-	-	1.02	53	-	-	26	0.15	69
IA0090978		-	7 mm	Hose Tail	6	1.30	1.02	0.63	-	33	26	16	-	0.07	30
IA0090989		-	8 mm	Hose Tail	6	1.30	1.02	0.63	-	33	26	16	-	0.07	30
IA0090990		-	9 mm	Hose Tail	6	1.30	1.02	0.63	-	33	26	16	-	0.07	31
IA0090901		-	10 mm	Hose Tail	6	1.30	1.02	0.63	-	33	26	16	-	0.07	32
IA0090912		-	12 mm	Hose Tail	6	1.30	1.22	0.63	-	33	31	16	-	0.08	38

To obtain connected length of coupling add dimensions A or A+C (Fig. 1, 2, 3) and D or D+E (Fig. 4, 5, 6) together and subtract 25,6 mm (1 in.)

*Alternative end connections available upon request.

DIAGNOSTIC

AGRICULTURE

REFRIGERANT

I1000 Series European Profile



Eaton Gromelle™ I1000 Series is a single shut-off compressed air coupling with a European profile. This coupling offers excellent flow capacity and is used in many compressed air applications.

Product Features

- Automatic sleeve for one-hand push-to-connect operation with ball-locking mechanism
- Single shut-off valving
- Excellent flow capacity
- Easy to connect
- Standard body material (Socket): Nickel-plated brass
- Standard body material (Plug): Zinc trivalent plated steel
- Standard seal material: NBR

Physical Characteristics

Body Size (in)	Nominal Flow Diameter (mm)	Max. Operating Pressure		Air Flow Rate*				Working Temperature	
		(bar)	(psi)	Δp 0.6 bar/8.7 psi**	(lpm)	(gpm)	Δp 1 bar/14.5 psi***	(lpm)	(gpm)
3/8	10.3	20	290	3,000	790	3,700	980	-20° +100°	-4° +212°

*Indicated values refer to an inlet pressure of 6 bar / 87 psi.

**This flow rate allows the optimum output from a pneumatic tool.

***This flow rate is the maximum recommended for a suitable output from a pneumatic tool. For applications needing higher flow rates, it is recommended to select a larger size coupling.

Applications & Markets

- Compressed Air
- Pneumatic Tools

Flow Data

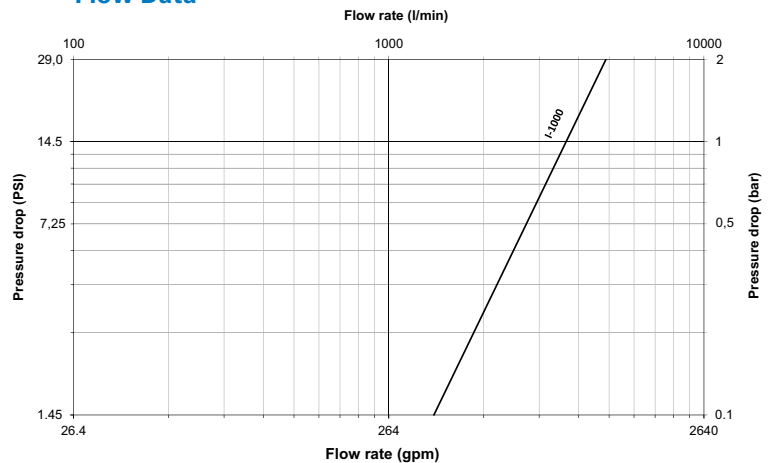

Air flow-rate at 6 bar (87 psi)

FLUID TRANSFER
AND HYDRAULIC

PNEUMATIC

SPECIAL APPLICATIONS

DIAGNOSTIC

AGRICULTURE

REFRIGERANT

I1000 Series European Profile

FLUID TRANSFER
AND HYDRAULIC

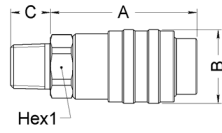

Figure 1

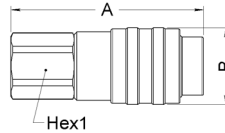

Figure 2

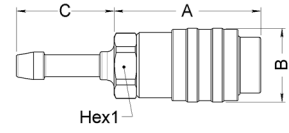

Figure 3

Sockets (Female)

Part Number	Body Size	Port Size	Thread or Hose Diam.*	Type	Dimensions Fig.	Dimensions									
						A	B	C	Hex1	A	B	C	Hex1	Weight lbs	g
IL0106014		¼	¼-19	Male BSPT	1	2.16	1.09	0.51	0.87	53	27.7	13	22	0.29	130
IL0106038		⅜	⅜-19	Male BSPT	1	2.16	1.09	0.59	0.87	53	27.7	15	22	0.30	134
IL0106012		½	½-14	Male BSPT	1	2.16	1.09	0.67	0.87	53	27.7	17	22	0.32	147
IL0107014		¼	¼-19	Female BSPP	2	2.64	1.09	-	0.87	65	27.7	-	22	0.33	148
IL0107038	⅜	⅜	⅜-19	Female BSPP	2	2.76	1.09	-	0.87	68	27.7	-	22	0.32	145
IL0107012		½	½-14	Female BSPP	2	2.87	1.09	-	1.06	71	27.7	-	27	0.40	182
IL0105689		-	8 mm	Hose Tail	3	2.20	1.09	1.10	0.87	54	27.7	28	22	0.29	130
IL0105690		-	9 mm	Hose Tail	3	2.20	1.09	1.10	0.87	54	27.7	28	22	0.29	133
IL0105601		-	10 mm	Hose Tail	3	2.20	1.09	1.10	0.87	54	27.7	28	22	0.30	134

To obtain connected length of coupling add dimensions A or A+C (Fig. 1, 2, 3) and D or D+E (Fig. 4, 5, 6) together and subtract 19,8 mm (0,78 in.)

*Alternative end connections available upon request.

PNEUMATIC

SPECIAL APPLICATIONS

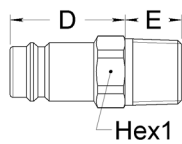

Figure 4

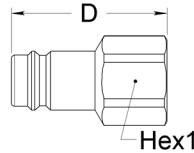

Figure 5

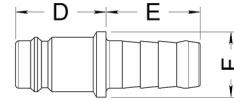

Figure 6

Plugs (Male)

Part Number	Body Size	Port Size	Thread or Hose Diam.*	Type	Fig.	Dimensions									
						D	E	F	Hex1	D	E	F	Hex1	Weight lbs	g
IA0100638		⅜	⅜-19	Male BSPT	4	1.16	0.57	-	0.67	29.5	14.5	-	17	0.08	38
IA0100612		½	½-14	Male BSPT	4	1.30	0.67	-	0.87	33	17	-	22	0.12	56
IA0100738		⅜	⅜-19	Female BSPP	5	1.57	-	-	0.83	40	-	-	21	0.09	41
IA0100712	⅜	½	½-14	Female BSPP	5	1.77	-	-	1.06	45	-	-	27	0.16	74
IA0100990		-	9 mm	Hose Tail	6	0.85	1.02	0.59	-	21.5	26	15	-	0.04	20
IA0100901		-	10 mm	Hose Tail	6	0.85	1.02	0.59	-	21.5	26	15	-	0.05	21
IA0100912		-	12 mm	Hose Tail	6	0.98	1.02	0.71	-	25	26	18	-	0.06	26

To obtain connected length of coupling add dimensions A or A+C (Fig. 1, 2, 3) and D or D+E (Fig. 4, 5, 6) together and subtract 19,8 mm (0,78 in.)

*Alternative end connections available upon request.

DIAGNOSTIC

AGRICULTURE

REFRIGERANT

T1100 Series ISO 6150 B Interchange



Eaton Gromelle™ T1100 Series is a single shut-off compressed air coupling that interchanges with ISO 6150 B and US A-A-59439 Standards requirements. This coupling offers excellent flow capacity and is used in many compressed air applications.

Product Features

- Automatic sleeve for one-hand push-to-connect operation with ball-locking mechanism
- Single shut-off valving
- Excellent flow capacity
- Easy to connect
- Standard body material (Socket): Nickel-plated brass
- Standard body material (Plug): Zinc trivalent plated steel
- Standard seal material: NBR

Physical Characteristics

Body Size (in)	Nominal Flow Diameter (mm)	Max. Operating Pressure		Air Flow Rate*				Working Temperature	
		(bar)	(psi)	Δp 0.6 bar/8.7 psi**	(lpm)	(gpm)	Δp 1 bar/14.5 psi***	(lpm)	(gpm)
1/2	11	20	290	3,450	910	4,300	1,130	-20° +100°	-4° +212°

*Indicated values refer to an inlet pressure of 6 bar/87 psi.

**This flow rate allows the optimum output from a pneumatic tool.

***This flow rate is the maximum recommended for a suitable output from a pneumatic tool. For applications needing higher flow rates, it is recommended to select a larger size coupling.

Applications & Markets

- Compressed Air
- Pneumatic Tools

Flow Data

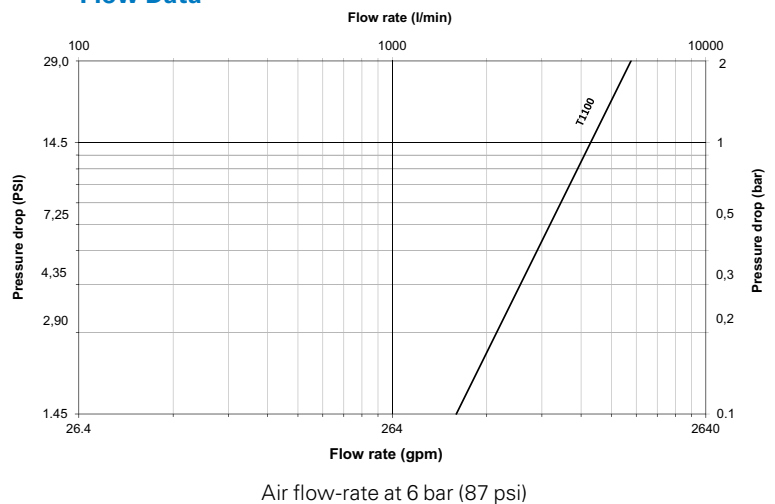

T1100 Series ISO 6150 B Interchangeable

FLUID TRANSFER
AND HYDRAULIC

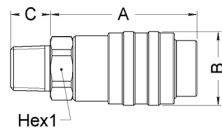

Figure 1

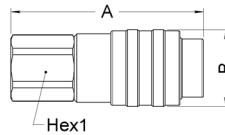

Figure 2

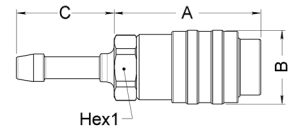

Figure 3

Sockets (Female)

Part Number	Body Size	Port Size	Thread or Hose Diam.*	Type	Dimensions Fig.	Dimensions							Weight		
						A	B	C	Hex1	A	B	C		Hex1	
						(in)	(in)	(in)	(in)	(mm)	(mm)	(mm)	(mm)	lbs	g
TL0112038		3/8	3/8-19	Male BSPT	1	2.80	1.32	0.59	1.06	71	33.6	15	27	0.58	265
TL0112012		1/2	1/2-14	Male BSPT	1	2.80	1.32	0.67	1.06	71	33.6	17.0	27	0.60	270
TL0112034		3/4	3/4-14	Male BSPT	1	2.80	1.32	0.73	1.14	71	33.6	18.5	29	0.63	288
TL0112138	1/2	3/8	3/8-19	Female BSPP	2	3.29	1.32	-	1.06	83.5	33.6	-	27	0.63	286
TL0112112		1/2	1/2-14	Female BSPP	2	3.29	1.32	-	1.06	83.5	33.6	-	27	0.59	266
TL0112134		3/4	3/4-14	Female BSPP	2	3.52	1.32	-	1.26	89.5	33.6	-	32	0.69	312
TL0115601		-	10 mm	Hose Tail	3	2.85	1.32	1.10	1.06	72.5	33.6	28	27	0.58	264
TL0115613		-	13 mm	Hose Tail	3	2.85	1.32	1.30	1.06	72.5	33.6	33	27	0.60	274
TL0115616		-	16 mm	Hose Tail	3	2.85	1.32	1.30	1.06	72.5	33.6	33	27	0.62	279

To obtain connected length of coupling add dimensions A or A+C (Fig. 1, 2, 3) and D or D+E (Fig. 4, 5, 6) together and subtract 34 mm (1,34 in.)

*Alternative end connections available upon request.

PNEUMATIC

SPECIAL APPLICATIONS

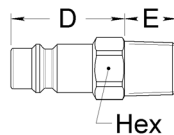

Figure 4

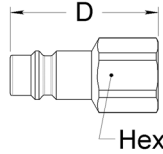

Figure 5

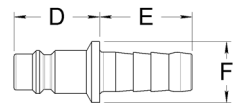

Figure 6

Plugs (Male)

Part Number	Body Size	Port Size	Thread or Hose Diam.*	Type	Dimensions Fig.	Dimensions			Hex1	D	E	F	Hex1	Weight	
						D	E	F							
						(in)	(in)	(in)	(in)	(mm)	(mm)	(mm)	(mm)	lbs	g
TA0111538		3/8	3/8-19	Male BSPT	4	1.71	0.57	-	0.67	43.5	14.5	-	17	0.11	51
TA0111512		1/2	1/2-14	Male BSPT	4	1.81	0.67	-	0.87	46	17	-	22	0.15	70
TA0111638		3/8	3/8-19	Female BSPP	5	2.09	-	-	0.83	53	-	-	21	0.12	55
TA0111612	1/2	1/2	1/2-14	Female BSPP	5	2.28	-	-	1.06	58	-	-	27	0.19	88
TA0111813		-	13 mm	Hose Tail	6	1.54	1.02	0.75	-	39	26	19	-	0.09	43
TA0111816		-	16 mm	Hose Tail	6	1.54	1.02	0.87	-	39	26	22	-	0.10	47
TA0111819		-	19 mm	Hose Tail	6	1.54	1.02	0.98	-	39	26	25	-	0.11	51

To obtain connected length of coupling add dimensions A or A+C (Fig. 1, 2, 3) and D or D+E (Fig. 4, 5, 6) together and subtract 34 mm (1,34 in.)

*Alternative end connections available upon request.

DIAGNOSTIC

AGRICULTURE

REFRIGERANT

T1300 Series Proprietary Profile



Eaton Gromelle™ T1300 Series is a proprietary profile single shut-off compressed air coupling. This coupling offers excellent flow capacity and is used in high flow compressed air applications.

Product Features

- Automatic sleeve for one-hand push-to-connect operation with ball-locking mechanism
- Single shut-off valving
- Excellent flow capacity
- Easy to connect
- Standard body material (Socket): Nickel-plated brass
- Standard body material (Plug): Zinc trivalent plated steel
- Standard seal material: NBR

Physical Characteristics

Body Size (in)	Nominal Flow Diameter (mm)	Max. Operating Pressure		Air Flow Rate*				Working Temperature	
		(bar)	(psi)	Δp 0.6 bar/8.7 psi**	(lpm)	(gpm)	Δp 1 bar/14.5 psi***	(lpm)	(gpm)
1/2	12	20	290	3,800	1,000	4,600	1,210	-20° +100°	-4° +212°

*Indicated values refer to an inlet pressure of 6 bar / 87 psi.

**This flow rate allows the optimum output from a pneumatic tool.

***This flow rate is the maximum recommended for a suitable output from a pneumatic tool. For applications needing higher flow rates, it is recommended to select a larger size coupling.

Applications & Markets

- Compressed Air
- Pneumatic Tools

Flow Data

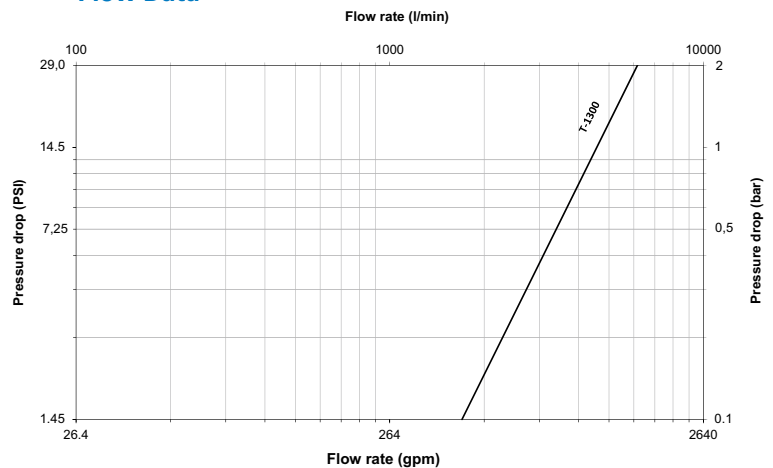

Air flow-rate at 6 bar (87 psi)

T1300 Series Proprietary Profile

FLUID TRANSFER
AND HYDRAULIC

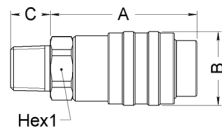

Figure 1

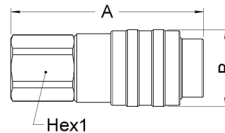

Figure 2

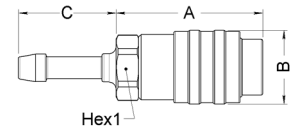

Figure 3

Sockets (Female)

Part Number	Body Size	Port Size	Thread or Hose Diam.*	Type	Fig.	Dimensions									
						A (in)	B (in)	C (in)	Hex1 (in)	A (mm)	B (mm)	C (mm)	Hex1 (mm)	Weight (lbs)	Weight (g)
TL0132038		3/8	3/8-19	Male BSPT	1	2.74	1.32	0.59	1.06	69.7	33.6	15	27	0.54	247
TL0132012		1/2	1/2-14	Male BSPT	1	2.74	1.32	0.67	1.06	69.7	33.6	17.0	27	0.56	255
TL0132034		3/4	3/4-14	Male BSPT	1	2.74	1.32	0.73	1.14	69.7	33.6	18.5	29	0.62	279
TL0132138	1/2	3/8	3/8-19	Female BSPP	2	3.24	1.32	-	1.06	82.2	33.6	-	27	0.60	272
TL0132112		1/2	1/2-14	Female BSPP	2	3.24	1.32	-	1.06	82.2	33.6	-	27	0.60	270
TL0132134		3/4	3/4-14	Female BSPP	2	3.47	1.32	-	1.26	88.2	33.6	-	32	0.65	295
TL0135601		-	10 mm	Hose Tail	3	2.80	1.32	1.10	1.06	71.2	33.6	28	27	0.55	249
TL0135613		-	13 mm	Hose Tail	3	2.80	1.32	1.30	1.06	71.2	33.6	33	27	0.57	259
TL0135616		-	16 mm	Hose Tail	3	2.80	1.32	1.30	1.06	71.2	33.6	33	27	0.58	264

To obtain connected length of coupling add dimensions A or A+C (Fig. 1, 2, 3) and D or D+E (Fig. 4, 5, 6) together and subtract 32,5 mm (1,28 in.)

*Alternative end connections available upon request.

PNEUMATIC

SPECIAL APPLICATIONS

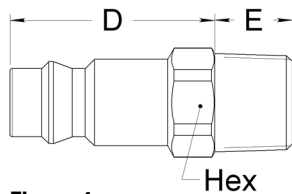

Figure 4

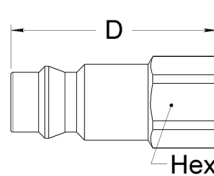

Figure 5

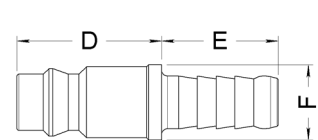

Figure 6

Plugs (Male)

Part Number	Body Size	Port Size	Thread or Hose Diam.*	Type	Fig.	Dimensions									
						D (in)	E (in)	F (in)	Hex1 (in)	D (mm)	E (mm)	F (mm)	Hex1 (mm)	Weight (lbs)	Weight (g)
TA0131538		3/8	3/8-19	Male BSPT	4	1.75	0.59	-	0.83	44.5	15	-	21	0.14	65
TA0131512		1/2	1/2-14	Male BSPT	4	1.83	0.67	-	0.87	46.5	17	-	22	0.19	85
TA0131638		3/8	3/8-19	Female BSPP	5	2.17	-	-	0.83	55	-	-	21	0.14	65
TA0131612	1/2	1/2	1/2-14	Female BSPP	5	2.48	-	-	1.02	63	-	-	26	0.21	95
TA0131813		-	13 mm	Hose Tail	6	1.52	1.22	0.79	-	38.5	31	20	-	0.13	57
TA0131816		-	16 mm	Hose Tail	6	1.52	1.46	0.79	-	38.5	37	20	-	0.15	70
TA0131819		-	19 mm	Hose Tail	6	1.52	1.65	1.06	-	38.5	42	27	-	0.19	87

To obtain connected length of coupling add dimensions A or A+C (Fig. 1, 2, 3) and D or D+E (Fig. 4, 5, 6) together and subtract 32,5 mm (1,28 in.)

*Alternative end connections available upon request.

DIAGNOSTIC

AGRICULTURE

REFRIGERANT

Blow-Guns



Eaton offers two styles of blow-guns to fit your application needs.

Product Features

100 Series

- Progressive flow-control
- The airtight version protects the operator against particle blow-back
- Body material: Nickel-plated brass
- Seals: NBR

200 Series

- Pressure reduces to 2 bar(30 PSI) if the nozzle is obstructed by an obstacle
- Complies with OSHA STD 01-13-2001 standard
- When in use, the gun is designed to produce low noise levels with the comfort of the operator in mind. Complies with Directive 2003/10/EC and OSHA 1910.95(b) standard

- The "soft touch" trigger and ergonomic design make it easy to grip and handle, even with work gloves. The graduated-opening system enables the operator to adjust the flow rate to his/her requirements.
- Body material: Nylon
- Nozzle: Stainless steel
- Seals: NBR

Physical Characteristics

Series	Type	Connection	Max. Operating Pressure		Temperature Range	
			(bar)	(psi)	C	F
100	Metal	G ¼	20	290	+100C/ -20C	+212F/-4F
200	Plastic	G ¼	10	145	+70C/-20C	+158F/-4F

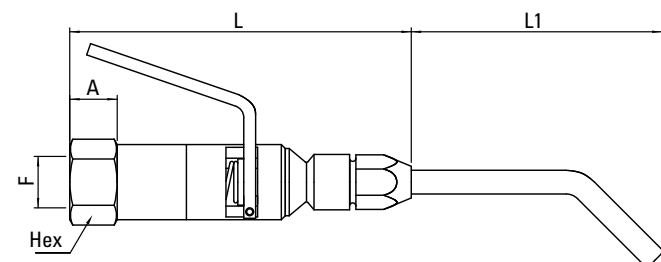

Figure 1

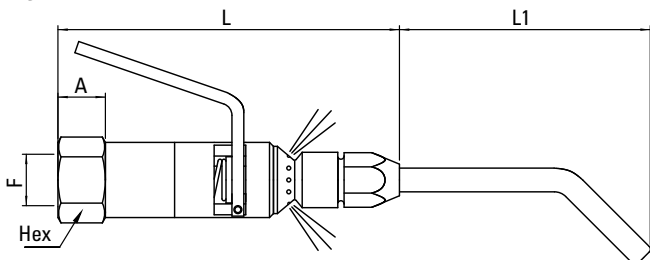

Figure 2

Series 100

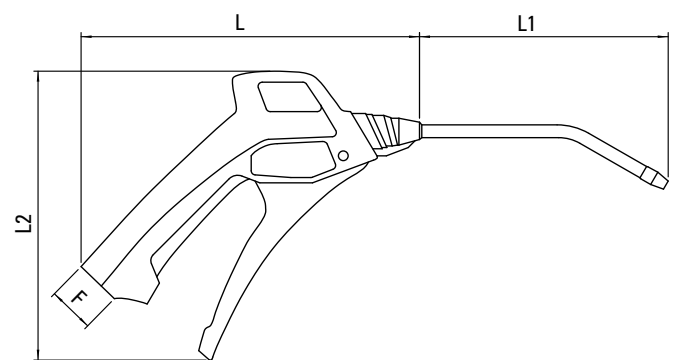

Figure 3

Series 200

Applications & Markets

- Pneumatic
- Manufacturing and Assembly

Series	Part Number	Description	Fig.	F	L	L1	Hex	A	Weight
				(mm)	(mm)	(mm)	(mm)	(g)	
100	SA0017014	Progressive-flow blow-gun	1	G¼	90	65	19	12	150
100	SA0017514	Blow-gun with airtight	2	G¼	90	65	19	12	150

Series	Part Number	Description	Fig.	F	L	L1	L2	Weight
				(mm)	(mm)	(mm)	(g)	
200	SP0020014	Blow-gun with metal nozzle	3	G¼	153	105	130	140

Adapters

FLUID TRANSFER AND HYDRAULIC

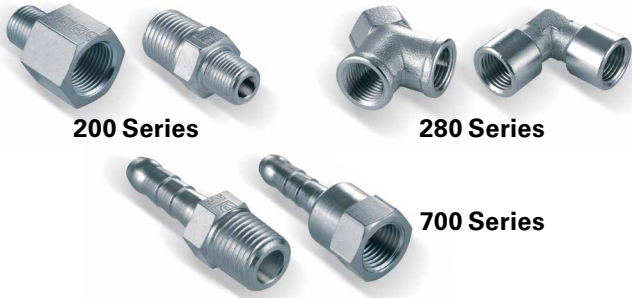

200 Series

280 Series

700 Series

PNEUMATIC

Product Features

200 Series

- Zinc-plated steel

280 Series

- Nickel-plated brass

700 Series

- Zinc-plated steel
- *EL is brass

SPECIAL APPLICATIONS

Physical Characteristics

Series	Max. Operating Pressure	
	(bar)	(psi)
200	120-250	1740-3625
280	60	870
700	35	508

DIAGNOSTIC

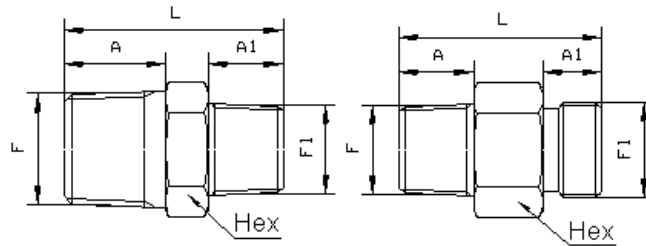

Figure 1

Figure 2

AGRICULTURE

200 Series

Male BSP Taper Nipple

Connection F	Connection F1	Part Number	Fig.	Dimensions				Weight (g)	Pressure (bar)
				L (mm)	A (mm)	Hex (mm)	A1 (mm)		
R 1/8	R 1/8	MA0024318	1	26	10	12	10	13	250
R 1/4	R 1/8	MA0024484	1	31	14	14	10	20	250
R 3/8	R 1/8	MA0024588	1	32	15	17	9	29	250
R 1/4	R 1/4	MA0024314	1	35	14	14	14	25	250
R 3/8	R 1/4	MA0024448	1	36	15	17	14	34	250
R 1/2	R 1/4	MA0024524	1	41	19	22	14	62	250
R 3/8	R 3/8	MA0024338	1	37	15	17	15	39	250
R 1/2	R 3/8	MA0024482	1	42	19	22	15	67	250
R 3/4	R 3/8	MA0024548	1	44	20	27	15	95	175
R 1/2	R 1/2	MA0024312	1	46	19	22	19	68	250
R 3/4	R 1/2	MA0024424	1	48	20	27	19	94	175
R 1	R 1/2	MA0024512	1	53	24	36	19	191	150
R 3/4	R 3/4	MA0024334	1	49	20	27	20	107	175
R 1	R 3/4	MA0024441	1	54	24	36	20	182	150
R 1	R 1	MA0024310	1	58	24	36	24	205	150

REFRIGERANT

Male BSP Taper/Metric Male Nipple

Connection F	Connection F1	Part Number	Fig.	Dimensions				Weight (g)	Pressure (bar)
				L (mm)	A (mm)	Hex (mm)	A1 (mm)		
R 1/4	M 14 x 1.25	MA0024145	2	31	13	16	12	24	250
R 3/8	M 18 x 1.25	MA0024188	2	33	14	22	11	44	250

Adapters

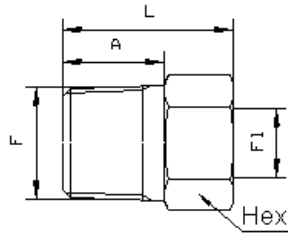

Figure 3

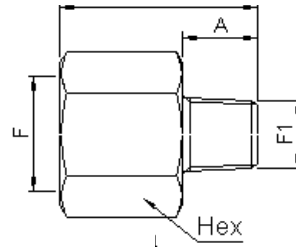

Figure 4

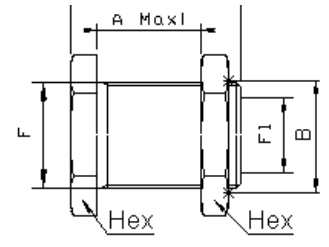

Figure 5

FLUID TRANSFER
AND HYDRAULIC

200 Series (cont.)

Reducing Bush

Connection F	Connection F1	Part Number	Fig.	Dimensions				Weight	Pressure
				L	A	Hex	A1		
				(mm)	(mm)	(mm)	(mm)	(g)	(bar)
R 1/4	G 1/8	MA0025548	3	21	14	14	-	14	250
R 3/8	G 1/8	MA0025688	3	22	15	17	-	27	250
R 3/8	G 1/4	MA0025584	3	23	15	19	-	20	250
R 1/2	G 1/4	MA0025624	3	27	19	22	-	49	250
R 1/2	G 3/8	MA0025528	3	27	19	22	-	37	250
R 3/4	G 3/8	MA0025648	3	29	20	27	-	77	175
R 3/4	G 1/2	MA0025542	3	29	20	27	-	52	175
R 1	G 1/2	MA0025612	3	34	24	36	-	139	150
R 1	G 3/4	MA0025514	3	34	24	36	-	100	150

Female/Male Reducer

Connection F	Connection F1	Part Number	Fig.	Dimensions				Weight	Pressure
				L	A	Hex	A1		
				(mm)	(mm)	(mm)	(mm)	(g)	(bar)
G 1/4	R 1/8	MA0024248	4	31	10	19	-	40	250
G 3/8	R 1/8	MA0026888	4	32	10	22	-	49	250
G 3/8	R 1/4	MA0024284	4	35	14	22	-	46	250
G 1/2	R 1/4	MA0026824	4	41	14	27	-	84	250
G 1/2	R 3/8	MA0024228	4	40	15	27	-	80	250
G 3/4	R 3/8	MA0026848	4	44	15	36	-	172	175
G 3/4	R 1/2	MA0024242	4	47	19	32	-	125	175
G 1	R 1/2	MA0026812	4	56	19	41	-	230	150
G 1	R 3/4	MA0024214	4	55	20	41	-	240	150

Bulkhead Reducer

Connection F	Connection F1	Part Number	Fig.	Dimensions				Weight	Pressure
				L	A Max.	Hex	B		
				(mm)	(mm)	(mm)	(mm)	(g)	(bar)
G 1/4	G 1/8	MA0027848	5	20	14	19	13.5	17	250
G 3/8	G 1/4	MA0027884	5	28	20	22	17	29	250
G 1/2	G 3/8	MA0027828	5	32	21	26	21.5	46	250
G 3/4	G 1/2	MA0027842	5	36	24	32	27	86	120

PNEUMATIC

SPECIAL APPLICATIONS

DIAGNOSTIC

AGRICULTURE

REFRIGERANT

Adapters

FLUID TRANSFER
AND HYDRAULIC

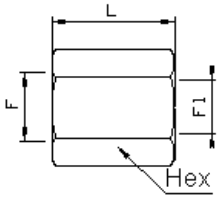

Figure 1

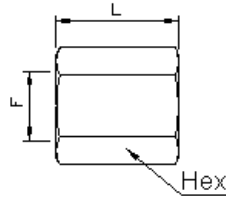

Figure 2

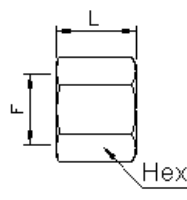

Figure 3

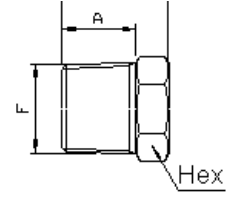

Figure 4

200 Series (cont.)

Reducing Socket

Connection F	Connection F1	Part Number	Fig.	Dimensions		Hex	A1	Weight	Pressure
				L	A				
				(mm)	(mm)	(mm)	(mm)	(g)	(bar)
G 1/4	G 3/8	MA0026748	1	24	-	19	-	39	250
G 3/8	G 1/2	MA0026784	1	27	-	22	-	53	250
G 1/2	G 3/4	MA0026728	1	32	-	27	-	89	250
G 3/4	G 1	MA0026742	1	36	-	32	-	126	175
G 1	G 3/4	MA0026714	1	45	-	41	-	131	150

Equal Socket

Connection F	Connection F1	Part Number	Fig.	Dimensions		Hex	A1	Weight	Pressure
				L	A				
				(mm)	(mm)	(mm)	(mm)	(g)	(bar)
G 3/8	-	MA0026918	2	20	-	14	-	17	250
G 1/4	-	MA0026914	2	25	-	19	-	35	250
G 3/8	-	MA0026938	2	27	-	22	-	45	250
G 1/2	-	MA0026912	2	35	-	27	-	76	250
G 3/4	-	MA0026934	2	40	-	32	-	113	175
G 1	-	MA0026910	2	45	-	41	-	217	150

Female-Threaded Cap

Connection F	Connection F1	Part Number	Fig.	Dimensions		Hex	A1	Weight	Pressure
				L	A				
				(mm)	(mm)	(mm)	(mm)	(g)	(bar)
G 3/8	-	MA0024618	3	17	-	14	-	23	250
G 1/4	-	MA0024614	3	22	-	19	-	29	250
G 3/8	-	MA0024638	3	24	-	22	-	38	250
G 1/2	-	MA0024612	3	30	-	27	-	70	250
G 3/4	-	MA0024634	3	32	-	32	-	91	175
G 1	-	MA0024610	3	41	-	41	-	176	150

Male-Threaded Cap

Connection F	Connection F1	Part Number	Fig.	Dimensions		Hex	A1	Weight	Pressure
				L	A				
				(mm)	(mm)	(mm)	(mm)	(g)	(bar)
R 1/8	-	MA0026618	4	16	10	12	-	10	250
R 1/4	-	MA0026614	4	21	14	14	-	22	250
R 3/8	-	MA0026638	4	22	15	17	-	31	250
R 1/2	-	MA0026612	4	27	19	22	-	55	250
R 3/4	-	MA0026634	4	29	20	27	-	89	175
R 1	-	MA0026610	4	34	24	36	-	164	150

PNEUMATIC

SPECIAL APPLICATIONS

DIAGNOSTIC

AGRICULTURE

REFRIGERANT

Adapters

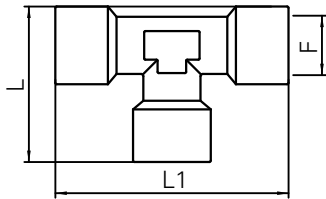

Figure 1

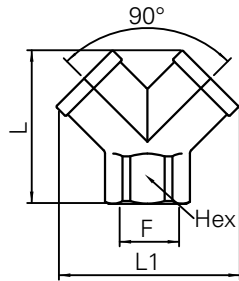

Figure 2

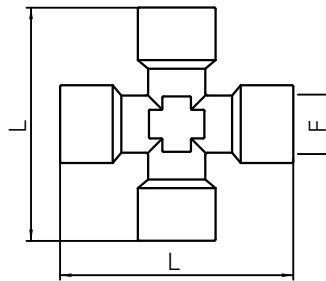

Figure 3

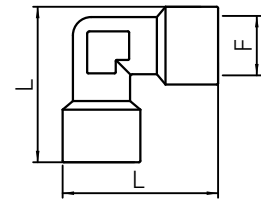

Figure 4

280 Series

Female Tee

Connection F	Connection F1	Part Number	Fig.	Dimensions			Weight
				L	L1	Hex	
				(mm)	(mm)	(mm)	(g)
G 1/8	-	ML0028018	1	28	42	-	28
G 1/4	-	ML0028014	1	34	51	-	57
G 3/8	-	ML0028038	1	39	56	-	83
G 1/2	-	ML0028012	1	46	67	-	144
G 3/4	-	ML0028034	1	53	73	-	201
G 1	-	ML0028010	1	64	90	-	321

Female Y-piece

Connection F	Connection F1	Part Number	Fig.	Dimensions			Weight
				L	L1	Hex	
				(mm)	(mm)	(mm)	(g)
G 1/8	-	ML0028618	2	27	29	13	19
G 1/4	-	ML0028614	2	32	36	17	34
G 3/8	-	ML0028638	2	37	41	20	44
G 1/2	-	ML0028612	2	45	53	25	93

Female Cross

Connection F	Connection F1	Part Number	Fig.	Dimensions			Weight
				L	L1	Hex	
				(mm)	(mm)	(mm)	(g)
G 1/8	-	ML0028118	3	42	-	-	48
G 1/4	-	ML0028114	3	51	-	-	73
G 3/8	-	ML0028138	3	56	-	-	107
G 1/2	-	ML0028112	3	67	-	-	185

90 Degree Female Elbow

Connection F	Connection F1	Part Number	Fig.	Dimensions			Weight
				L	L1	Hex	
				(mm)	(mm)	(mm)	(g)
G 1/8	-	ML0028218	4	28	-	-	21
G 1/4	-	ML0028214	4	34	-	-	40
G 3/8	-	ML0028238	4	39	-	-	58
G 1/2	-	ML0028212	4	47	-	-	106
G 3/4	-	ML0028234	4	50	-	-	130
G 1	-	ML0028210	4	64	-	-	227

FLUID TRANSFER
AND HYDRAULIC

PNEUMATIC

SPECIAL APPLICATIONS

DIAGNOSTIC

AGRICULTURE

REFRIGERANT

Adapters

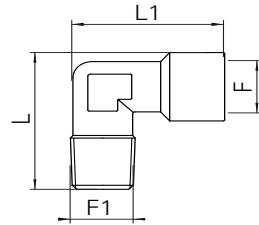

Figure 5

280 Series (cont.)

90 Degree Male/Female Elbow

Connection F	Connection F1	Part Number	Fig.	Dimensions		Hex	Weight
				L	L1		
				(mm)	(mm)	(mm)	(g)
G 1/8	-	ML0028418	5	26	26	-	17
G 1/4	-	ML0028414	5	32	32	-	34
G 3/8	-	ML0028438	5	37	37	-	50
G 1/2	-	ML0028412	5	44	44	-	89
G 3/4	-	ML0028434	5	50	50	-	124
G 1	-	ML0028410	5	60	60	-	206

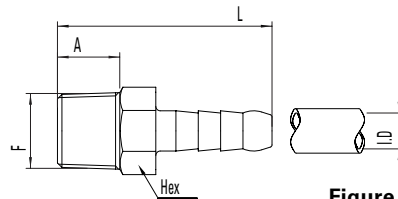

Figure 1

700 Series

Male-Threaded Hose Tail

Connection F	Hose I.D.	Part Number	Fig.	Dimensions		Hex	Weight
				L	A		
				(mm)	(mm)	(mm)	(g)
R 1/8	6	EL0070267	1	32	7.5	12	10
R 1/8	7	EA0070278	1	41	9	14	15
R 1/8	8	EA0070289	1	41	9	14	16
R 1/8	9	EA0070290	1	41	9	14	18
R 1/4	6	EA0070467	1	45	13	14	18
R 1/4	7	EA0070478	1	45	13	14	19
R 1/4	8	EA0070489	1	45	13	14	20
R 1/4	9	EA0070490	1	45	13	14	20
R 1/4	10	EA0070401	1	45	13	14	21
R 1/4	11	EA0070411	1	50	13	14	24
R 1/4	12	EA0070412	1	50	13	17	31
R 1/4	13	EA0070413	1	50	13	17	36
R 3/8	7	EA0070678	1	48	14	17	31
R 3/8	8	EA0070689	1	48	14	17	32
R 3/8	9	EA0070690	1	48	14	17	33
R 3/8	10	EA0070601	1	48	14	17	33
R 3/8	11	EA0070611	1	49	14	17	33
R 3/8	12	EA0070612	1	53	14	17	36
R 3/8	13	EA0070613	1	53	14	19	43
R 3/8	16	EA0070616	1	60	14	19	50
R 1/2	8	EA0070889	1	52	17	22	50
R 1/2	11	EA0070811	1	57	17	22	55
R 1/2	12	EA0070812	1	57	17	22	55
R 1/2	13	EA0070813	1	57	17	22	58
R 1/2	16	EA0070816	1	63	17	22	61
R 1/2	19	EA0070819	1	69	17	22	73
R 3/4	16	EA0071016	1	65	19	27	85
R 3/4	19	EA0071019	1	71	19	27	100
R 3/4	25	EA0071025	1	77	19	27	130
R 1	19	EA0072019	1	76	22	35	165
R 1	25	EA0072025	1	82	22	35	203
R 1	30	EA0072030	1	94	22	35	270

Adapters

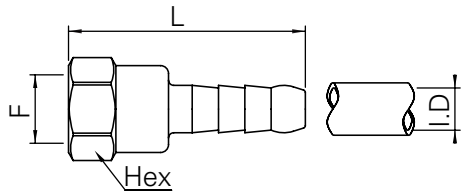

Figure 2

700 Series (cont.)

Female-Threaded Hose Tail

Connection F	Hose I.D. (mm)	Part Number	Fig.	Dimensions		Hex (mm)	Weight (g)
				L (mm)	A (mm)		
G ¼	6	EA0078167	2	45	-	17	23
G ¼	7	EA0078178	2	45	-	17	23
G ¼	8	EA0078189	2	45	-	17	25
G ¼	9	EA0078190	2	45	-	17	26

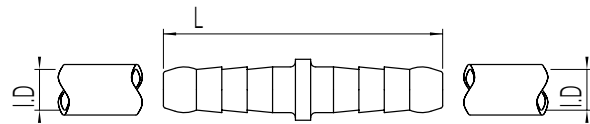

Figure 3

Hose Splicer

Connection F	Hose I.D. (mm)	Part Number	Fig.	Dimensions		Hex (mm)	Weight (g)
				L (mm)	A (mm)		
-	6	EA0079767	3	55	-	-	10
-	7	EA0079778	3	55	-	-	13
-	8	EA0079789	3	55	-	-	14
-	9	EA0079790	3	55	-	-	16
-	10	EA0079701	3	55	-	-	19
-	12	EA0079712	3	55	-	-	24
-	16	EA0079716	3	78	-	-	50
-	19	EA0079719	3	88	-	-	81

FLUID TRANSFER
AND HYDRAULIC

PNEUMATIC

SPECIAL APPLICATIONS

DIAGNOSTIC

AGRICULTURE

REFRIGERANT

Hose Reels



Eaton offers air hose reels and coil assemblies for pneumatic applications.

Product Features

SPUBD Series

- Tube material: Polyurethane
- Swivel connections: Nickel-plated brass

ENR Series

- Guard material: Steel
- Polyurethane braided hose

- Plug material: Brass
- Swivel joint material: Steel

Physical Characteristics

Series	Connection	Max. Operating Pressure		Temperature Range	
		(bar)	(psi)	C	F
SPUBD	G ¼ x G ¼	9	130.5	+50C/-40C	+122F/-40F
ENR	R ¼	15	220	+60C/-5C	+140F/+23F

Applications & Markets

- Pneumatic
- Manufacturing and Assembly

Series	Part Number	Connection	Hose I.D./O.D.	Max. Length	Min. Length	Coil Diameter	Color
			(mm)	(m)	(cm)	(mm)	
SPUBD	SPUBD0584E	G ¼ x G ¼	5 x 8	4	25	60	Blue
SPUBD	SPUBD65104E	G ¼ x G ¼	6.5 x 10	4	32	70	Blue

Series	Part Number	End Connection	Hose I.D./O.D.	L1	L2	H	I1	I2	Hose Length	Weight
			(mm)	(mm)	(mm)	(mm)	(mm)	(mm)	(m)	(g)
ENR	ENRTPU081210E	R ¼	8 x 12	345	380	320	121	170	10	9.5

FD17 Series



The Eaton FD17 high pressure coupling can be connected by hand while under pressure up to 5,500 psi/380 bar. This quick disconnect coupling is most commonly used in SCBA transfilling and buddy-breathing applications and is commonly found on SCBA equipment certified to various NIOSH, NFPA and CBRN standards.

Product Features

- Connect and disconnect under pressure up to 5,500 psi/380 bar
- Certified on SCBA equipment that meets NIOSH, NFPA and CBRN requirements
- Complies with NFPA 1981 and NFPA 2013
- Standard body material: Stainless steel, aluminum

Physical Characteristics

Series	Max. Operating Pressure		Min. Burst Pressure		Rated Flow*		Rated Temperature
	(bar)	(psi)	(bar)	(psi)	(lpm)	scfm	
FD17	380	5,500	1140	16,500	125	4.4	-40°F (-40°C)/+160°F (+71°C)

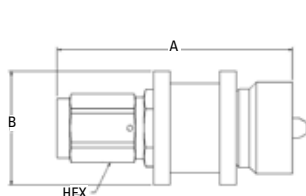

Figure 1

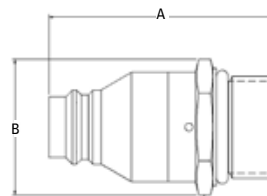

Figure 2

Part Number	Coupling Type	Body Size	Port Size	Thread	Type	Fig.	Dimensions					
							A (in)	B (in)	Hex (in)	A (mm)	B (mm)	Hex (mm)
FD17-1003-04-04	Socket/Female	¼	-4	7/16-20	ORB	1	2.85	1.38	0.75	72.4	35.1	19.1
FD17-1082-10-04	Plug/Male	¼	-10	7/8-14	ORB	2	1.93	1.43	1	49.0	36.3	25.4



Male Dust Cap

Part Number

FD17-1064-04*



Female Dust Cap

Part Number

FD17-1062-04

* Indicates patented product

FLUID TRANSFER AND HYDRAULIC

PNEUMATIC

SPECIAL APPLICATIONS

DIAGNOSTIC

AGRICULTURE

REFRIGERANT

FD69 Series 10,000 psi Water Blast



Eaton's FD69 Series design has a greater surface contact area for long service life in rugged high pressure and water blast applications. The maximum operating pressure is 10,000 psi with 40,000 psi minimum burst pressure.

Product Features

- Safety sleeve lock guards against accidental disconnection
- Smooth bore "straight through" design for high flow fluid requirements
- Heavy duty back-up ring to prevent O-Ring extrusion
- Available in plated steel and stainless steel for added corrosion resistance
- Standard seal material: Buna-N
- Standard body material: High resistance carbon steel with Zinc trivalent plating or stainless steel

Physical Characteristics

Coupling Size (in)	Max. Operating Pressure		Min. Burst Pressure Connected		Vacuum Connected Only	Rated Flow		Air Inclusion	Fluid Loss
	(bar)	(psi)	(bar)	(psi)	(in./Hg)	(lpm)	(gpm)	cc. max.	cc.max.
1/2	689	10,000	2,758	40,000	28	170	45	-	-

Applications & Markets

- High pressure WaterBlast
- Bridge/Concrete Repair
- Paint Stripping
- Shipyards

Flow Data

Pressure Drop Versus Flow Graph

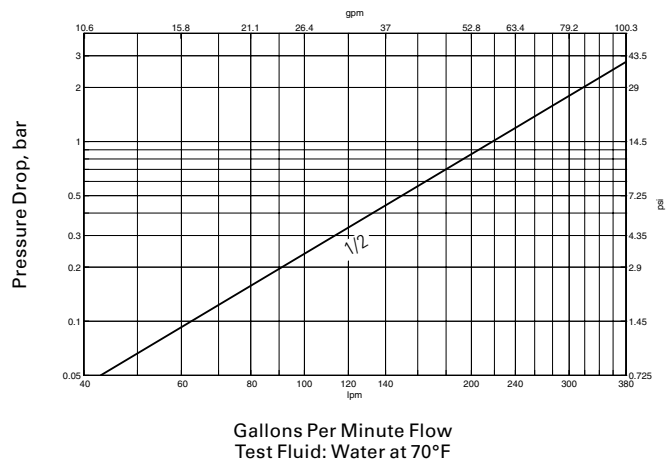

FD69 Series 10,000 psi Water Blast

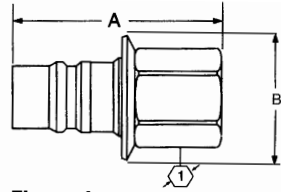

Figure 1

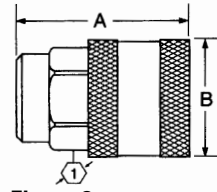

Figure 2

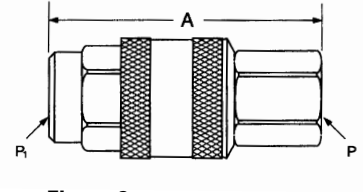

Figure 3

Dimensions (Female NPT)

Part Number	Buna-N	FKM	EPDM	Coupling Type	Body Size	Port Size	Thread	Type	Fig.	Dimensions		Hex ①			
										A	B				
										mm	(in)	mm	(in)	mm	(in)
Steel															
FD69-1002-06-08	FD69-1002-06-08	FD69-1002-06-08	FD69-1002-06-08	Plug/Male*	1/2	3/8	3/8-18	Female NPT	1	47.0	(1.85)	41.7	(1.64)	25.4	(1.00)
FD69-1001-06-08	FD69-1026-06-08	FD69-1028-06-08	FD69-1028-06-08	Socket/Female	1/2	3/8	3/8-18	Female NPT	2	54.1	(2.13)	41.1	(1.62)	31.8	(1.25)
FD69-1002-08-08	FD69-1002-08-08	FD69-1002-08-08	FD69-1002-08-08	Plug/Male*	1/2	1/2	1/2-14	Female NPT	1	59.4	(2.34)	41.7	(1.64)	28.4	(1.12)
FD69-1001-08-08	FD69-1026-08-08	FD69-1028-08-08	FD69-1028-08-08	Socket/Female	1/2	1/2	1/2-14	Female NPT	2	54.1	(2.13)	41.1	(1.62)	31.8	(1.25)
Stainless Steel															
FD69-1012-08-08	FD69-1012-08-08	FD69-1012-08-08	FD69-1012-08-08	Plug/Male*	1/2	1/2	1/2-14	Female NPT	1	59.4	(2.34)	41.7	(1.64)	28.4	(1.12)
FD69-1011-08-08	-	-	-	Socket/Female	1/2	1/2	1/2-14	Female NPT	2	54.1	(2.13)	41.1	(1.62)	33.3	(1.31)

*Male halves contain no seals.

Part Number	Buna-N	FKM	EPDM	Coupling Type	Body Size	Port Size	Thread (P) (P1)		Type	Fig.	Dimensions	
										A		
										mm	(in)	
Steel												
FD69-1000-080808	FD69-1027-080808	FD69-1029-080808	FD69-1029-080808	Complete	1/2	1/2	1/2-14	1/2-14	Female NPT	3	87.1	(3.43)
FD69-1000-080806	FD69-1027-080806	FD69-1029-080806	FD69-1029-080806	Complete	1/2	1/2 & 3/8	1/2-14	3/8-18	Female NPT	3	87.1	(3.43)
FD69-1000-060808	FD69-1027-060808	FD69-1029-060808	FD69-1029-060808	Complete	1/2	3/8 & 1/2	3/8-18	1/2-14	Female NPT	3	74.7	(2.94)
FD69-1000-060806	FD69-1027-060806	FD69-1029-060806	FD69-1029-060806	Complete	1/2	3/8	3/8-18	3/8-18	Female NPT	3	74.7	(2.94)
Stainless Steel												
FD69-1010-080808	-	-	-	Complete	1/2	1/2	1/2-14	1/2-14	Female NPT	3	87.1	(3.43)

Repair Kit, Female Interface Seal

Part Number	Coupling Size
Buna-N	
FF10166	1/2

FLUID TRANSFER
AND HYDRAULIC

PNEUMATIC

SPECIAL APPLICATIONS

DIAGNOSTIC

AGRICULTURE

REFRIGERANT

FD83 Series Full Flow Dual Interlock



Eaton's FD83 is designed for fluid transfer and electronics cooling applications where full flow, fluid compatibility and safety are essential. The FD83 identical halves include two interlock features to eliminate spills and ensure maximum safety. Valves cannot be opened until the coupling halves are mated and coupling halves cannot be disconnected until both halves are closed. The FD83 coupling system can be used in a wide variety of low pressure industrial applications.

Product Features

- Dual interlock safety feature eliminates accidental opening of coupling when disconnected with the use of a patented locking pin design and lever handle
- Design provides reliable performance and minimal spillage during maintenance or service
- Standard seal material: EPDM, additional material available on request
- Standard body material: 303 stainless steel, additional material available on request
- Full-flow capability
- Available color coded bumper seals available
- Identical coupling halves
- Maintenance and service friendly
- 303 stainless steel material provides broad fluid compatibility
- 3/4" and 1" Female NPT port threads or hose barb

Physical Characteristics

Coupling Size (in)	Max. Operating Pressure						Min. Burst Pressure								
	Connected		Socket/Female Half		Socket/Female Half		Connected		Socket/Female Half		Socket/Female Half		Rated Flow		Fluid Loss
	(bar)	(psi)	(bar)	(psi)	(bar)	(psi)	(bar)	(psi)	(bar)	(psi)	(bar)	(psi)	(lpm)	(gpm)	cc. max
1	10	150	10	150	10	150	20	300	20	300	20	300	189	50	5.0

Dimensions

Part Number	Body Size	Port Size	Thread	Type	Fig.	Dimensions				Hex	
						A		B		mm	(in)
FD83-2052-16-16	1	1	1-11- 1/2	Female NPT	1	95.5	(3.76)	71.6	(2.82)	41	(1.63)
FD83-2052-12-16	1	3/4	3/4-14	Female NPT	1	70.1	(2.76)	71.6	(2.83)	41	(1.63)
FD83-2046-16-16	1	1	NA	1" Hose Barb	2	84.2	(3.31)	71.6	(2.82)	-	-

Hose barb adapters available upon request.

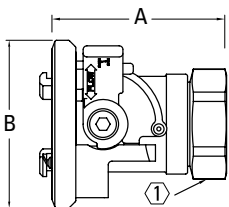

Figure 1

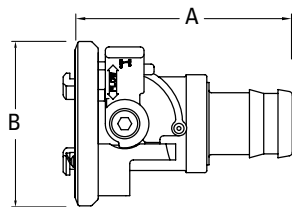
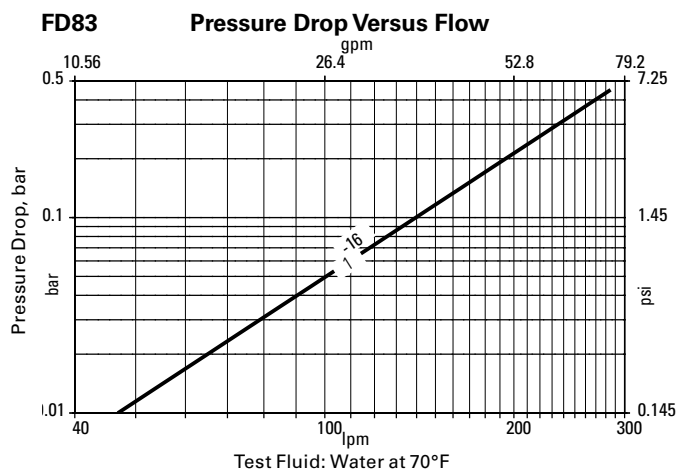

Figure 2

Applications & Markets

- Electronics Liquid Based Cooling
- Thermal Management Systems
- Industrial Fluid Transfer

Flow Data



2HKIG/2HKIL Series



Eaton's 2HKIG/2HKIL Series stainless steel couplings can be used with various liquids and gases. They are functionally identical, but do not interchange. They can be used where it is necessary to avoid crossing lines.

Product Features

- Ball lock
- Proprietary interchange with all stainless steel construction
- Female/Socket halves available with 90° connections
- Standard seal material: Buna-N
- Standard body material: Stainless steel

Physical Characteristics

Body Size (in)	Max. Operating Pressure Connected		Min. Burst Pressure		Rated Flow		All Inclusion	Fluid Loss
	(bar)	(psi)	(bar)	(psi)	(lpm)	(gpm)	cc. max.	cc. max.
1/4	103	1,500	412	6,000	8.3	2.2	2.2	1

Applications & Markets

- Chemical
- Food and Beverage
- Military
- Aerospace

Flow Data

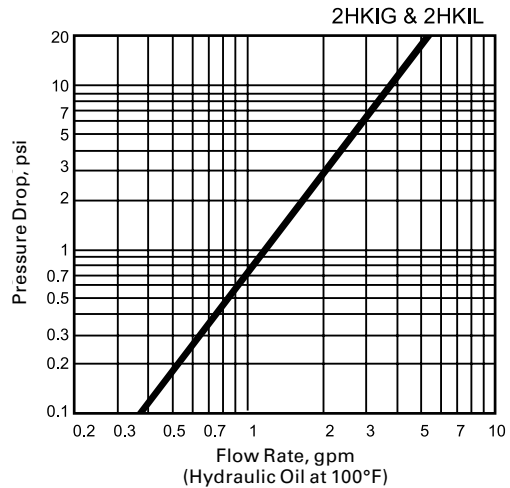

FLUID TRANSFER
AND HYDRAULIC

PNEUMATIC

SPECIAL APPLICATIONS

DIAGNOSTIC

AGRICULTURE

REFRIGERANT

2HKIG Series

FLUID TRANSFER
AND HYDRAULIC

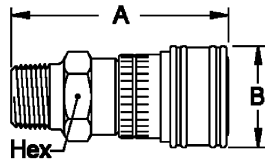

Figure 1

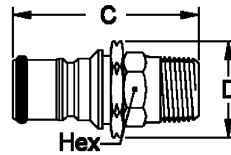

Figure 2

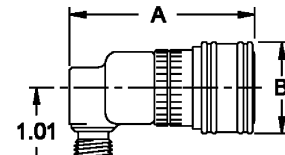

Figure 3

Male End Connections

Part Number	Coupling Type	Body Size	Thread	Fig.	Dimensions		Hex	A	B	Hex
					(in)	(in)				
2HIG10	Socket/Female	1/4	1/8-27 NPTF	1	2.18	1.06	0.81	55.4	26.9	20.6
2HIG15	Socket/Female	1/4	1/4-18 NPTF	1	2.31	1.06	0.81	58.7	26.9	20.6
2HIG20	Socket/Female	1/4	3/8-18 NPTF	1	2.31	1.06	0.81	58.7	26.9	20.6
2HIG720	Socket/Female	1/4	7/16-20 NPTF	1	2.27	1.06	0.81	57.7	26.9	20.6
2HIGLLRA720	Socket/Female	1/4	7/16-20 NPTF	3	2.09	1.06	—	53.1	26.9	—

Part Number	Coupling Type	Body Size	Thread	Fig.	Dimensions		Hex	C	D	Hex
					(in)	(in)				
2KIGF15	Plug/Male	1/4	1/4-18 NPTF	2	1.98	1.01	0.69	50.3	25.7	17.5
2KIGF20	Plug/Male	1/4	3/8-18 NPTF	2	1.98	1.01	0.69	50.3	25.7	17.5

PNEUMATIC

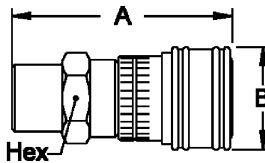

Figure 1

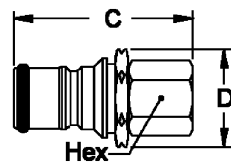

Figure 2

Female End Connections

Part Number	Coupling Type	Body Size	Thread	Fig.	Dimensions		Hex	A	B	Hex
					(in)	(in)				
2HIG11	Socket/Female	1/4	1/8-27 NPTF	1	2.18	1.06	0.81	55.4	26.9	20.6
2HIG16	Socket/Female	1/4	1/4-18 NPTF	1	2.26	1.06	0.81	57.4	26.9	20.6

Part Number	Coupling Type	Body Size	Thread	Fig.	Dimensions		Hex	C	D	Hex
					(in)	(in)				
2KIGF16	Plug/Male	1/4	1/4 -18 NPTF	2	1.84	1.01	0.69	46.7	25.7	17.5
2KIGF720	Plug/Male	1/4	7/16-20	2	1.61	1.01	0.69	40.9	25.7	17.5
2KIGF	Plug/Male	1/4	9/16-18	2	1.17	1.01	0.68	29.7	25.7	17.3

SPECIAL APPLICATIONS

DIAGNOSTIC

AGRICULTURE

REFRIGERANT

2HKIL Series

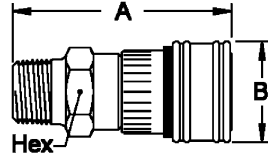

Figure 1

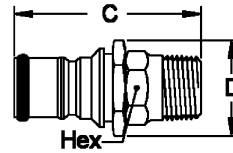

Figure 2

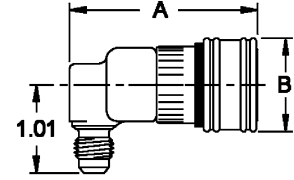

Figure 3

Male End Connections

Part Number	Coupling Type	Body Size	Thread	Fig.	Dimensions		Hex	A	B	Hex
					A	B				
					(in)	(in)	(in)	(mm)	(mm)	(mm)
2HIL10	Socket/Female	1/4	1/8-27 NPTF	1	2.18	1.06	0.81	55.4	26.9	20.6
2HIL15	Socket/Female	1/4	1/4-18 NPTF	1	2.31	1.06	0.81	58.7	26.9	20.6
2HIL20	Socket/Female	1/4	3/8-18 NPTF	1	2.31	1.06	0.81	58.7	26.9	20.6
2HIL720	Socket/Female	1/4	7/16-20 NPTF	1	2.27	1.06	0.81	57.7	26.9	20.6
2HILLRA720	Socket/Female	1/4	7/16-20 NPTF	3	2.09	1.06	—	53.1	26.9	—

Part Number	Coupling Type	Body Size	Thread	Fig.	Dimensions		Hex	C	D	Hex
					C	D				
					(in)	(in)	(in)	(mm)	(mm)	(mm)
2KILF15	Plug/Male	1/4	1/4-18 NPTF	2	1.98	1.01	0.69	50.3	25.7	17.5
2KILF20	Plug/Male	1/4	3/8-18 NPTF	2	1.98	1.01	0.69	50.3	25.7	17.5

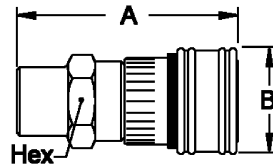

Figure 1

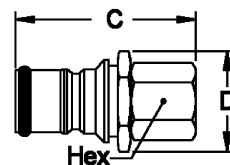

Figure 2

Female End Connections

Part Number	Coupling Type	Body Size	Thread	Fig.	Dimensions		Hex	A	B	Hex
					A	B				
					(in)	(in)	(in)	(mm)	(mm)	(mm)
2HIL11	Socket/Female	1/4	1/8-27 NPTF	1	2.18	1.06	0.81	55.4	26.9	20.6
2HIL16	Socket/Female	1/4	1/4-18 NPTF	1	2.26	1.06	0.81	57.4	26.9	20.6

Part Number	Coupling Type	Body Size	Thread	Fig.	Dimensions		Hex	C	D	Hex
					C	D				
					(in)	(in)	(in)	(mm)	(mm)	(mm)
2KILF16	Plug/Male	1/4	1/4-18 NPTF	2	1.84	1.01	0.69	46.7	25.7	17.5
2KILF720	Plug/Male	1/4	7/16-20	2	1.61	1.01	0.69	40.9	25.7	17.5
2KILF	Plug/Male	1/4	9/16-18	2	1.17	1.01	0.68	29.7	25.7	17.3

FLUID TRANSFER AND HYDRAULIC

PNEUMATIC

SPECIAL APPLICATIONS

DIAGNOSTIC

AGRICULTURE

REFRIGERANT

ST Series



Eaton's ST Series is a straight-through coupling that is designed for use where minimum pressure drop is required and valving is not needed. These couplings are suited for various and versatile fluid transfer type systems.

Product Features

- Ball-latching mechanism
- Smooth bore permits free flow of liquid or gas
- Available in NPTF, BSPP and Hose stem end connections
- Standard seal material: Buna-N
- Standard body material: Brass, 303 stainless steel, steel

European Pressure Equipment Directive

Couplings with nominal diameters up to and including 25 mm are designed and manufactured under Article 4.3 of the European Pressure Equipment Directive PED 2014/68/EU. Couplings with nominal diameters greater than 25 mm are designed and manufactured in accordance with the stipulations of Module A of the European Pressure Equipment Directive PED 2014/68/EU. They should not be used to convey unstable gases.

Physical Characteristics

Series	Body Size (in)	Max. Operating Pressure Brass Socket & Plug**		Max. Operating Pressure Brass Socket & Steel Plug**		Max. Operating Pressure Stainless Socket & Plug**		Max. Operating pressure for Hazardous liquids and gases Group 1		Min. Burst Pressure*		Rated Flow	
		(bar)	(psi)	(bar)	(psi)	(bar)	(psi)	(bar)	(psi)	(bar)	(psi)	(lpm)	(gpm)
1ST	1/8	193	2,800	234	3,400	290	4,200	***	***	772	11,200	10	2.7
2ST	1/4	359	5,200	379	5,500	517	7,500	***	***	1,436	20,800	21	5.6
3ST	3/8	193	2,800	290	4,200	434	6,300	***	***	772	11,200	57	15
4ST	1/2	152	2,200	241	3,500	248	3,600	***	***	608	8,800	83	22
6ST	3/4	117	1,700	145	2,100	207	3,000	***	***	468	6,800	250	66
8ST	1	90	1,300	138	2,000	138	2,000	***	***	360	5,200	530	140
10ST	1 1/4	117	1,700	186	2,700	152	2,200	***	***	468	6,800	697	184
12ST	1 1/2	97	1,400	152	2,200	172	2,500	33	480	388	5,600	1,124	297
16ST	2	97	1,400	152	2,200	103	1,500	27	390	388	5,600	1,855	490
20ST	2 1/2	62	900	103	1,500	—	—	20	290	248	3,600	3,131	827

* For Brass socket and plug. Other materials have 4 to 1 safety factor
 ** Operating pressure for Non Hazardous liquids and gases from Group 2
 *** Operating pressure is same as Non Hazardous liquids and gases from Group 2 for this size

Applications & Markets

- Fluid Transfer
- Chemical
- Food and Beverage
- Injection Molding
- Marine
- Medical
- Pressure Washing
- Steam Cleaning

Flow Data

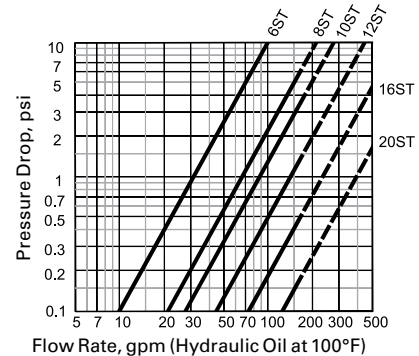
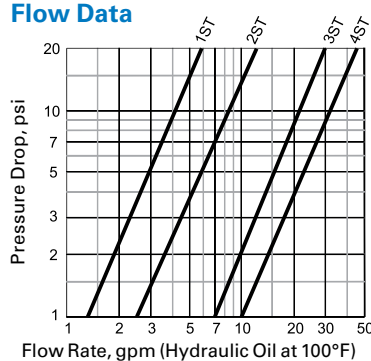

ST Series

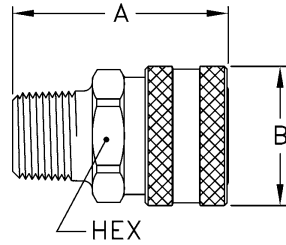

Figure 1

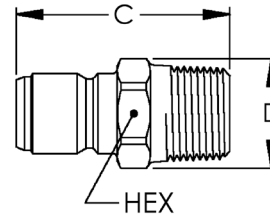

Figure 2

Male End Connections

Part Number	Brass	Steel	Stainless	Coupling Type	Body Size	Port Size	Thread	Type	Fig.	Dimensions						
										A	B	Hex	A	B	Hex	
											(in)	(in)	(in)	(mm)	(mm)	(mm)
1S10	—	LL1S10	Socket/Female	1/8	1/8	1/8-27	NPTF	1	1.06	0.72	0.56	26.9	18.3	14.2		
1S10BS	—	—	Socket/Female	1/8	1/8	1/8-28	BSPP	1	1.00	0.72	0.56	25.4	18.3	14.2		
2S15	—	LL2S15	Socket/Female	1/4	1/4	1/4-18	NPTF	1	1.72	0.97	0.81	43.7	24.6	20.6		
3S20	—	LL3S20	Socket/Female	3/8	3/8	3/8-18	NPTF	1	1.75	1.16	1.00	44.5	29.5	25.4		
3S20BS	—	LL3S20BS	Socket/Female	3/8	3/8	3/8-19	BSPP	1	1.71	1.16	1.00	43.4	29.5	25.4		
4S25	—	LL4S25	Socket/Female	1/2	1/2	1/2-14	NPTF	1	2.03	1.34	1.13	51.6	34.0	28.7		
4S25BS	—	LL4S25BS	Socket/Female	1/2	1/2	1/2-14	BSPP	1	1.80	1.34	1.13	45.7	34.0	28.7		
6S30	—	LL6S30	Socket/Female	3/4	3/4	3/4-14	NPTF	1	2.22	1.72	1.44	56.4	43.7	36.6		
6S30BS	—	—	Socket/Female	3/4	3/4	3/4-14	BSPP	1	2.03	1.72	1.44	51.6	43.7	36.6		
8S35	—	—	Socket/Female	1	1	1-11 1/2	NPTF	1	2.53	2.03	1.75	64.3	51.6	44.5		
8S35BS	—	—	Socket/Female	1	1	1-11	BSPP	1	2.37	2.03	1.75	60.2	51.6	44.5		
Part Number	Brass	Steel	Stainless	Coupling Type	Body Size	Port Size	Thread	Type	Fig.	Dimensions						
										C	D	Hex	C	D	Hex	
											(in)	(in)	(in)	(mm)	(mm)	(mm)
B1T10	1T10E	LL1T10	Plug/Male	1/8	1/8	1/8-27	NPTF	2	1.06	0.51	0.44	26.9	13.0	11.2		
B1T15	1T15	—	Plug/Male	8	1/4	1/4-18	NPTF	2	1.22	0.65	0.56	31.0	16.5	14.2		
B2T15	2T15	LL2T15	Plug/Male	1/4	1/4	1/4-18	NPTF	2	1.56	0.65	0.56	39.6	16.5	14.2		
—	—	HL2T15**	Plug/Male	1/4	1/4	1/4-18	NPTF	2	1.56	0.65	0.56	39.6	16.5	14.2		
B2T15BS	—	LL2T15BS	Plug/Male	1/4	1/4	1/4-19	BSPP	2	1.46	0.87	0.75	37.1	22.1	19.1		
B3T20	3T20	LL3T20	Plug/Male	3/8	3/8	3/8-18	NPTF	2	1.69	0.79	0.69	42.9	20.1	17.5		
—	—	HL3T20**	Plug/Male	3/8	3/8	3/8-18	NPTF	2	1.69	0.79	0.69	42.9	20.1	17.5		
B3T20BS	—	LL3T20BS	Plug/Male	3/8	3/8	3/8-19	BSPP	2	1.50	1.01	0.88	38.1	25.7	22.4		
B4T25	4T25	LL4T25	Plug/Male	1/2	1/2	1/2-14	NPTF	2	2.01	1.01	0.88	51.1	25.7	22.4		
B4T25BS	—	LL4T25BS	Plug/Male	1/2	1/2	1/2-14	BSPP	2	1.82	1.15	1.00	46.2	29.2	25.4		
B6T30	6T30	LL6T30	Plug/Male	3/4	3/4	3/4-14	NPTF	2	2.2	1.23	1.06	55.9	31.2	26.9		
B6T30BS	—	LL6T30BS	Plug/Male	3/4	3/4	3/4-14	BSPP	2	2.08	1.44	1.25	52.8	36.6	31.8		
B8T35	8T35	LL8T35	Plug/Male	1	1	1-11 1/2	NPTF	2	2.49	1.59	1.38	63.2	40.4	35.1		
B8T35BS	—	—	Plug/Male	1	1	1-11	BSPP	2	2.36	2.02	1.75	59.9	51.3	44.5		
B10T40	10T40	LL10T40	Plug/Male	1 1/4	1 1/4	1 1/4-11 1/2	NPTF	2	2.72	2.02	1.75	69.1	51.3	44.5		
B10T40BS	—	—	Plug/Male	1 1/4	1 1/4	1 1/4-11	BSPP	2	2.55	2.31	2.00	64.8	58.7	50.8		
B12T45	12T45	—	Plug/Male	1 1/2	1 1/2	1 1/2-11 1/2	NPTF	2	3.31	2.6	2.25	84.1	66.0	57.2		
B12T45BS	—	—	Plug/Male	1 1/2	1 1/2	1 1/2-11	BSPP	2	3.06	2.6	2.25	77.7	66.0	57.2		
B16T50	16T50	LL16T50	Plug/Male	2	2	2-11 1/2	NPTF	2	3.5	3.18	2.75	88.9	80.8	69.9		
B20T55	—	—	Plug/Male	2 1/2	2 1/2	2 1/2-8	NPTF	2	4.24	3.75	3.25	107.7	95.3	82.6		

**High impulse heat treated 416 stainless steel

FLUID TRANSFER
AND HYDRAULIC

PNEUMATIC

SPECIAL APPLICATIONS

DIAGNOSTIC

AGRICULTURE

REFRIGERANT

ST Series

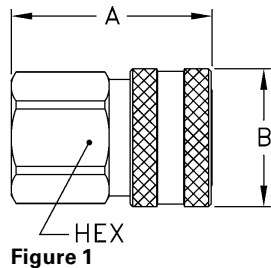

Figure 1

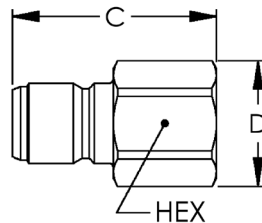

Figure 2

Female End Connections

Part Number	Brass	Steel	Stainless	Coupling Type	Body Size	Port Size	Thread	Type	Fig.	Dimensions						
										A	B	Hex	A	B	Hex	
											(in)	(in)	(in)	(mm)	(mm)	(mm)
1S11	—	—	LL1S11	Socket/Female	1/8	1/8	1/8-27	NPTF	1	1.06	0.72	0.56	26.9	18.3	14.2	
1S11BS	—	—	LL1S11BS	Socket/Female	1/8	1/8	1/8-28	BSPP	1	1.03	0.72	0.56	26.2	18.3	14.2	
2S16	—	—	LL2S16	Socket/Female	1/4	1/4	1/4-18	NPTF	1	1.5	0.97	0.81	38.1	24.6	20.6	
2S16BS	—	—	LL2S16BS	Socket/Female	1/4	1/4	1/4-19	BSPP	1	1.5	0.97	0.81	38.1	24.6	20.6	
3S21	—	—	LL3S21	Socket/Female	3/8	3/8	3/8-18	NPTF	1	1.59	1.16	1.00	40.4	29.5	25.4	
3S21BS	—	—	LL3S21BS	Socket/Female	3/8	3/8	3/8-19	BSPP	1	1.59	1.16	1.00	40.4	29.5	25.4	
4S26	—	—	LL4S26	Socket/Female	1/2	1/2	1/2-14	NPTF	1	1.91	1.34	1.13	48.5	34.0	28.7	
4S26BS	—	—	LL4S26BS	Socket/Female	1/2	1/2	1/2-14	BSPP	1	1.91	1.34	1.13	48.5	34.0	28.7	
6S31	—	—	LL6S31	Socket/Female	3/4	3/4	3/4-14	NPTF	1	2.06	1.72	1.44	52.3	43.7	36.6	
6S31BS	—	—	LL6S31BS	Socket/Female	3/4	3/4	3/4-14	BSPP	1	2.06	1.72	1.44	52.3	43.7	36.6	
8S36	—	—	LL8S36	Socket/Female	1	1	1-11 1/2	NPTF	1	2.33	2.03	1.75	59.2	51.6	44.5	
8S36BS	—	—	LL8S36BS	Socket/Female	1	1	1-11	BSPP	1	2.33	2.03	1.75	59.2	51.6	44.5	
10S41*	—	—	LL10S41	Socket/Female	1 1/4	1 1/4	1 1/4-11 1/2	NPTF	1	2.44	2.5	2.00	62.0	63.5	50.8	
10S41BS*	—	—	—	Socket/Female	1 1/4	1 1/4	1 1/4-11	BSPP	1	2.51	2.5	2.00	63.8	63.5	50.8	
12S46*	—	—	LL12S46	Socket/Female	1 1/2	1 1/2	1 1/2-11 1/2	NPTF	1	2.88	3.13	2.60	73.2	79.5	66.0	
12S46BS*	—	—	LL12S46BS	Socket/Female	1 1/2	1 1/2	1 1/2-11	BSPP	1	2.88	3.13	2.63	73.2	79.5	66.8	
16S51*	—	—	LL16S51	Socket/Female	2	2	2-11 1/2	NPTF	1	3.09	3.75	3.00	78.5	95.3	76.2	
16S51BS*	—	—	LL16S51BS	Socket/Female	2	2	2-11	BSPP	1	3.3	3.75	3.00	83.8	95.3	76.2	
20S56*	—	—	—	Socket/Female	2 1/2	2 1/2	2 1/2-8	NPTF	1	3.44	4.5	3.50	87.4	114.3	88.9	

Part Number	Brass	Steel	Stainless	Coupling Type	Body Size	Port Size	Thread	Type	Fig.	Dimensions						
										C	D	Hex	C	D	Hex	
											(in)	(in)	(in)	(mm)	(mm)	(mm)
B1T11	—	1T11	LL1T11	Plug/Male	1/8	1/8	1/8-27	NPTF	2	0.97	0.58	0.50	24.6	14.7	12.7	
B1T11BS	—	—	LL1T11BS	Plug/Male	1/8	1/8	1/8-28	BSPP	2	0.97	0.65	0.56	24.6	16.5	14.2	
B2T16	—	2T16	LL2T16	Plug/Male	1/4	1/4	1/4-18	NPTF	2	1.45	0.79	0.69	36.8	20.1	17.5	
—	—	—	HL2T16**	Plug/Male	1/4	1/4	1/4-18	NPTF	2	1.45	0.79	0.69	36.8	20.1	17.5	
B2T16BS	—	—	LL2T16BS	Plug/Male	1/4	1/4	1/4-19	BSPP	2	1.45	0.87	0.75	36.8	22.1	19.1	
B3T21	—	3T21	LL3T21	Plug/Male	3/8	3/8	3/8-18	NPTF	2	1.63	0.94	0.81	41.4	23.9	20.6	
—	—	—	HL3T21**	Plug/Male	3/8	3/8	3/8-18	NPTF	2	1.63	0.94	0.81	41.4	23.9	20.6	
B3T21BS	—	—	LL3T21BS	Plug/Male	3/8	3/8	3/8-19	BSPP	2	1.63	1.01	0.88	41.4	25.7	22.4	
B4T26	—	4T26	LL4T26	Plug/Male	1/2	1/2	1/2-14	NPTF	2	1.92	1.15	1.00	48.8	29.2	25.4	
B4T26BS	—	—	LL4T26BS	Plug/Male	1/2	1/2	1/2-14	BSPP	2	1.92	1.23	1.06	48.8	31.2	26.9	
B6T31	—	6T31	LL6T31	Plug/Male	3/4	3/4	3/4-14	NPTF	2	2.01	1.37	1.19	51.1	34.8	30.2	
B6T31BS	—	—	LL6T31BS	Plug/Male	3/4	3/4	3/4-14	BSPP	2	2.01	1.51	1.31	51.1	38.4	33.3	
B8T36	—	8T36	LL8T36	Plug/Male	1	1	1-11 1/2	NPTF	2	2.21	1.8	1.56	56.1	45.7	39.6	
B8T36BS	—	—	LL8T36BS	Plug/Male	1	1	1-11	BSPP	2	2.23	1.8	1.56	56.6	45.7	39.6	
B10T41	—	10T41	LL10T41	Plug/Male	1 1/4	1 1/4	1 1/4-11 1/2	NPTF	2	2.34	2.31	2.00	59.4	58.7	50.8	
B10T41BS	—	—	LL10T41BS	Plug/Male	1 1/4	1 1/4	1 1/4-11	BSPP	2	2.53	2.31	2.00	64.3	58.7	50.8	
B12T46	—	12T46	LL12T46	Plug/Male	1 1/2	1 1/2	1 1/2-11 1/2	NPTF	2	2.88	2.6	2.25	73.2	66.0	57.2	
B12T46BS	—	—	LL12T46BS	Plug/Male	1 1/2	1 1/2	1 1/2-11	BSPP	2	2.88	2.6	2.25	73.2	66.0	57.2	
B16T51	—	16T51	—	Plug/Male	2	2	2-11 1/2	NPTF	2	3.03	3.18	2.75	77.0	80.8	69.9	
B16T51BS	—	—	—	Plug/Male	2	2	2-11	BSPP	2	3.25	3.18	2.75	82.6	80.8	69.9	
B20T56	—	20T56	—	Plug/Male	2 1/2	2 1/2	2 1/2-8	NPTF	2	3.37	3.75	3.25	85.6	95.3	82.6	

*With Steel Sleeve

** High impulse heat treated 416 stainless steel

ST Series

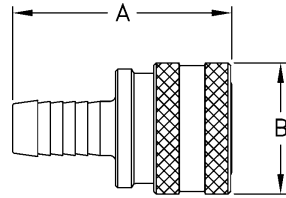

Figure 1

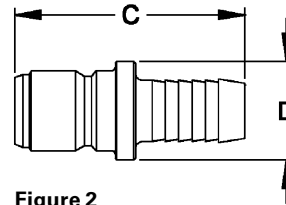

Figure 2

Hose Stem End Connections

Part Number	Brass	Stainless	Steel	Coupling Type	Body Size	Hose I.D.	Fig.	Dimensions			
								A	B	A	B
								(in)	(in)	(mm)	(mm)
1S12		LL1S12	—	Socket/Female	1/8	3/16	1	1.41	0.72	35.8	18.3
1S17		LL1S17	—	Socket/Female	1/8	1/4	1	1.41	0.72	35.8	18.3
2S17		LL2S17	—	Socket/Female	1/4	1/4	1	2.10	0.97	53.3	24.6
3S22		LL3S22	—	Socket/Female	3/8	3/8	1	2.09	1.16	53.1	29.5
4S27		LL4S27	—	Socket/Female	1/2	1/2	1	2.19	1.34	55.6	34.0
6S32		LL6S32	—	Socket/Female	3/4	3/4	1	3.19	1.72	81.0	43.7
8S37		LL8S37	—	Socket/Female	1	1	1	3.32	2.03	84.3	51.6

Part Number	Brass	Stainless	Steel	Coupling Type	Body Size	Hose I.D.	Fig.	Dimensions			
								C	D	C	D
								(in)	(in)	(mm)	(mm)
B1T12		LL1T12	—	Plug/Male	1/8	3/16	2	1.28	0.44	32.5	11.2
B1T17		LL1T17	—	Plug/Male	1/8	1/4	2	1.28	0.44	32.5	11.2
B2T17		LL2T17	—	Plug/Male	1/4	1/4	2	1.93	0.56	49.0	14.2
B3T22		LL3T22	—	Plug/Male	3/8	3/8	2	2.09	0.69	53.1	17.5
B4T27		LL4T27	—	Plug/Male	1/2	1/2	2	2.17	0.88	55.1	22.4
B6T32		LL6T32	—	Plug/Male	3/4	3/4	2	3.17	1.19	80.5	30.2
B8T37		—	8T37	Plug/Male	1	1	2	3.28	1.5	83.3	38.1

Dust Caps and Dust Plugs

Series	Dust Cap	Dust Plug
2ST	—	PSDC1HK
3ST	—	PSDC2HK
6ST	PPDC4HK	PSDC4HK
8ST	PPDC6HK	—
10ST	PPDC8HK	—



Vinyl Dust Plug

Vinyl Dust Cap

FLUID TRANSFER
AND HYDRAULIC

PNEUMATIC

SPECIAL APPLICATIONS

DIAGNOSTIC

AGRICULTURE

REFRIGERANT

L7000 Series Full Flow (Steel)



Eaton's L7000 Series steel quick disconnect coupling is a full-flow coupling with a rugged construction. Similar to the Eaton H5000 Series, the heat treatment and hardened materials give the coupling excellent resistance to mechanical and hydraulic demands. It is suited for applications where maximum flow capacity is a requirement and valving is not needed.

Product Features

- Proprietary profile
- Full flow pull-to-connect couplings
- Ball-locking
- Excellent flow performance
- Standard body material: Zinc trivalent plated steel
- Optional dust caps and plugs (made of anodized aluminum)
- Standard seal material: NBR, FKM, EPDM

European Pressure Equipment Directive*

Couplings with nominal diameters up to and including 25 mm are designed and manufactured under Article 4.3 of the European Pressure Equipment Directive PED 2014/68/EU. Couplings with nominal diameters greater than 25 mm are designed and manufactured in accordance with the stipulations of Module A of the European Pressure Equipment Directive PED 2014/68/EU. They should not be used to convey unstable gases.

*Group 1 = Hazardous media / Group 2 = Other media

Physical Characteristics

Body Size (in)	Nominal Flow Diameter (mm)	Max. Operating Pressure (connected)*			
		Non hazardous liquids & gases in Group 2		Hazardous liquids & gases in Group 1	
		bar	(psi)	bar	(psi)
1/8	8	1,000	14,500	1,000	14,500
1/4	10	700	10,150	700	10,150
3/8	12	600	8,700	600	8,700
1/2	15	500	7,250	500	7,250
3/4	20	400	5,800	400	5,800
1	25	300	4,350	300	4,350
1 1/4	33	200	2,900	30	435
1 1/2	40	150	2,175	24	345
2	50	100	1,450	19	275

Applications & Markets

- Fluid Transfer Lines
- Refrigerant Circuits
- Applications where maximum flow capacity is required

Flow Data

The nominal flow diameter of the coupling has no impact on pressure drop, as it is wider than the circuit diameter.

Seal Elastomer Data*

Seal Elastomer	Max. Operation Temperature Range
NBR (Nitrile)	-20°C +100°C/-4°F +212°F
FKM (Fluorocarbon)	-20°C +200°C/-4°F +392°F
EPDM (Ethylene-Propylene)**	-40°C +150°C/-40°F +302°F

*For reference only, based on Eaton recommended temperatures.

**In accordance with NF L 17-241 or NAS 1613 rev. 5, depending on size.

Contact Eaton technical support for further information on fluid compatibility.

L7000 Series Full Flow (Steel)

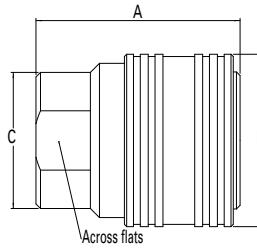

Figure 1

Sockets (Female)

Part Number			Body Size (in)	Nominal Flow Diameter (mm)	Thread Size** (Female) BSPP	Fig.	Dimensions								Weight	
NBR*	FKM	EPDM					A (in)	B (in)	C (in)	Across flats (in)	A (mm)	B (mm)	C (mm)	Across flats (mm)	lbs	grams
LA0700100	LA07001V0	LA07001E0	1/8	8	1/8-28	1	1.63	0.94	0.83	0.63	41.5	24	21	16	0.19	86
LA0701100	LA07011V0	LA07011E0	1/4	10	1/4-19	1	1.42	1.10	0.83	0.75	36	28	21	19	0.19	87
LA0702100	LA07021V0	LA07021E0	3/8	12	3/8-19	1	1.50	1.34	1.02	0.90	38	34	26	23	0.28	129
LA0703100	LA07031V0	LA07031E0	1/2	15	1/2-14	1	1.77	1.50	1.18	1.06	45	38	30	27	0.39	177
LA0704100	LA07041V0	LA07041E0	3/4	20	3/4-14	1	2.20	1.89	1.50	1.38	56	48	38	35	0.78	355
LA0705100	LA07051V0	LA07051E0	1	25	1-11	1	2.40	2.05	1.77	1.61	61	52	45	41	0.97	440
-	LA07061V0	LA07061E0	1 1/4	33	1 1/4-11	1	2.64	2.95	2.36	2.16	67	75	60	55	2.15	975
-	LA07071V0	LA07071E0	1 1/2	40	1 1/2-11	1	3.38	3.35	2.83	2.56	86	85	72	65	3.85	1745
-	LA07091V0	LA07091E0	2	50	2-11	1	3.46	3.82	3.27	2.95	88	97	83	75	4.11	1865

*Body sizes 1 1/4, 1 1/2 and 2 are supplied with FKM seals as a standard.

**Alternative end connections available upon request.

To obtain connected length of coupling add dimensions A (Fig. 1) and G (Fig. 2) together

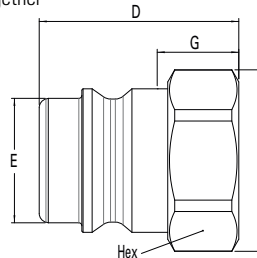

Figure 2

Plugs (Male)

Part Number	Body Size (in)	Nominal Flow Diameter (mm)	Thread Size* (Female) BSPP	Fig.	Dimensions								Weight			
					D (in)	E (in)	F (in)	G (in)	Hex (in)	D (mm)	E (mm)	F (mm)	G (mm)	Hex (mm)	lbs	grams
LA0700200	1/8	8	1/8-28	2	1.02	0.43	0.72	0.41	0.63	26	11	18.4	10.5	16	0.04	19
LA0701200	1/4	10	1/4-19	2	1.00	0.56	0.82	0.41	0.75	25.5	14.2	21	10.5	19	0.06	26
LA0702200	3/8	12	3/8-19	2	1.10	0.75	1.02	0.42	0.90	28	19	26	10.7	23	0.10	45
LA0703200	1/2	15	1/2-14	2	1.30	0.81	1.18	0.51	1.06	33	20.6	30	13	27	0.12	54
LA0704200	3/4	20	3/4-14	2	1.57	1.10	1.50	0.55	1.38	40	27.9	38	14	35	0.26	117
LA0705200	1	25	1-11	2	1.73	1.27	1.77	0.73	1.61	44	32.4	45	18.5	41	0.34	155
LA0706200	1 1/4	33	1 1/4-11	2	2.12	1.73	2.36	0.83	2.16	54	44	60	21	55	0.94	424
LA0707200	1 1/2	40	1 1/2-11	2	2.32	2.10	2.83	0.87	2.56	59	53.5	71.9	22	65	1.45	656
LA0709200	2	50	2-11	2	2.68	2.47	3.27	1.06	2.95	68	62.8	83	27	75	1.85	839

*Alternative end connections available upon request.

To obtain connected length of coupling add dimensions A (Fig. 1) and G (Fig. 2) together.

L7000 Series Full Flow (Steel)

FLUID TRANSFER
AND HYDRAULIC

Dust Plugs and Dust Caps

Body Size	Socket Dust Plug Part Number	Plug Dust Cap Part Number
(in)	Anodized Aluminum	Anodized Aluminum
1/8	HD0510100	HD0510200
1/4	HD0511100	HD0511200
3/8	HD0512100	HD0512200
1/2	HD0513100	HD0513200
3/4	HD0514100	HD0514200
1	HD0515100	HD0515200
1 1/4	HD0516100	HD0516200
1 1/2	HD0517100	HD0517200
2	HD0519100	HD0519200

Socket Dust Plug



Plug Dust Cap

PNEUMATIC

Seal Kit for Servicing Sockets (Female)

Body Size	Seal & Back-up Ring Kit*					
	(in)	NBR seals & PTFE back-up rings	Qty	FKM seals & PTFE back-up rings	Qty	EPDM seals & PTFE back-up rings
1/8	HG 05001 00	50 O-rings + 50 Backup rings	HG 05001 V0	15 O-rings + 15 Backup rings	HG 05001 E0	15 O-rings + 15 Backup rings
1/4	HG 05011 00	50 O-rings + 50 Backup rings	HG 05011 V0	15 O-rings + 15 Backup rings	HG 05011 E0	15 O-rings + 15 Backup rings
3/8	HG 05021 00	50 O-rings + 50 Backup rings	HG 05021 V0	15 O-rings + 15 Backup rings	HG 05021 E0	15 O-rings + 15 Backup rings
1/2	HG 05031 00	50 O-rings + 50 Backup rings	HG 05031 V0	15 O-rings + 15 Backup rings	HG 05031 E0	15 O-rings + 15 Backup rings
3/4	HG 05041 00	50 O-rings + 50 Backup rings	HG 05041 V0	15 O-rings + 15 Backup rings	HG 05041 E0	15 O-rings + 15 Backup rings
1	HG 05051 00	50 O-rings + 50 Backup rings	HG 05051 V0	10 O-rings + 10 Backup rings	HG 05051 E0	10 O-rings + 10 Backup rings
1 1/4	LG 07061 00	15 O-rings + 15 Backup rings	HG 05061 V0	5 O-rings + 5 Backup rings	-	-
1 1/2	LG 07071 00	15 O-rings + 15 Backup rings	-	-	-	-
2	LG 07091 00	15 O-rings + 15 Backup rings	-	-	-	-

*The valve seal is not included in our repair kits

SPECIAL APPLICATIONS

DIAGNOSTIC

AGRICULTURE

REFRIGERANT

L7000 Series Full Flow (Brass)



Eaton's L7000 Series brass quick disconnect coupling is a full-flow coupling suited for applications where maximum flow capacity is required and valving is not needed. Mainly used in fluid transfer applications where stainless steel is not a requirement, it can vehicle a wide range of media and offers good corrosion resistance.

Product Features

- Proprietary profile
- Full flow pull-to-connect couplings
- Ball-locking
- Excellent flow performance
- Standard body material: Nickel-plated brass
- Optional dust caps and plugs (made of anodized aluminum)
- Standard seal material: NBR, FKM, EPDM

European Pressure Equipment Directive*

All couplings are designed and manufactured under Article 4.3 of the European Pressure Equipment Directive PED 2014/68/EU. Couplings with nominal diameters greater than 25 mm should not be used to convey gases in Group 1 (hazardous).

* Group 1 = Hazardous media / Group 2 = Other media

Applications & Markets

- Pressure Washing
- Steam-Cleaning Equipment
- Fluid Transfer Lines
- Refrigerant Circuits
- Applications where maximum flow capacity is required

Physical Characteristics

Body Size	Nominal Flow Diameter	Max. Operating Pressure (connected)*			
		Liquids in Groups 1 and 2		Gases in Group 2	
(in)	(mm)	bar	(psi)	bar	(psi)
1/8	8	300	4,350	300	4,350
1/4	10	230	3,335	230	3,335
3/8	12	175	2,535	175	2,535
1/2	15	150	2,175	150	2,175
3/4	20	125	1,810	125	1,810
1	25	100	1,450	100	1,450
1 1/4	33	60	870	30	435
1 1/2	40	49	710	24	348
2	50	39	565	19	275

*Nominal diameters over 25 mm should not be used to convey gases in Group 1 (as per PED 2014/68/EU).

Flow Data

The nominal flow diameter of the coupling has no impact on pressure drop, as it is wider than the circuit diameter.

Seal Elastomer Data*

Seal Elastomer	Max. Operation Temperature Range
NBR (Nitrile)	-20°C +100°C/-4°F +212°F
FKM (Fluorocarbon)	-20°C +200°C/-4°F +392°F
EPDM (Ethylene-Propylene)**	-40°C +150°C/-40°F +302°F

*For reference only, based on Eaton recommended temperatures.

**In accordance with NF L 17-241 or NAS 1613 rev. 5, depending on size.

Contact Eaton technical support for further information on fluid compatibility.

L7000 Series Full Flow (Brass)

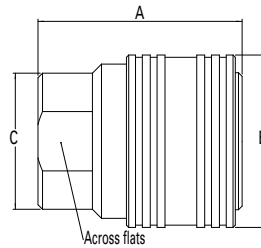

Figure 1

Sockets (Female)

Part Number	FKM	EPDM	Body Size (in)	Nominal Flow Diameter (mm)	Thread Size** (Female)	BSP	Dimensions								Weight	
							Fig.	A (in)	B (in)	C (in)	Across flats (in)	A (mm)	B (mm)	C (mm)	Across flats (mm)	lbs
LL0700100	LL07001V0	LL07001E0	1/8	8	1/8-28	1	1.63	0.94	0.83	0.63	41.5	24	21	16	0.21	95
LL0701100	LL07011V0	LL07011E0	1/4	10	1/4-19	1	1.42	1.10	0.83	0.75	36	28	21	19	0.21	96
LL0702100	LL07021V0	LL07021E0	3/8	12	3/8-19	1	1.50	1.34	1.02	0.90	38	34	26	23	0.31	142
LL0703100	LL07031V0	LL07031E0	1/2	15	1/2-14	1	1.77	1.50	1.18	1.06	45	38	30	27	0.43	195
LL0704100	LL07041V0	LL07041E0	3/4	20	3/4-14	1	2.20	1.89	1.50	1.38	56	48	38	35	0.86	391
LL0705100	LL07051V0	LL07051E0	1	25	1-11	1	2.40	2.05	1.77	1.61	61	52	45	41	1.07	484
-	LL07061V0	LL07061E0	1 1/4	33	1 1/4-11	1	2.64	2.95	2.36	2.16	67	75	60	55	2.37	1073
-	LL07071V0	LL07071E0	1 1/2	40	1 1/2-11	1	3.38	3.35	2.83	2.56	86	85	72	65	4.23	1920
-	LL07091V0	LL07091E0	2	50	2-11	1	3.46	3.82	3.27	2.95	88	97	83	75	4.52	2052

* Body sizes 1 1/4, 1 1/2 and 2 are supplied with FKM seals as a standard.

** Alternative end connections available upon request.

To obtain connected length of coupling add dimensions A (Fig. 1) and G (Fig. 2) together

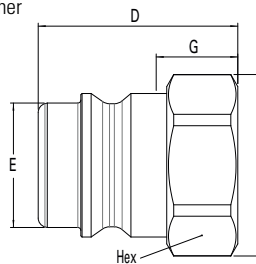

Figure 2

Plugs (Male)

Part Number	Body Size (in)	Nominal Flow Diameter (mm)	Thread Size* (Female)	BSP	Fig.	Dimensions								Weight		
						D (in)	E (in)	F (in)	G (in)	Hex (in)	D (mm)	E (mm)	F (mm)	G (mm)	Hex (mm)	lbs
LL0700200	1/8	8	1/8-28	2	1.02	0.43	0.72	0.41	0.63	26	11	18.4	10.5	16	0.05	21
LL0701200	1/4	10	1/4-19	2	1.00	0.56	0.82	0.41	0.75	25.5	14.2	21	10.5	19	0.06	29
LL0702200	3/8	12	3/8-19	2	1.10	0.75	1.02	0.42	0.90	28	19	26	10.7	23	0.11	50
LL0703200	1/2	15	1/2-14	2	1.30	0.81	1.18	0.51	1.06	33	20.6	30	13	27	0.13	59
LL0704200	3/4	20	3/4-14	2	1.57	1.10	1.50	0.55	1.38	40	27.9	38	14	35	0.28	129
LL0705200	1	25	1-11	2	1.73	1.27	1.77	0.73	1.61	44	32.4	45	18.5	41	0.38	171
LL0706200	1 1/4	33	1 1/4-11	2	2.12	1.73	2.36	0.83	2.16	54	44	60	21	55	1.03	466
LL0707200	1 1/2	40	1 1/2-11	2	2.32	2.10	2.83	0.87	2.56	59	53.5	71.9	22	65	1.59	722
LL0709200	2	50	2-11	2	2.68	2.47	3.27	1.06	2.95	68	62.8	83	27	75	2.04	923

* Alternative end connections available upon request.

To obtain connected length of coupling add dimensions A (Fig. 1) and G (Fig. 2) together.

L7000 Series Full Flow (Brass)

Dust Plugs and Dust Caps

Body Size (in)	Socket Dust Plug Part Number Anodized Aluminum	Plug Dust Cap Part Number Anodized Aluminum
1/8	HD0510100	HD0510200
1/4	HD0511100	HD0511200
3/8	HD0512100	HD0512200
1/2	HD0513100	HD0513200
3/4	HD0514100	HD0514200
1	HD0515100	HD0515200
1 1/4	HD0516100	HD0516200
1 1/2	HD0517100	HD0517200
2	HD0519100	HD0519200



Seal Kit for Servicing Sockets (Female)

Body Size (in)	Seal & Back-up Ring Kit*					
	NBR seals & PTFE back-up rings	Qty	FKM seals & PTFE back-up rings	Qty	EPDM seals & PTFE back-up rings	Qty
1/8	HG 05001 00	50 O-rings + 50 Backup rings	HG 05001 V0	15 O-rings + 15 Backup rings	HG 05001 E0	15 O-rings + 15 Backup rings
1/4	HG 05011 00	50 O-rings + 50 Backup rings	HG 05011 V0	15 O-rings + 15 Backup rings	HG 05011 E0	15 O-rings + 15 Backup rings
3/8	HG 05021 00	50 O-rings + 50 Backup rings	HG 05021 V0	15 O-rings + 15 Backup rings	HG 05021 E0	15 O-rings + 15 Backup rings
1/2	HG 05031 00	50 O-rings + 50 Backup rings	HG 05031 V0	15 O-rings + 15 Backup rings	HG 05031 E0	15 O-rings + 15 Backup rings
3/4	HG 05041 00	50 O-rings + 50 Backup rings	HG 05041 V0	15 O-rings + 15 Backup rings	HG 05041 E0	15 O-rings + 15 Backup rings
1	HG 05051 00	50 O-rings + 50 Backup rings	HG 05051 V0	10 O-rings + 10 Backup rings	HG 05051 E0	10 O-rings + 10 Backup rings
1 1/4	LG 07061 00	15 O-rings + 15 Backup rings	HG 05061 V0	5 O-rings + 5 Backup rings	-	-
1 1/2	LG 07071 00	15 O-rings + 15 Backup rings	-	-	-	-
2	LG 07091 00	15 O-rings + 15 Backup rings	-	-	-	-

*The valve seal is not included in our repair kits

FLUID TRANSFER
AND HYDRAULIC

PNEUMATIC

SPECIAL APPLICATIONS

DIAGNOSTIC

AGRICULTURE

REFRIGERANT

L7000 Series Full Flow (Stainless Steel)



Eaton's L7000 Series stainless steel quick disconnect coupling is a full-flow coupling suited for applications where maximum flow capacity is required and valving is not needed. Mainly used in fluid transfer applications and offers excellent corrosion resistance.

Product Features

- Proprietary profile
- Full flow pull-to-connect couplings
- Ball-locking
- Excellent flow performance
- Standard body material: AISI 316L Stainless steel
- Optional dust caps and plugs (made of anodized aluminum)
- Standard seal material: FKM, EPDM

European Pressure Equipment Directive*

Couplings with nominal diameters up to and including 25 mm are designed and manufactured under Article 4.3 of the European Pressure Equipment Directive PED 2014/68/EU. Couplings with nominal diameters greater than 25 mm are designed and manufactured in accordance with the stipulations of Module A of the European Pressure Equipment Directive PED 2014/68/EU. They should not be used to convey unstable gases.

*Group 1 = Hazardous media / Group 2 = Other media

Applications & Markets

- Pressure Washing
- Steam-cleaning Equipment
- Fluid Transfer Lines
- Refrigerant Circuits
- Applications where maximum flow capacity is required

Physical Characteristics

Body Size (in)	Nominal Flow Diameter (mm)	Max. Operating Pressure (connected) Non hazardous liquids & gases			
		Group 2		Group 1	
		(bar)	(psi)	(bar)	(psi)
1/8	8	300	4,350	300	4,350
1/4	10	230	3,335	230	3,335
3/8	12	175	3,535	175	3,535
1/2	15	150	2,175	150	2,175
3/4	20	125	1,810	125	1,810
1	25	100	1,450	100	1,450
1 1/4	33	100	1,450	100	1,450
1 1/2	40	75	1,085	38	550
2	50	40	580	28	405

Flow Data

The nominal flow diameter of the coupling has no impact on pressure drop, as it is wider than the circuit diameter.

Seal Elastomer Data*

Seal Elastomer	Max. Operation Temperature Range
FKM (Fluorocarbon)	-20°C +200°C/-4°F +392°F
EPDM (Ethylene-Propylene)**	-40°C +150°C/-40°F +302°F

*For reference only, based on Eaton recommended temperatures.

**In accordance with NFL 17-241 or NAS 1613 rev. 5, depending on size.

Contact Eaton technical support for further information on fluid compatibility.

L7000 Series Full Flow (Stainless Steel)

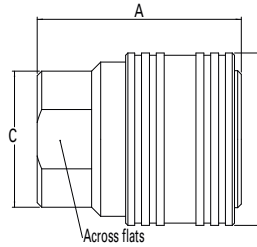

Figure 1

Sockets (Female)

Part Number	Body Size	Nominal Flow Diameter	Thread Size* (Female)	Fig.	Dimensions									Weight	
					A (in)	B (in)	C (in)	Across flats (in)	A (mm)	B (mm)	C (mm)	Across flats (mm)	lbs	grams	
LZ07001V0	LZ07001E0	1/8	8	1/8-28	1	1.63	0.94	0.83	0.63	41.5	24	21	16	0.19	86
LZ07011V0	LZ07011E0	1/4	10	1/4-19	1	1.42	1.10	0.83	0.75	36	28	21	19	0.19	87
LZ07021V0	LZ07021E0	3/8	12	3/8-19	1	1.50	1.34	1.02	0.90	38	34	26	23	0.28	129
LZ07031V0	LZ07031E0	1/2	15	1/2-14	1	1.77	1.50	1.18	1.06	45	38	30	27	0.39	177
LZ07041V0	LZ07041E0	3/4	20	3/4-14	1	2.20	1.89	1.50	1.38	56	48	38	35	0.78	355
LZ07051V0	LZ07051E0	1	25	1-11	1	2.40	2.05	1.77	1.61	61	52	45	41	0.97	440
LZ07061V0	LZ07061E0	1 1/4	33	1 1/4-11	1	2.64	2.95	2.36	2.16	67	75	60	55	2.15	975
LZ07071V0	LZ07071E0	1 1/2	40	1 1/2-11	1	3.38	3.35	2.83	2.56	86	85	72	65	3.85	1745
LZ07091V0	LZ07091E0	2	50	2-11	1	3.46	3.82	3.27	2.95	88	97	83	75	4.11	1865

*Alternative end connections available upon request.

To obtain connected length of coupling add dimensions A (Fig. 1) and G (Fig. 2) together

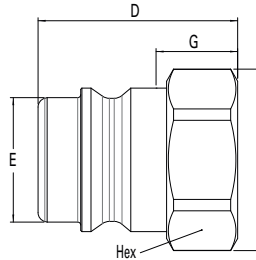

Figure 2

Plugs (Male)

Part Number	Body Size	Nominal Flow Diameter	Thread Size* (Female)	Fig.	Dimensions										Weight	
					D (in)	E (in)	F (in)	G (in)	Hex (in)	D (mm)	E (mm)	F (mm)	G (mm)	Hex (mm)	lbs	grams
LZ0700200	1/8	8	1/8-28	2	1.02	0.43	0.72	0.41	0.63	26	11.0	18.4	10.5	16	0.04	19
LZ0701200	1/4	10	1/4-19	2	1.00	0.56	0.82	0.41	0.75	25.5	14.2	21	10.5	19	0.06	26
LZ0702200	3/8	12	3/8-19	2	1.10	0.75	1.02	0.42	0.90	28	19.0	26	10.7	23	0.10	45
LZ0703200	1/2	15	1/2-14	2	1.30	0.81	1.18	0.51	1.06	33	20.6	30	13	27	0.12	54
LZ0704200	3/4	20	3/4-14	2	1.57	1.10	1.50	0.55	1.38	40	27.9	38	14	35	0.26	117
LZ0705200	1	25	1-11	2	1.73	1.27	1.77	0.73	1.61	44	32.4	45	18.5	41	0.34	155
LZ0706200	1 1/4	33	1 1/4-11	2	2.12	1.73	2.36	0.83	2.16	54	44.0	60	21	55	0.94	424
LZ0707200	1 1/2	40	1 1/2-11	2	2.32	2.10	2.83	0.87	2.56	59	53.5	71.9	22	65	1.45	656
LZ0709200	2	50	2-11	2	2.68	2.47	3.27	1.06	2.95	68	62.8	83	27	75	1.85	839

*Alternative end connections available upon request.

To obtain connected length of coupling add dimensions A (Fig. 1) and G (Fig. 2) together.

FLUID TRANSFER
AND HYDRAULIC

PNEUMATIC

SPECIAL APPLICATIONS

DIAGNOSTIC

AGRICULTURE

REFRIGERANT

L7000 Series Full Flow (Stainless Steel)

FLUID TRANSFER
AND HYDRAULIC

Dust Plugs and Dust Caps

Body Size	Socket Dust Plug Part Number	Plug Dust Cap Part Number
(in)	Anodized Aluminum	Anodized Aluminum
1/8	HD0510100	HD0510200
1/4	HD0511100	HD0511200
3/8	HD0512100	HD0512200
1/2	HD0513100	HD0513200
3/4	HD0514100	HD0514200
1	HD0515100	HD0515200
1 1/4	HD0516100	HD0516200
1 1/2	HD0517100	HD0517200
2	HD0519100	HD0519200

Socket dust plug



Plug dust cap

PNEUMATIC

Seal Kit for Servicing Sockets (Female)

Body Size	Seal & Back-up Ring Kit*					
	(in)	NBR seals & PTFE back-up rings	Qty	FKM seals & PTFE back-up rings	Qty	EPDM seals & PTFE back-up rings
1/8	HG 05001 00	50 O-rings + 50 Backup rings	HG 05001 V0	15 O-rings + 15 Backup rings	HG 05001 E0	15 O-rings + 15 Backup rings
1/4	HG 05011 00	50 O-rings + 50 Backup rings	HG 05011 V0	15 O-rings + 15 Backup rings	HG 05011 E0	15 O-rings + 15 Backup rings
3/8	HG 05021 00	50 O-rings + 50 Backup rings	HG 05021 V0	15 O-rings + 15 Backup rings	HG 05021 E0	15 O-rings + 15 Backup rings
1/2	HG 05031 00	50 O-rings + 50 Backup rings	HG 05031 V0	15 O-rings + 15 Backup rings	HG 05031 E0	15 O-rings + 15 Backup rings
3/4	HG 05041 00	50 O-rings + 50 Backup rings	HG 05041 V0	15 O-rings + 15 Backup rings	HG 05041 E0	15 O-rings + 15 Backup rings
1	HG 05051 00	50 O-rings + 50 Backup rings	HG 05051 V0	10 O-rings + 10 Backup rings	HG 05051 E0	10 O-rings + 10 Backup rings
1 1/4	LG 07061 00	15 O-rings + 15 Backup rings	HG 05061 V0	5 O-rings + 5 Backup rings	-	-
1 1/2	LG 07071 00	15 O-rings + 15 Backup rings	-	-	-	-
2	LG 07091 00	15 O-rings + 15 Backup rings	-	-	-	-

*The valve seal is not included in our repair kits

SPECIAL APPLICATIONS

DIAGNOSTIC

AGRICULTURE

REFRIGERANT

R4000 Series (Steel)



Product Features

- Standard body material: Zinc-plated steel
- Standard seal material: NBR, FKM, EPDM

Operating Guidelines

The Eaton R4000 series is designed to handle liquids. Should applications involving gases (but not unstable gases) be considered, the user should certify that sonic frequencies will not exceed 1 Hz (one cycle per second). For further information, please contact Eaton technical support.

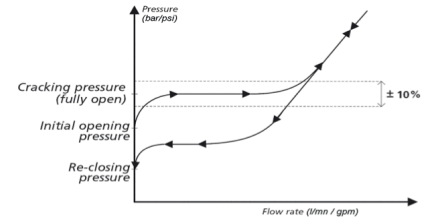

European Pressure Equipment Directive

Check valves with nominal diameters up to and including 25 mm are designed and manufactured under Article 4.3 of the European Pressure Equipment Directive PED 2014/68/EU. Check valves with nominal diameters greater than 25 mm are designed and manufactured with the stipulations of Module A of the European Pressure Equipment Directive PED 2014/68/EU. They should not be used to convey unstable gases. Our series R4000 check valves must not be used as safety devices (as per PED 2014/68/EU).

Applications & Markets

- All Industries
- Agriculture
- Construction
- Fluid Transfer Lines

Physical Characteristics

Body Size	Nominal Flow Diameter	Max. Operating Pressure**				Rated Flow*	
		Non hazardous liquids & gases in Group 2		Hazardous liquids & gases in Group 1		L/min	(gpm)
(in)	(mm)	bar	(psi)	bar	(psi)		
1/8	3.8	700	10,150	700	10,150	4.5	1.19
1/4	5.7	700	10,150	700	10,150	14.2	3.75
3/8	7.6	700	10,150	700	10,150	22	5.81
1/2	10.3	500	7,250	500	7,250	32	8.45
3/4	14.2	500	7,250	500	7,250	72	19
1	16.5	500	7,250	500	7,250	117	30.9
1 1/4	20.5	300	4,350	300	4,350	188	49.66
1 1/2	25.8	300	4,350	38	550	232	61.29
2	34.7	300	4,350	28	405	393	103.81

*Indicated values refer to a 1 bar/14.5 psi pressure drop.

**Group 1 = Hazardous media / Group 2 = Other media

Flow Data

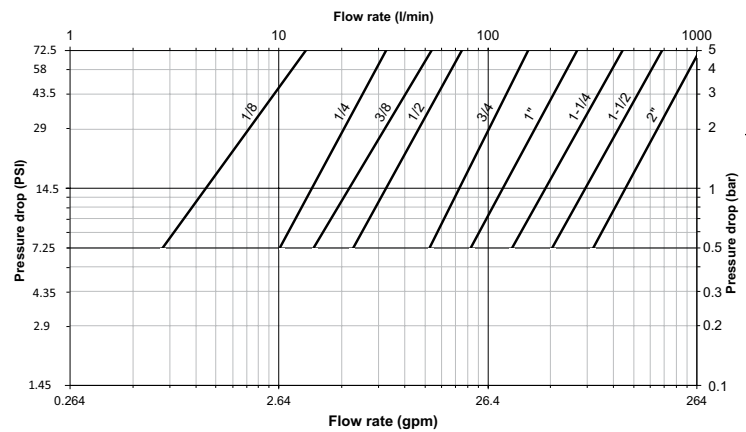

Seal Elastomer Data*

Seal Elastomer	Max. Operation Temperature Range
NBR (Nitrile)	-20°C +100°C/-4°F +212°F
FKM (Fluorocarbon)	-20°C +200°C/-4°F +392°F
EPDM (Ethylene-Propylene)**	-40°C +150°C/-40°F +302°F

*For reference only, based on Eaton recommended temperatures.

**In accordance with NF L 17-241 or NAS 1613 rev. 5

Contact Eaton technical support for further information on fluid compatibility.

R4000 Series (Steel)

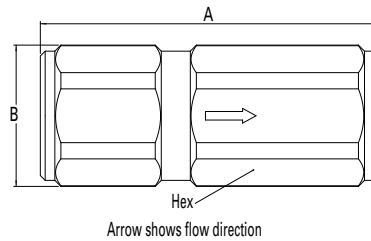

Figure 1

Cracking Pressure 0.5 bar (7.25 psi)

Part Number		Body Size (in)	Nominal Flow Diameter (mm)	Thread Size** (Female)	Fig.	Dimensions						Weight		
NBR*	FKM					EPDM	BSP	A (in)	B (in)	Hex (in)	A (mm)	B (mm)	Hex (mm)	lbs
RA0400000	RA04000V0	RA04000E0	1/8	3.8	1/8	1	1.46	0.69	0.63	37	17.5	16	0.10	45
RA0401000	RA04010V0	RA04010E0	1/4	5.7	1/4	1	1.97	0.83	0.75	50	21	19	0.18	80
RA0402000	RA04020V0	RA04020E0	3/8	7.6	3/8	1	2.36	0.98	0.90	60	25	23	0.29	130
RA0403000	RA04030V0	RA04030E0	1/2	10.3	1/2	1	2.75	1.15	1.06	70	29.2	27	0.44	200
RA0404000	RA04040V0	RA04040E0	3/4	14.2	3/4	1	3.38	1.50	1.38	86	38	35	0.93	420
RA0405000	RA04050V0	RA04050E0	1	16.5	1	1	3.94	1.77	1.61	100	45	41	1.41	640
-	RA04060V0	RA04060E0	1 1/4	20.5	1 1/4	1	5.12	2.40	2.16	130	61	55	3.46	1570
-	RA04070V0	RA04070E0	1 1/2	25.8	1 1/2	1	5.31	2.83	2.56	135	72	65	5.16	2340
-	RA04090V0	RA04090E0	2	34.7	2	1	5.90	3.30	2.95***	150	84	75***	6.57	2980

*Body size 1 1/4, 1 1/2 and 2 are supplied with FKM seals as a standard.

**Alternative end connections available upon request. depending on size (please contact Eaton technical support).

***Across flat dimension.

Cracking Pressure 1 bar (14.5 psi)

Part Number		Body Size (in)	Nominal Flow Diameter (mm)	Thread Size** (Female)	Fig.	Dimensions						Weight		
NBR*	FKM					EPDM	BSP	A (in)	B (in)	Hex (in)	A (mm)	B (mm)	Hex (mm)	lbs
RA040000B	RA04000VB	RA04000EB	1/8	3.8	1/8	1	1.46	0.69	0.63	37	17.5	16	0.10	45
RA040100B	RA04010VB	RA04010EB	1/4	5.7	1/4	1	1.97	0.83	0.75	50	21	19	0.18	80
RA040200B	RA04020VB	RA04020EB	3/8	7.6	3/8	1	2.36	0.98	0.90	60	25	23	0.29	130
RA040300B	RA04030VB	RA04030EB	1/2	10.3	1/2	1	2.75	1.15	1.06	70	29.2	27	0.44	200
RA040400B	RA04040VB	RA04040EB	3/4	14.2	3/4	1	3.38	1.50	1.38	86	38	35	0.93	420
RA040500B	RA04050VB	RA04050EB	1	16.5	1	1	3.94	1.77	1.61	100	45	41	1.41	640
-	RA04060VB	RA04060EB	1 1/4	20.5	1 1/4	1	5.12	2.40	2.16	130	61	55	3.46	1570
-	RA04070VB	RA04070EB	1 1/2	25.8	1 1/2	1	5.31	2.83	2.56	135	72	65	5.16	2340
-	RA04090VB	RA04090EB	2	34.7	2	1	5.90	3.30	2.95***	150	84	75***	6.57	2980

*Body size 1 1/4, 1 1/2 and 2 are supplied with FKM seals as a standard.

**Alternative end connections available upon request. depending on size (please contact Eaton technical support).

***Across flat dimension.

R4000 Series (Brass)



The Eaton R4000 Series brass check-valves are designed to either allow flow of fluid in one direction only or limit the line's internal pressure to the cracking pressure. Standard cracking pressures are 0.5 and 1 bar (7.25 and 14.5 psi). Alternatives can be offered upon request. It is designed to handle liquids in all industries and for fluid transfer lines.

Product Features

- Standard body material: Nickel-plated brass
- Standard seal material: NBR, FKM, EPDM

Operating Guidelines

The Eaton R4000 series is designed to handle liquids. Should applications involving gases (but not unstable gases) be considered, the user should certify that sonic frequencies will not exceed 1 Hz (one cycle per second). For further information, please contact Eaton technical support.

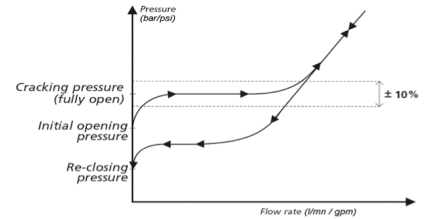

European Pressure Equipment Directive

All check valves are designed and manufactured under Article 4.3 of the European Pressure Equipment Directive PED 2014/68/EU. Check valves with nominal diameters greater than 25 mm should not be used to convey gases in Group 1 (hazardous). Working pressures for liquids of Group 1 (hazardous) and gases of Group 2 (non-hazardous) are reduced. Please refer to "Physical Characteristics" table. Our series R4000 check valves must not be used as safety devices (as per PED 2014/68/EU).

Physical Characteristics

Body Size	Nominal Flow Diameter	Max. Operating Pressure**				Rated Flow*	
		Non hazardous liquids		Hazardous liquids & Non-Hazardous Gases			
(in)	(mm)	bar	(psi)	bar	(psi)	L/min	(gpm)
1/8	3.8	400	5,800	400	5,800	4.5	1.19
1/4	5.7	400	5,800	400	5,800	14.2	3.75
3/8	7.6	400	5,800	400	5,800	22	5.81
1/2	10.3	250	3,625	250	3,625	32	8.45
3/4	14.2	250	3,625	250	3,625	72	19
1	16.5	250	3,625	250	3,625	117	30.9
1 1/4	20.5	150	2,175	150	2,175	188	49.66
1 1/2	25.8	150	2,175	75	1,085	232	61.29
2	34.7	100	1,450	25	360	393	103.81

*Indicated values refer to a 1 bar/14.5 psi pressure drop.

**Group 1 = Hazardous media / Group 2 = Other media

Applications & Markets

- All Industries
- Agriculture
- Construction
- Fluid Transfer Lines

Flow Data

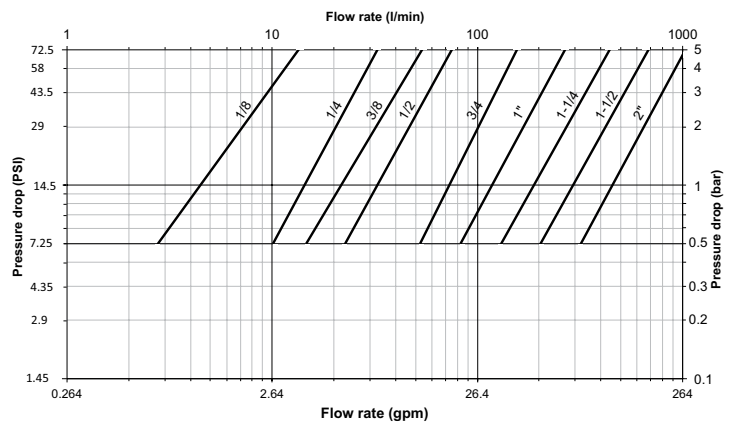

Applicable to valves with 0.5 bar (7.25 psi) cracking pressure

Seal Elastomer Data*

Seal Elastomer	Max. Operation Temperature Range
NBR (Nitrile)	-20°C +100°C/-4°F +212°F
FKM (Fluorocarbon)	-20°C +200°C/-4°F +392°F
EPDM (Ethylene-Propylene)**	-40°C +150°C/-40°F +302°F

*For reference only, based on Eaton recommended temperatures.

**In accordance with NF L 17-241 or NAS 1613 rev. 5

Contact Eaton technical support for further information on fluid compatibility.

R4000 Series (Brass)

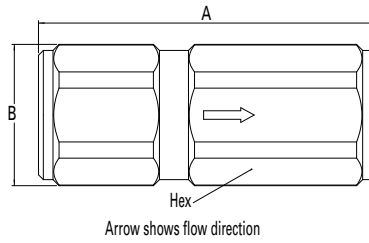

Figure 1

Cracking Pressure 0.5 bar (7.25 psi)

Part Number			Body Size (in)	Nominal Flow Diameter (mm)	Thread Size** (Female)	Fig.	Dimensions						Weight	
NBR*	FKM	EPDM					A (in)	B (in)	Hex (in)	A (mm)	B (mm)	Hex (mm)	lbs	grams
RL0400000	RL04000V0	RL04000E0	1/8	3.8	1/8	1	1.46	0.69	0.63	37	175	16	0.11	50
RL0401000	RL04010V0	RL04010E0	1/4	5.7	1/4	1	1.97	0.83	0.75	50	21	19	0.19	85
RL0402000	RL04020V0	RL04020E0	3/8	7.6	3/8	1	2.36	0.98	0.9	60	25	23	0.31	140
RL0403000	RL04030V0	RL04030E0	1/2	10.3	1/2	1	2.75	1.15	1.06	70	29.2	27	0.47	215
RL0404000	RL04040V0	RL04040E0	3/4	14.2	3/4	1	3.38	1.50	1.38	86	38	35	1.01	460
RL0405000	RL04050V0	RL04050E0	1	16.5	1	1	3.94	1.77	1.61	100	45	41	1.52	690
-	RL04060V0	RL04060E0	1 1/4	20.5	1 1/4	1	5.12	2.40	2.16	130	61	55	3.73	1690
-	RL04070V0	RL04070E0	1 1/2	25.8	1 1/2	1	5.31	2.83	2.56	135	72	65	5.71	2590
-	RL04090V0	RL04090E0	2	34.7	2	1	5.90	3.30	2.95***	150	84	75***	7.50	3400

*Body sizes 1/4, 1/2 and 2 are supplied with FKM seals as a standard.

**Alternative end connections available upon request, depending on size (please contact Eaton technical support).

***Across flat dimension.

Cracking Pressure 1 bar (14.5 psi)

Part Number			Body Size (in)	Nominal Flow Diameter (mm)	Thread Size** (Female)	Fig.	Dimensions						Weight	
NBR*	FKM	EPDM					A (in)	B (in)	Hex (in)	A (mm)	B (mm)	Hex (mm)	lbs	grams
RL040000B	RL04000VB	RL04000EB	1/8	3.8	1/8	1	1.46	0.69	0.63	37	175	16	0.11	50
RL040100B	RL04010VB	RL04010EB	1/4	5.7	1/4	1	1.97	0.83	0.75	50	21	19	0.19	85
RL040200B	RL04020VB	RL04020EB	3/8	7.6	3/8	1	2.36	0.98	0.90	60	25	23	0.31	140
RL040300B	RL04030VB	RL04030EB	1/2	10.3	1/2	1	2.75	1.15	1.06	70	29.2	27	0.47	215
RL040400B	RL04040VB	RL04040EB	3/4	14.2	3/4	1	3.38	1.50	1.38	86	38	35	1.01	460
RL040500B	RL04050VB	RL04050EB	1	16.5	1	1	3.94	1.77	1.61	100	45	41	1.52	690
-	RL04060VB	RL04060EB	1 1/4	20.5	1 1/4	1	5.12	2.40	2.16	130	61	55	3.73	1690
-	RL04070VB	RL04070EB	1 1/2	25.8	1 1/2	1	5.31	2.83	2.56	135	72	65	5.71	2590
-	RL04090VB	RL04090EB	2	34.7	2	1	5.90	3.30	2.95***	150	84	75***	7.50	3400

*Body sizes 1/4, 1/2 and 2 are supplied with FKM seals as a standard.

**Alternative end connections available upon request, depending on size (please contact Eaton technical support).

***Across flat dimension.

R4000 Series (Stainless Steel)



Product Features

- Standard body material: AISI 316L Stainless steel
- Standard seal material: FKM, EPDM

Operating Guidelines

The Eaton R4000 series is designed to handle liquids. Should applications involving gases (but not unstable gases) be considered, the user should certify that sonic frequencies will not exceed 1 Hz (one cycle per second). For further information, please contact Eaton technical support.

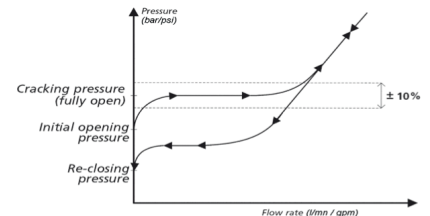

European Pressure Equipment Directive

Check valves with nominal diameters up to and including 25 mm are designed and manufactured under Article 4.3 of the European Pressure Equipment Directive PED 2014/68/EU. Check valves with nominal diameters greater than 25 mm are designed and manufactured in accordance with the stipulations of Module A of the European Pressure Equipment Directive PED 2014/68/EU. They should not be used to convey unstable gases. Our series R4000 check valves must not be used as safety devices (as per PED 2014/68/EU).

Physical Characteristics

Body Size (in)	Nominal Flow Diameter (mm)	Max. Operating Pressure**				Rated Flow*	
		Non hazardous liquids & gases Group 2		Hazardous liquids & gases Group 1		L/min	(gpm)
1/8	3.8	400	5,800	400	5,800	4.5	1.19
1/4	5.7	400	5,800	400	5,800	14.2	3.75
3/8	7.6	400	5,800	400	5,800	22	5.81
1/2	10.3	250	3,625	250	3,625	32	8.45
3/4	14.2	250	3,625	250	3,625	72	19.00
1	16.5	250	3,625	250	3,625	117	30.90
1 1/4	20.5	150	2,175	150	2,175	188	49.66
1 1/2	25.8	150	2,175	38	550	232	61.29
2	34.7	100	1,450	28	405	393	103.81

*Indicated values refer to a 1 bar / 14.5 psi pressure drop.

**Group 1 = Hazardous media / Group 2 = Other media

Applications & Markets

- All Industries
- Agriculture
- Construction
- Fluid Transfer Lines

Flow Data

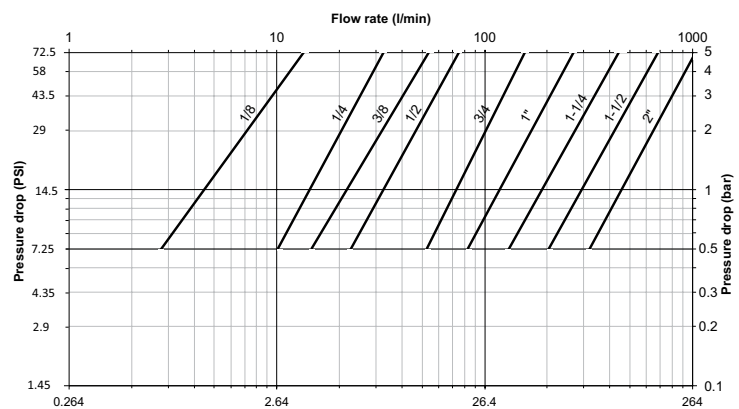

Applicable to valves with 0.5 bar (7.25 psi) cracking pressure

Seal Elastomer Data*

Seal Elastomer	Max. Operation Temperature Range
FKM (Fluorocarbon)*	-20°C +200°C/-4°F +392°F
EPDM (Ethylene-Propylene)**	-40°C +150°C/-40°F +302°F

*For reference only, based on Eaton recommended temperatures.

**In accordance with NF L 17-241 or NAS 1613 rev. 5

Contact Eaton technical support for further information on fluid compatibility.

R4000 Series (Stainless Steel)

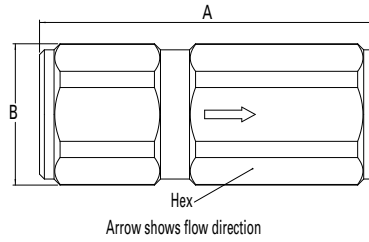

Figure 1

Cracking Pressure 0.5 bar (7 psi)

Part Number		Body Size	Nominal Flow Diameter	Thread Size* (Female)	Fig.	Dimensions						Weight	
FKM	EPDM	(in)	(mm)	BSP		A (in)	B (in)	Hex (in)	A (mm)	B (mm)	Hex (mm)	lbs	grams
RZ04000V0	RZ04000E0	1/8	3.8	1/8	1	1.46	0.69	0.63	37	17.5	16	0.10	45
RZ04010V0	RZ04010E0	1/4	5.7	1/4	1	1.97	0.83	0.75	50	21	19	0.18	80
RZ04020V0	RZ04020E0	3/8	7.6	3/8	1	2.36	0.98	0.90	60	25	23	0.29	130
RZ04030V0	RZ04030E0	1/2	10.3	1/2	1	2.75	1.15	1.06	70	29.2	27	0.44	200
RZ04040V0	RZ04040E0	3/4	14.2	3/4	1	3.38	1.50	1.38	86	38	35	0.93	420
RZ04050V0	RZ04050E0	1	16.5	1	1	3.94	1.77	1.61	100	45	41	1.41	640
RZ04060V0	RZ04060E0	1 1/4	20.5	1 1/4	1	5.12	2.40	2.16	130	61	55	3.46	1570
RZ04070V0	RZ04070E0	1 1/2	25.8	1 1/2	1	5.31	2.83	2.56	135	72	65	5.16	2340
RZ04090V0	RZ04090E0	2	34.7	2	1	5.90	3.30	2.95**	150	84	75**	6.57	2980

*Alternative end connections available upon request, depending on size (please contact Eaton technical support).

**Across flat dimension.

Cracking Pressure 1 bar (14.5 psi)

Part Number		Body Size	Nominal Flow Diameter	Thread Size* (Female)	Fig.	Dimensions						Weight	
FKM	EPDM	(in)	(mm)	BSP		A (in)	B (in)	Hex (in)	A (mm)	B (mm)	Hex (mm)	lbs	grams
RZ04000VB	RZ04000EB	1/8	3.8	1/8	1	1.46	0.69	0.63	37	17.5	16	0.10	45
RZ04010VB	RZ04010EB	1/4	5.7	1/4	1	1.97	0.83	0.75	50	21	19	0.18	80
RZ04020VB	RZ04020EB	3/8	7.6	3/8	1	2.36	0.98	0.90	60	25	23	0.29	130
RZ04030VB	RZ04030EB	1/2	10.3	1/2	1	2.75	1.15	1.06	70	29.2	27	0.44	200
RZ04040VB	RZ04040EB	3/4	14.2	3/4	1	3.38	1.50	1.38	86	38	35	0.93	420
RZ04050VB	RZ04050EB	1	16.5	1	1	3.94	1.77	1.61	100	45	41	1.41	640
RZ04060VB	RZ04060EB	1 1/4	20.5	1 1/4	1	5.12	2.40	2.16	130	61	55	3.46	1570
RZ04070VB	RZ04070EB	1 1/2	25.8	1 1/2	1	5.31	2.83	2.56	135	72	65	5.16	2340
RZ04090VB	RZ04090EB	2	34.7	2	1	5.90	3.30	2.95**	150	84	75**	6.57	2980

*Alternative end connections available upon request depending on size (please contact Eaton technical support).

**Across flat dimension.

FD15 Series Oil Sampling Valve



Product Features

- Standard seal material: Buna-N
- Corrosion resistant plated steel with brass internal components
- Operating Temperature Range: -65°F to +275°F (-53°C to +135°C)
- Minimum Burst Pressure: 12,000 psi
- Minimum Particle Restriction: 500 microns
- Maximum Torque to Operate: 10 in. lbs.
- FD15-1000-04 is qualified to the MIL-V-81940/2-1

Note: This valve is not intended for aerospace applications.

Applications & Markets

- Engine oil
- Lubricating oil
- Transmission fluid and hydraulic fluids in mobile construction equipment, military vehicles, trucks and stationary equipment

Operation

- For best results, Eaton FD15 Oil Sampling Valves should be installed in dynamic fluid lines in low pressure and return lines. If only one sampling point can be chosen, it should be in the return line, upstream of any return line filter. This will insure a representative sample of all components in the fluid system for their present condition.

Instructions

1. Remove metal dustcover on discharge port.
2. Discharge approximately 200 ml of oil to flush valve by turning knurled knob ¼ turn to the right. Dispose of this sample in the appropriate manner.
3. Locate clean oil sample bottle under discharge port. (Sample bottles are usually supplied by the oil analysis lab.)
4. Turn knurled knob ¼ turn to the right until bottle is filled to the desired level. The knob can be backed off to throttle the rate of flow.
5. When bottle is filled let go of the knurled knob, the valve will close automatically. Replace metal dustcover wrench tight.

Notes

As required in MIL-V-81940/2-1 this valve's flow rate is between 100 and 1500 milliliters per minute at pressures from 0–50 psi. (MIL-V-81940/2-1 applies only to pressures from 50–300 psi.)

The ¼" NPTF version is qualified to MIL-V-81940/2-1 and its performance is representative of the other inlet port configurations listed above. QPL-81940-9 6-5-89

FD15 Series Oil Sampling Valve

FLUID TRANSFER
AND HYDRAULIC

PNEUMATIC

SPECIAL APPLICATIONS

DIAGNOSTIC

AGRICULTURE

REFRIGERANT

**Male Pipe Thread
50-300 psi**

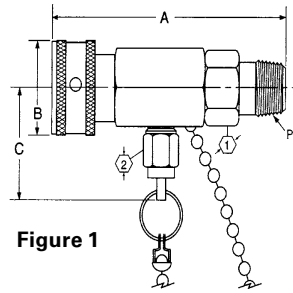

Figure 1

**Male SAE O-Ring Thread
50-300 psi**

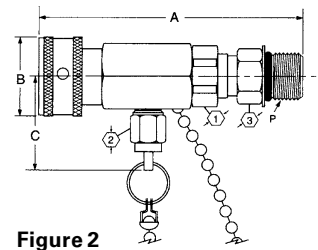

Figure 2

Dimensions (Male Pipe Thread)

Part Number Buna-N	Sampling Type	Port Size	Thread	Type	Fig.	Dimensions						
						A	B	C	Hex ①	Hex ②	Hex ③	
						mm (in)	mm (in)	mm (in)	mm (in)	mm (in)	mm (in)	
FD15-1000-02	50-300 psi	1/8	1/8-27	Male Pipe Thread	1	61.5 (2.42)	25.4 (1.00)	33.0 (1.30)	175 (.69)	9.7 (.38)	-	-
FD15-1000-04	50-300 psi	1/4	1/4-18	Male Pipe Thread	1	65.0 (2.56)	25.4 (1.00)	33.0 (1.30)	175 (.69)	9.7 (.38)	-	-

Dimensions (Male SAE O-Ring Thread)

Part Number Buna-N	Sampling Type	Port Size	Thread	Type	Fig.	Dimensions						
						A	B	C	Hex ①	Hex ②	Hex ③	
						mm (in)	mm (in)	mm (in)	mm (in)	mm (in)	mm (in)	
FD15-1002-04	50-300 psi	7/16	7/16-20	Male SAE O-Ring Thread	2	70.9 (2.79)	25.4 (1.00)	33.0 (1.30)	175 (.69)	9.7 (.38)	14.2 (.56)	

Dimensions (Male Pipe Thread)

Part Number Buna-N	Sampling Type	Port Size	Thread	Type	Fig.	Dimensions						
						A	B	C	Hex ①	Hex ②	Hex ③	
						mm (in)	mm (in)	mm (in)	mm (in)	mm (in)	mm (in)	
FD15-1026-04	0-50 psi	1/4	1/4-18	Male Pipe Thread	3	65.0 (2.56)	25.4 (1.00)	33.0 (1.30)	175 (.69)	9.7 (.38)	-	-

Dimensions Male SAE O-Ring Thread)

Part Number Buna-N	Sampling Type	Port Size	Thread	Type	Fig.	Dimensions						
						A	B	C	Hex ①	Hex ②	Hex ③	
						mm (in)	mm (in)	mm (in)	mm (in)	mm (in)	mm (in)	
FD15-1025-04	0-50 psi	7/16	7/16-20	Male SAE O-Ring Thread	4	70.9 (2.79)	25.4 (1.00)	33.0 (1.30)	175 (.69)	9.7 (.38)	14.2 (.56)	

**Male Pipe Thread
0-50 psi**

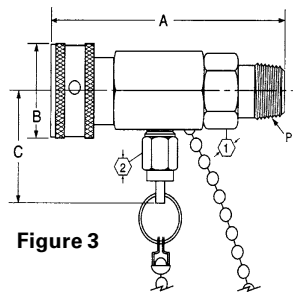

Figure 3

**Male SAE O-Ring Thread
0-50 psi**

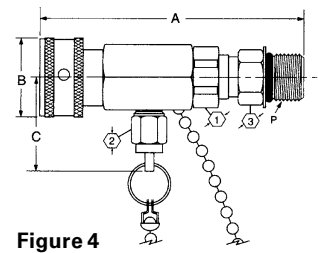

Figure 4

FD90 Series Diagnostic Coupling SAE J1502 Interchange



Eaton's FD90 Series diagnostic coupling is designed to connect and disconnect pressure gauges to hydraulic systems, eliminating the need for permanent gauges. The maximum operating pressure is 7,000 psi.

Product Features

- Automatic sleeve for one hand push-to-connect operation
- Self-sealing valve design allows connection and disconnection at 500 psi
- Standard seal material: Buna-N
- Diagnostic pressure testing for hydraulic systems
- Flush face valving provides minimal fluid loss and low air inclusion
- Broad range of end configurations for system accessibility
- Standard seal material: High resistance carbon steel with Zinc trivalent plating

Physical Characteristics

Coupling Body Size (in)	Max. Operating Pressure		Min. Burst Pressure Connected		Vacuum Connected Only	Rated Flow		Air Inclusion	Fluid Loss
	(bar)	(psi)	(bar)	(psi)	(in./Hg)	(lpm)	(gpm)	cc. max.	cc.max.
1/4	483	7,000	1,931	28,000	28	1.89	0.6	0.02	0.10

Dimensions (Female Pipe, Valved)

Part Number Buna-N	Part Number with Dust Cap Buna-N	Coupling Type	Body Size	Port Size	Thread	Type	Fig.	Dimensions				Hex ①	
								A		B			
				mm	(in)	mm	(in)	mm	(in)				
FD90-1034-02-04	FD90-1035-02-04	Plug/Male	1/4	1/8	1/8 - 27	Female NPT	1	43.2	(1.70)	-	-	15.7	(0.62)
FD90-1021-02-04	—	Socket/Female	1/4	1/8	1/8 - 27	Female NPT	2	49.5	(1.95)	25.4	(1.00)	19.1	(0.75)
FD90-1034-04-04	FD90-1035-04-04	Plug/Male	1/4	1/4	1/4 - 18	Female NPT	1	48.3	(1.90)	-	-	19.1	(0.75)
FD90-1021-04-04	—	Socket/Female	1/4	1/4	1/4 - 18	Female NPT	2	57.2	(2.25)	25.4	(1.00)	19.1	(0.75)

Dimensions (Male SAE O-Ring, Valved)

Part Number Buna-N	Part Number with Dust Cap Buna-N	Coupling Type	Body Size	Port Size	Thread	Type	Fig.	Dimensions				Hex ①	
								A		B			
				mm	(in)	mm	(in)	mm	(in)				
FD90-1044-03-04	FD90-1004-03-04	Plug/Male	1/4	3/8	3/8 - 24	Male SAE O-Ring	3	38.6	(1.52)	-	-	15.7	(0.62)
FD90-1044-04-04	FD90-1004-04-04	Plug/Male	1/4	7/16	7/16 - 20	Male SAE O-Ring	3	40.1	(1.58)	-	-	15.7	(0.62)
FD90-1044-05-04	FD90-1004-05-04	Plug/Male	1/4	1/2	1/2 - 20	Male SAE O-Ring	3	33.5	(1.32)	-	-	15.7	(0.62)
FD90-1044-06-04	FD90-1004-06-04	Plug/Male	1/4	9/16	9/16 - 18	Male SAE O-Ring	3	33.5	(1.32)	-	-	17.5	(0.69)

Dimensions (Male Pipe, Valved)

Part Number Buna-N	Part Number with Dust Cap Buna-N	Coupling Type	Body Size	Port Size	Thread	Type	Fig.	Dimensions				Hex ①	
								A		B			
				mm	(in)	mm	(in)	mm	(in)				
FD90-1012-02-04	FD90-1045-02-04	Plug/Male	1/4	1/8	1/8 - 27	Male NPT	4	40.6	(1.60)	-	-	15.7	(0.62)
FD90-1012-04-04	FD90-1045-04-04	Plug/Male	1/4	1/4	1/4 - 18	Male NPT	4	37.8	(1.49)	-	-	17.5	(0.69)

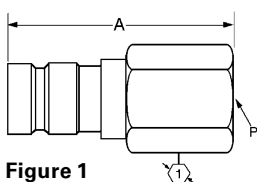

Figure 1

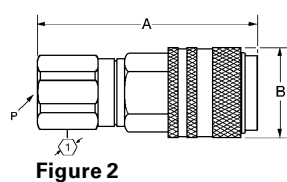

Figure 2

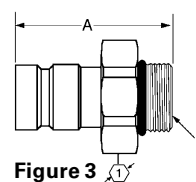

Figure 3

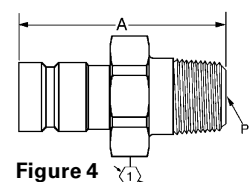

Figure 4

FD90 Series Diagnostic Coupling SAE J1502 Interchange

FLUID TRANSFER
AND HYDRAULIC

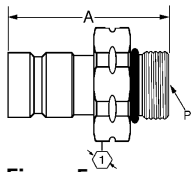

Figure 5

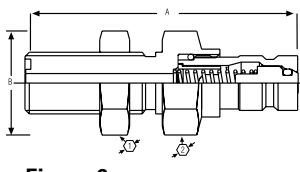

Figure 6

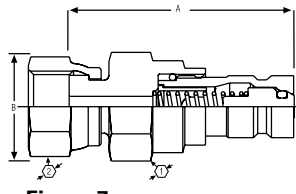

Figure 7

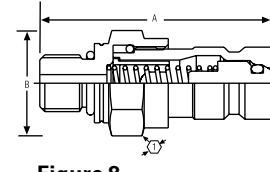

Figure 8

Dimensions (Metric Male O-Ring, Valved)

Part Number Buna-N	Part Number with Dust Cap Buna-N	Coupling Type	Body Size	Port Size	Thread	Type	Fig.	Dimensions		Hex ①	
								A	B	mm (in)	mm (in)
FD90-1046-06-04	FD90-1047-06-04	Plug/Male	¼	M14	M14x1.5	Male O-Ring	5	38.5 (1.52)	-	-	19.1 (0.75)

Dimensions (Female SAE O-Ring, Valved)

Part Number Buna-N	Coupling Type	Body Size	Port Size	Thread	Type	Fig.	Dimensions		Hex ①	
							A	B	mm (in)	mm (in)
FD90-1041-04-04	Socket/Female	¼	7/16	7/16 - 20	Female SAE O-Ring	2	55.9 (2.20)	25.40 (1.00)	19.1 (0.75)	

Dimensions (Male ORS Bulkhead, Valved)

Part Number Buna-N	Coupling Type	Body Size	Port Size	Thread	Type	Fig.	Dimensions		Hex ①	
							A	B	mm (in)	mm (in)
FD90-1206-04-04	Plug/Male	¼	9/16	9/16 - 18	Male ORS Bulkhead	6	62.5 (2.46)	20.6 (0.81)	20.6 (0.81)	

Dimensions (Male ORS Bulkhead, Valved)

Part Number Buna-N	Coupling Type	Body Size	Port Size	Thread	Type	Fig.	Dimensions		Hex ①	
							A	B	mm (in)	mm (in)
FD90-1061-04-04	Plug/Male	¼	9/16	9/16 - 18	Female ORS Swivel	7	46.5 (1.79)	22.1 (0.87)	17.5 (0.69)	
FD90-1061-06-04	Plug/Male	¼	11/16	11/16 - 16	Female ORS Swivel	7	46.5 (1.83)	23.9 (0.94)	20.6 (0.81)	
FD90-1061-08-04	Plug/Male	¼	13/16	13/16 - 16	Female ORS Swivel	7	49.0 (1.93)	27.4 (1.08)	23.9 (0.94)	

Dimensions (Male Metric O-Ring, Valved)

Part Number Buna-N	Coupling Type	Body Size	Port Size	Thread	Type	Fig.	Dimensions		Hex ①	
							A	B	mm (in)	mm (in)
FD90-1090-10-04	Plug/Male	¼	M10	M10x1	Mertic O-Ring	8	40.1 (1.58)	18.3 (0.72)	—	—

Dust Cap for Plug/Male Halves

Body Size	Part Number
¼	FD90-1040-04



Dust Cap for
Plug/Male Halves

SPECIAL APPLICATIONS

DIAGNOSTIC

AGRICULTURE

REFRIGERANT

K8000 Series



Eaton's K8000 series hydraulic screw-to-connect quick disconnect coupling is best for applications where vibration is present and a threaded solution is needed to lock in place.

Product Features

- Connection by screwing up the locking sleeve
- Offers internal flat face valve to minimize air inclusion and fluid loss
- Proprietary interchange
- Standard body material: Zinc trivalent plated steel
- Standard seal material: NBR

Physical Characteristics

DN/ND	Max. Operating Pressure		Rated Flow		Air Inclusion
	(bar)	(psi)	(bar)	(gpm)	ml max.
8	250	3,625	12	3.17	0.09

Applications & Markets

- Agriculture and Forestry Equipment

Flow Data

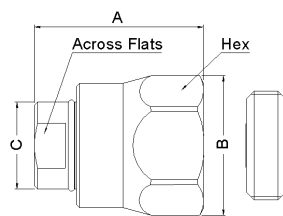
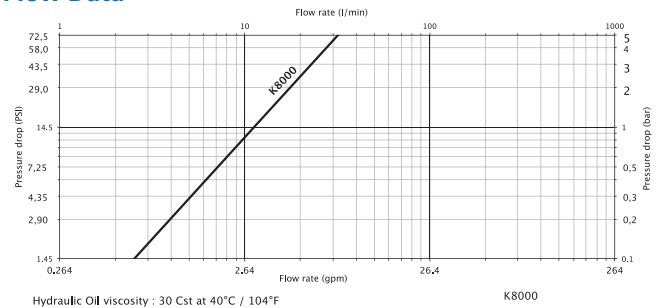

Figure 1

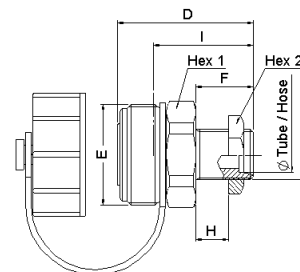

Figure 2

DN/ND	Socket and Dust Plug	Socket Dust Plug Only	Coupling Type	Connection	Fig.	Dimensions								
						A	B	C	Across Flats	Hex				
						(mm)	(mm)	(mm)	(mm)	(mm)				
8	KA0832718	KA0812700	Socket/Female	M18X150	1	55	45.1	279	23	41				
DN/ND	Plug and Dust Cap	Plug Dust Cap Only	Coupling Type	Connection	Fig.	Dimensions								
						D	E	F	G	H	I	Tube	Hex 1	Hex2
						(mm)	(mm)	(mm)	(mm)	(mm)	(mm)	(mm)	(mm)	(mm)
	KA0832412		Plug/Male	M18X150	2	52	36	23	M18X1,50	5	38	12	36	27
8	KA0832413	KP0812400	Plug/Male	M20X150	2	51	36	23	M20X1,50	5	37	13	36	27
	KA0802412		Plug/Male	G 1/2*	2	48	36	15	G 1/2-14*	-	34	-	36	-

Q9000 Series



Eaton's Q9000 Series is a brake away coupling used on agriculture and forestry vehicles.

Product Features

- Pull-to-connect double shut off
- Minimum air inclusion and fluid loss
- Profile in accordance to ISO 5676 and NFU 16-006 standards
- Standard seal material: NBR
- Standard body material: Zinc trivalent plated steel

Physical Characteristics

DN/ND	Max. Operating Pressure		Rated Flow		Air Inclusion
	(bar)	(psi)	(bar)	(gpm)	ml max.
8	150	2,175	19	5.02	0.80

Applications & Markets

- Trailer Brake Circuits on Agriculture and Forestry Vehicles

Flow Data

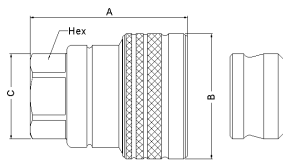
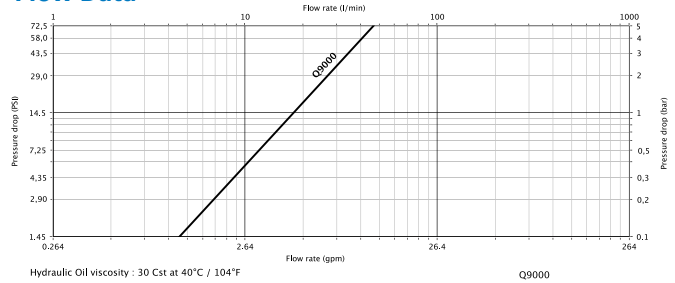

Figure 1

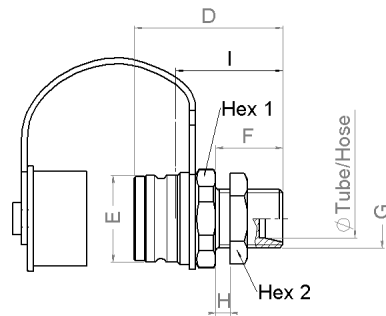

Figure 2

DN/ND	Socket and Dust Plug	Socket Dust Plug Only	Coupling Type	Connection	Fig.	A	Dimensions						
(mm)						(mm)	B	C	Hex				
8	QA0932118	QA0912100	Socket/Female	M18X150	1	55.5	44	30.2	27				
DN/ND	Plug and Dust Cap	Plug Dust Cap Only	Coupling Type	Connection	Fig.	D	Dimensions				Hex 1	Hex2	
(mm)						(mm)	E	F	G	H	I	(mm)	(mm)
8	QA0932212	QP0912200	Plug/Male	M18X150	2	49	30	21	M18x1,50	5	34	32	24
	QA0932213		Plug/Male	M20X150	2	51.0	30	23	M20x1,50	5	36	32	27

5400 Series Low Air Inclusion Refrigerant



Eaton's 5400 Series low air inclusion product line is designed for air conditioning, refrigerant, gaseous and fluid transfer applications.

Product Features

- Brazed or threaded end connections for versatility of installation on tubing or hose
- Tubular valve construction for low fluid loss and air inclusion
- Thread together design allows connection and disconnection against pressure
- Lock washer and jam nut standard for optional bulkhead mounting
- Standard seal material: Neoprene
- Guardian Seal™ plating for excellent corrosion resistance

Physical Characteristics

Coupling Size (in)	Max. Operating Pressure Connected		Min. Burst Pressure Connected		Max. Operating Pressure Disconnected				Vacuum Connected Only (in./Hg)	Rated Flow		Air Inclusion cc. max.	Fluid Loss cc.max.
	(bar)	(psi)	(bar)	(psi)	Male Half (bar)	(psi)	Female Half (bar)	(psi)		(lpm)	(gpm)		
1/4	207	3,000	621	9,000	172	2,500	52	750	28	8	2	.10	.05
1/2	121	1,750	359	5,200	121	1,750	52	750	28	53	14	.10	.10
3/4	48	700	145	2,100	48	700	45	650	28	132	35	.30	.10
1	48	700	145	2,100	48	700	21	300	28	284	75	.50	.20

Applications & Markets

- Mobile Air Conditioning and Refrigerant

Flow Data

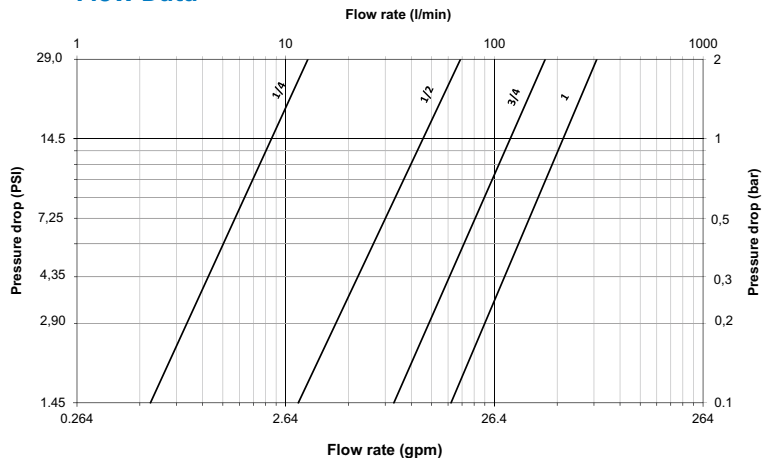

5400 Series Low Air Inclusion Refrigerant

FLUID TRANSFER
AND HYDRAULIC

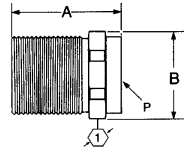

Figure 1

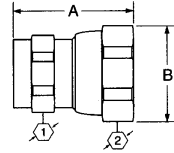

Figure 2

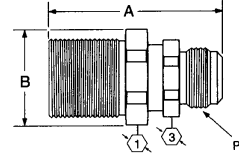

Figure 3

PNEUMATIC

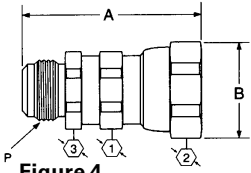

Figure 4

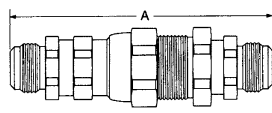

Figure 5

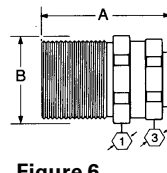

Figure 6

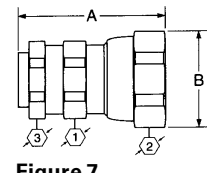

Figure 7

Dimensions – No Adapter

Part Number Neoprene	Coupling Type	Body Size	Type	Fig.	Dimensions		Hex ①		Hex ②		Hex ③			
					A	B	mm	(in)	mm	(in)	mm	(in)	mm	(in)
5400-S2-4	Male	¼	No Adapter	1	27.4	(1.08)	21.1	(.83)	19	(.75)	-	-	-	-
5400-S5-4	Female	¼	No Adapter	2	28.7	(1.13)	21.1	(.83)	16.0	(.63)	19	(.75)	-	-
5400-S2-8	Male	½	No Adapter	1	34.8	(1.37)	32.0	(1.26)	29.0	(1.14)	-	-	-	-
5400-S5-8	Female	½	No Adapter	2	40.6	(1.60)	33.0	(1.30)	26.0	(1.02)	30.0	(1.18)	-	-
5400-S2-12	Male	¾	No Adapter	1	44.2	(1.74)	46.4	(1.83)	41.0	(1.61)	-	-	-	-
5400-S5-12	Female	¾	No Adapter	2	55.1	(2.17)	45.0	(1.77)	35.0	(1.38)	41.0	(1.61)	-	-
5400-S2-16	Male	1	No Adapter	1	46.5	(1.83)	53.0	(2.10)	48.0	(1.89)	-	-	-	-
5400-S5-16	Female	1	No Adapter	2	61.1	(2.41)	56.0	(2.20)	45.0	(1.77)	50.0	(1.97)	-	-

Dimensions – SAE 37° (JIC) (Dimensional reference only)

Part Number Buna-N	Coupling Type	Body Size	Port Size	Thread	Type	Fig.	Dimensions		Hex ①		Hex ②		Hex ③			
							A	B	mm	(in)	mm	(in)	mm	(in)	mm	(in)
*Couplings must be ordered by components as shown on page 147.							mm	(in)	mm	(in)	mm	(in)	mm	(in)		
5410-S17-4-4*	Male	¼	7/16	7/16-20	SAE 37° (JIC)	3	47.8	(1.88)	21.1	(.83)	19	(.75)	-	-	16.0	(.63)
5410-S14-4-4*	Female	¼	7/16	7/16-20	SAE 37° (JIC)	4	49.0	(1.93)	21.1	(.83)	16.0	(.63)	19	(.75)	15.7	(.62)
5410-4-4*	Complete	¼	7/16	7/16-20	SAE 37° (JIC)	5	89.9	(3.54)	-	-	-	-	-	-	-	
5410-S17-6-4*	Male	¼	9/16	9/16-18	SAE 37° (JIC)	3	48.0	(1.89)	21.1	(.83)	19	(.75)	-	-	16.0	(.63)
5410-S14-6-4*	Female	¼	9/16	9/16-18	SAE 37° (JIC)	4	49.3	(1.94)	21.1	(.83)	16.0	(.63)	19	(.75)	15.7	(.62)
5410-6-4*	Complete	¼	9/16	9/16-18	SAE 37° (JIC)	5	90.4	(3.56)	-	-	-	-	-	-	-	
5410-S17-6-8*	Male	¼	9/16	9/16-18	SAE 37° (JIC)	3	55.4	(2.18)	31.8	(1.25)	29	(1.14)	-	-	25.4	(1.00)
5410-S14-6-8*	Female	½	9/16	9/16-18	SAE 37° (JIC)	4	61.7	(2.43)	33.3	(1.31)	26	(1.02)	30	(1.18)	25.4	(1.00)
5410-6-8*	Complete	½	9/16	9/16-18	SAE 37° (JIC)	5	107.4	(4.23)	-	-	-	-	-	-	-	
5410-S17-8-8*	Male	½	¾	¾-16	SAE 37° (JIC)	3	57.9	(2.28)	31.8	(1.25)	29	(1.14)	-	-	25.4	(1.00)
5410-S14-8-8*	Female	½	¾	¾-16	SAE 37° (JIC)	4	64.3	(2.53)	33.3	(1.31)	26	(1.02)	30	(1.18)	25.4	(1.00)
5410-8-8*	Complete	½	¾	¾-16	SAE 37° (JIC)	5	112.8	(4.44)	-	-	-	-	-	-	-	
5410-S17-10-12*	Male	¾	7/8	7/8-14	SAE 37° (JIC)	3	69.9	(2.75)	46.5	(1.83)	41	(1.62)	-	-	35.1	(1.38)
5410-S14-10-12*	Female	¾	7/8	7/8-14	SAE 37° (JIC)	4	80.3	(3.16)	45.7	(1.80)	35	(1.38)	41	(1.62)	35.1	(1.38)
5410-10-12*	Complete	¾	7/8	7/8-14	SAE 37° (JIC)	5	135.4	(5.33)	-	-	-	-	-	-	-	
5410-S17-12-12*	Male	¾	1 1/16	1 1/16-12	SAE 37° (JIC)	3	72.6	(2.86)	46.5	(1.83)	41	(1.62)	-	-	35.1	(1.38)
5410-S14-12-12*	Female	¾	1 1/16	1 1/16-12	SAE 37° (JIC)	4	83.1	(3.27)	45.7	(1.80)	35	(1.38)	41	(1.62)	35.1	(1.38)
5410-12-12*	Complete	¾	1 1/16	1 1/16-12	SAE 37° (JIC)	5	140.7	(5.54)	-	-	-	-	-	-	-	
5410-S17-16-16*	Male	1	1 5/16	1 5/16-12	SAE 37° (JIC)	3	75.9	(2.99)	53.3	(2.10)	48	(1.89)	-	-	44.5	(1.75)
5410-S14-16-16*	Female	1	1 5/16	1 5/16-12	SAE 37° (JIC)	4	89.7	(3.53)	56.9	(2.24)	45	(1.77)	50	(1.97)	44.5	(1.75)
5410-16-16*	Complete	1	1 5/16	1 5/16-12	SAE 37° (JIC)	5	149.6	(5.89)	-	-	-	-	-	-	-	

Above items must be ordered at the component level - see page 148.

DIAGNOSTIC

AGRICULTURE

5400 Series Low Air Inclusion Refrigerant

Dimensions – Braze Tubing Adapter (Dimensional reference only)

Part Number Neoprene	Coupling Type	Body Size	Tube O.D. Size	Type	Fig.	Dimensions									
						A		B		Hex ①		Hex ②		Hex ③	
*Couplings must be ordered by components as shown on page 147.						mm	(in)	mm	(in)	mm	(in)	mm	(in)	mm	(in)
5401-S17-4-4*	Male	¼	¼	Braze Tubing Adapter	6	38.6	(1.52)	21.1	(.83)	19	(.75)	-	-	16.0	(.63)
5401-S14-4-4*	Female	¼	¼	Braze Tubing Adapter	7	39.9	(1.57)	21.1	(.83)	16.0	(.63)	19	(.75)	16.0	(.63)
5401-S17-6-4*	Male	¼	¾	Braze Tubing Adapter	6	38.6	(1.52)	21.1	(.83)	19	(.75)	-	-	16.0	(.63)
5401-S14-6-4*	Female	¼	¾	Braze Tubing Adapter	7	39.9	(1.57)	21.1	(.83)	16.0	(.63)	19	(.75)	16.0	(.63)
5410-S17-6-8*	Male	½	¾	Braze Tubing Adapter	6	44.5	(1.75)	33.3	(1.31)	29	(1.14)	-	-	25.4	(1.00)
5401-S14-6-8*	Female	½	¾	Braze Tubing Adapter	7	50.8	(2.00)	33.3	(1.31)	26	(1.02)	30	(1.18)	25.4	(1.00)
5401-S17-8-8*	Male	½	½	Braze Tubing Adapter	6	44.5	(1.75)	33.3	(1.31)	29	(1.14)	-	-	25.4	(1.00)
5401-S14-8-8*	Female	½	½	Braze Tubing Adapter	7	50.8	(2.00)	33.3	(1.31)	26	(1.02)	30	(1.18)	25.4	(1.00)
5401-S17-10-12*	Male	¾	⅝	Braze Tubing Adapter	6	62.7	(2.47)	45.7	(1.80)	41	(1.62)	-	-	35.1	(1.38)
5401-S14-10-12*	Female	¾	⅝	Braze Tubing Adapter	7	73.2	(2.88)	45.7	(1.80)	35	(1.38)	41	(1.62)	35.1	(1.38)
5401-S17-12-12*	Male	¾	¾	Braze Tubing Adapter	6	62.7	(2.47)	45.7	(1.80)	41	(1.62)	-	-	35.1	(1.38)
5401-S14-12-12*	Female	¾	¾	Braze Tubing Adapter	7	73.2	(2.88)	45.7	(1.80)	35	(1.38)	41	(1.62)	35.1	(1.38)
5401-S17-16-16*	Male	1	1	Braze Tubing Adapter	6	71.1	(2.80)	56.9	(2.24)	48	(1.89)	-	-	44.5	(1.75)
5401-S14-16-16*	Female	1	1	Braze Tubing Adapter	7	84.8	(3.34)	56.9	(2.24)	45	(1.77)	50	(1.97)	44.5	(1.75)

Dust Caps and Dust Plugs

Dust Cap with Gasket	Dust Plug with Gasket	Body Size
5400-S6-4	5400-S8-4	¼
5400-S6-8	5400-S8-8	½
5400-S6-12	5400-S8-12	¾
5400-S6-16	5400-S8-16	1

Adapter SAE 37° (JIC)

O-Ring	Brass	Steel	Body Size	Thread	Tube O.D. Size
22546-12	202220-4-4B	202220-4-4S	¼	7/16-20	¼
22546-12	202220-6-4B	202220-6-4S	¼	9/16-18	¾
22546-17	-	202220-6-8S	½	9/16-18	¾
22546-17	202220-8-8B	202220-8-8S	½	¾-16	½
22546-23	-	202220-10-12S	¾	7/8-14	⅝
22546-23	-	202220-12-12S	¾	1 1/16-12	¾
22546-28	-	202220-16-16S	¾	1 3/16-12	1

Adapter – Braze

O-Ring	Brass	Steel	Body Size	Thread	Tube O.D. Size
22546-12	202208-4-4B	-	¼	½-20	¼
22546-17	202208-4-8B	-	½	7/8-20	¼
22546-12	202208-6-4B	-	¼	½-20	¾
22546-17	202208-6-8B	-	½	7/8-20	¾
22546-17	202208-8-8B	-	½	7/8-20	½
22546-17	202208-10-8B	202208-10-8S	½	7/8-20	⅝
22546-23	202208-10-12B	202208-10-12S	¾	1 ¼-18	⅝
22546-23	202208-12-12B	-	¾	1 ¼-18	¾
22546-23	202208-14-12B	-	¾	1 ¼-18	7/8
22546-28	202208-14-16B	-	1	1 19/32-20	7/8
22546-28	202208-16-16B	-	1	1 19/32-20	1
22546-28	202208-18-16B	-	1	1 19/32-20	1 ⅛
22546-28	202208-20-16B	-	1	1 19/32-20	1 3/16
22546-28	202208-22-16B	-	1	1 19/32-20	1 ¼

Hose Fitting SAE 100R5†

O-Ring	Fitting Assembly	Body Size	Hose Size	Thread	Dimensions D	
					mm	(in)
22546-12	487-4-4S	¼	-4	½-20	23.4	(.92)
22546-12	487-4-6S	¼	-6	½-20	24.4	(.96)
22546-17	487-8-6S	½	-6	7/8-20	24.4	(.96)
22546-17	487-8-8S	½	-8	7/8-20	26.9	(1.06)
22546-23	487-12-10S	¾	-10	1 ¼-18	27.2	(1.07)
22546-23	487-12-12S	¾	-12	1 ¼-18	27.2	(1.07)
22546-28	487-16-16S	1	-16	1 19/32-20	25.7	(1.01)

†Additional dash styles available.

Dust Cap Dust Plug



Adapter SAE 37° (JIC)

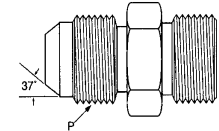

Adapter – Braze
(O-Ring Required)

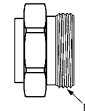

Hose Fitting SAE 100R5
(O-Ring Required)

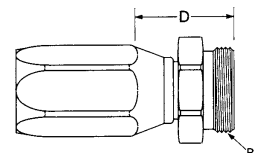

FLUID TRANSFER
AND HYDRAULIC

PNEUMATIC

SPECIAL APPLICATIONS

DIAGNOSTIC

AGRICULTURE

REFRIGERANT

5400 Series

Low Air Inclusion Refrigerant

For assemblies, order by components as shown by base number and dash (-) size below. Example, if a 5401-S14-10-12 is required, order as components, (1) 5400-S5-12, (1) 202208-10-12B Adapter and (1) 22546-23 O-Ring.

Assembly Part Number	5400-S2 Male Half	Quantity	5400-S5 Female Half	Quantity	202208-Brass Braze-On Adapter	Quantity	202220-Steel 37° SAE Adapter	Quantity	22546 O-Ring	Quantity
5401-S14-10-12			-12	1	-10 -12B	1			-23	1
5401-S14-10-8			-8	1	-10 -8B				-17	1
5401-S14-12-12			-12	1	-12 -12B	1			-23	1
5401-S14-16-16			-16	1	-16 -16B	1			-28	1
5401-S14-4-4			-4	1	-4 -4B	1			-12	1
5401-S14-6-4			-4	1	-6 -4B	1			-12	1
5401-S14-6-8			-8	1	-6 -8B	1			-17	1
5401-S14-8-8			-8	1	-8 -8B	1			-17	1
5401-S17-10-12	-12	1			-10 -12B	1			-23	1
5401-S17-10-8	-8	1			-10 -8B	1			-17	1
5401-S17-12-12	-12	1			-12 -12	1			-23	1
5401-S17-14-16	-16	1			-16 -16	1			-28	1
5401-S17-4-4	-4	1			-4 -4B	1			-17	1
5401-S17-6-4	-4	1			-6 -4B	1			-12	1
5401-S17-6-8	-8	1			-6 -8B	1			-17	1
5401-S17-8-8	-8	1			-8 -8B	1			-17	1
5410-12-12	-12	1	-12	1			-12 -12S	2	-23	2
5410-16-16	-16	1	-16	1			-16 -16S	2	-28	2
5410-4-4	-4	1	-4	1			-4 -4S	2	-12	2
5410-6-8	-8	1	-8	1			-6 -8S	2	-17	2
5410-8-8	-8	1	-8	1			-8 -8S	2	-17	2
5410-S14-10-12			-12	1			-10 -12S	1	-23	1
5410-S14-12-12			-12	1			-12 -12S	1	-23	1
5410-S14-16-16			-16	1			-16 -16S	1	-28	1
5410-S14-4-4			-4	1			-4 -4S	1	-12	1
5410-S14-6-4			-4	1			-6 -4S	1	-12	1
5410-S14-6-8			-8	1			-6 -8S	1	-17	1
5410-S14-8-8			-8	1			-8 -8S	1	-17	1
5410-S17-10-12	-12	1					-10 -12S	1	-23	1
5410-S17-12-12	-12	1					-12 -12S	1	-23	1
5410-S17-16-16	-16	1					-16 -16S	1	-28	1
5410-S17-4-4	-4	1					-4 -4S	1	-12	1
5410-S17-6-4	-4	1					-6 -4S	1	-12	1
5410-S17-6-8	-8	1					-6 -8S	1	-17	1
5410-S17-8-8	-8	1					-8 -8S	1	-17	1

FLUID TRANSFER AND HYDRAULIC

PNEUMATIC

SPECIAL APPLICATIONS

DIAGNOSTIC

AGRICULTURE

REFRIGERANT

5400 Series Low Air Inclusion Refrigerant

Assembly Instructions/Component Part Numbers

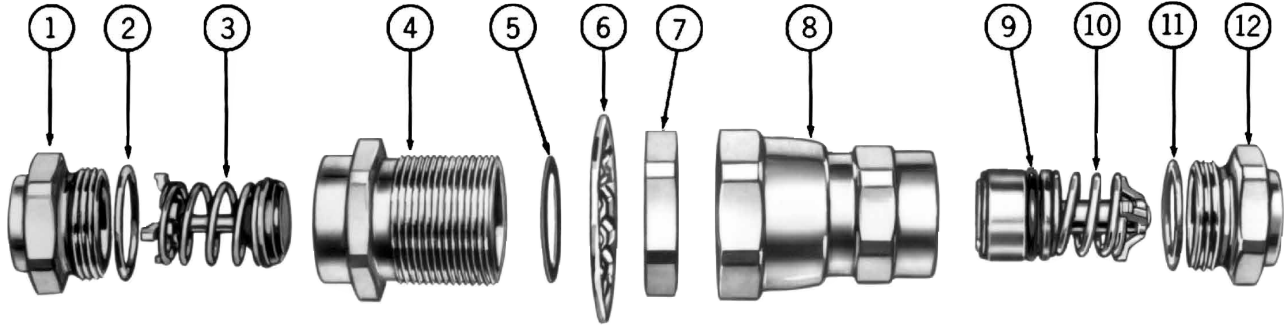

Typical Male Coupling Half (S2)

Assembly Instructions

Steps:

- After tubing or hose has been connected to adapters ① and ②, install O-Rings ③ and ④ on adapters. Be sure O-Rings are not twisted.
- Oil O-Rings ③ and ④ liberally with system fluid to prevent them from scuffing and tearing when coupling body is threaded on adapter.
- S2 Half—Lubricate poppet face with system fluid. Insert poppet valve assembly ③ into body ④. Tighten body ④ on adapter ①. After body and adapter make metal-to-metal contact, tighten by rotating body ④ 1/8" with respect to adapter ① or torque per table value.

S5 Half—Oil O-Ring ⑤ liberally with system fluid. Insert valve and sleeve assembly 10 into body ⑥. Tighten body ⑥ on adapter ②. After body and adapter make metal-to-metal contact, tighten by rotating body ⑥ 1/8" with respect to adapter ② or torque per table value.

- Coupling Connection—Lubricate gasket seal ⑤ on 5400-S2 half with system fluid. Thread union nut ⑦ on 5400-S2 half. Tighten union nut to torque values shown in table. Be sure S2 and S5 bodies do not rotate during connection.

Typical Female Coupling Half (S5)

Bulkhead Mounting—S2 Half

Install lock washer ⑥ on S2 half. Insert S2 half through bulkhead, and tighten jam nut ⑦ so that lock washer teeth are fully compressed.

NOTE: Lock washer 6 must be between hex of S2 half and bulkhead.

Maximum Bulkhead Thickness

Body Size	Lock Washer Installed	Lock Washer Not Used
1/4	.206	.256
1/2	.136	.203
3/4	.232	.292
1	.101	.161

Torque Values

Recommended torque values in ft. lbs., are listed below.

Dash Size	Adapter to Body		
	Braze Type or Aluminum	Non-braze Type Steel or Brass	S2 Half to S5 Half
-4	6-8	12-15	10-12
-8	15-20	35-45	35-37
-12	35-40	45-55	45-47
-16	50-60	55-65	65-67

IMPORTANT: Generous lubrication is required for all gaskets and O-Rings. Use refrigeration oil only when used in refrigerant system.

Component Part Numbers

Item Number	Dash Size O.D. Tube Size	-4 1/4"-3/8"	-8 1/4"-5/8"	-12 5/8"-7/8"	-16 7/8"-13/8"	Line Ref.
Typical Male Half						
1	Tubing Adapter	202208-* -4	202208-* -8	202208-* -12	202208-* -16	2
2	O-Ring	22546-12	22546-17	22546-23	22546-28	3
3	Poppet Valve Assembly	5400-S20-4	5400-S20-8	5400-S20-12	5400-S20-16	4
4	Body	5400-17-4S	5400-17-8S	5400-17-12S	5400-17-16S	5
5	Gasket Seal	22008-4	22008-8	22008-12	22008-16	6
6	Lock Washer	5400-54-4S	5400-54-8S	5400-54-12S	5400-54-16S	7
7	Jam Nut	5400-53-4S	5400-53-8S	5400-53-12S	5400-53-16S	8
Typical Female Half						
8	Union Nut and Body Assembly	5400-S16-4	5400-S16-8	5400-S16-12	5400-S16-16	10
9	O-Ring	FF91178-10	FF91178-112	FF91178-116	FF91178-214	11
10	Valve and Sleeve Assembly	5400-S19-4	5400-S19-8	5400-S19-12	5400-S19-16	12
11	O-Ring	22546-12	22546-17	22546-23	22546-28	13
12	Tubing Adapter	202208-* -4	202208-* -8	202208-* -12	202208-* -16	14

*Specify O.D. Tubing size of adapter required in 16th of an inch. Example: -4 coupling with 3/8" O.D. tubing is 6/16 or -6. Part number is then 202208-6-4.

FLUID TRANSFER
AND HYDRAULIC

PNEUMATIC

SPECIAL APPLICATIONS

DIAGNOSTIC

AGRICULTURE

REFRIGERANT

Part Number Index

Part Number	Page Number	Part Number	Page Number
10	75, 85, 90	10FFS56ORM	35
11	75, 85, 90	10FFS56UN	34
13	85	10FFS75ORM	35
14	85	10FFS75UN	34
16	86	10FFS87UN	34
17	86	10FFS8L	35
900	85	10G	87
1100	85	10H41	9
1200	85	10H41BS	9
1300	85	10K41	10
1800	86	10K41BS	10
2254617	147	10NK	85
1000E	85	10S41	118
10C	85	10S41BS	118
10FFP10L	37	10T40	117
10FFP12L	37	10T41	118
10FFP15L	37	11B	85
10FFP15LBH	37	11G	85
10FFP16FMET	36	11NK	85
10FFP16S	37	12E	85
10FFP37	36	12FFP106UN	36
10FFP37BS	36	12FFP15LBH	37
10FFP37FG	36	12FFP16S	37
10FFP50	36	12FFP18LBH	37
10FFP50BS	36	12FFP50	36
10FFP50FG	36	12FFP50BS	36
10FFP56ORM	37	12FFP50FG	36
10FFP56UN	36	12FFP75	36
10FFP75ORM	37	12FFP75BS	36
10FFP75UN	36	12FFP75FG	36
10FFP87UN	36	12FFP75UN	36
10FFP8L	37	12FFP87UN	36
10FFPCUP37	41	12FFPCUP50	41
10FFPCUP37BS	41	12FFPCUP50BS	41
10FFPCUP50	41	12FFPCUP56UN	41
10FFPCUP50BS	41	12FFPCUP75UN	41
10FFS10L	35	12FFS106UN	34
10FFS12L	35	12FFS15LBH	35
10FFS15L	35	12FFS16S	35
10FFS15LBH	35	12FFS18LBH	35
10FFS16FMET	34	12FFS50	34
10FFS16S	35	12FFS50BS	34
10FFS37	34	12FFS50FG	34
10FFS37BS	34	12FFS75	34
10FFS37FG	34	12FFS75BS	34
10FFS50	34	12FFS75FG	34
10FFS50BS	34	12FFS75UN	34
10FFS50FG	34	12FFS87UN	34

Part Number Index

Part Number	Page Number	Part Number	Page Number
12G	87	12S46BS	118
12H41	9	12T45	117
12H41BS	9	12T46	118
12H46	9	14G	85
12H46BS	9	150-22-12	51
12IAP10L	23	150-22-16	51
12IAP10LBH	23	150-22-20	51
12IAP12L	23	150-22-5	51
12IAP12LBH	23	150-22-8	51
12IAP12S	23	15E	85
12IAP15L	23	1600E	86
12IAP15LBH	23	1600P	86
12IAP16FMET	23	16FFP106UN	36
12IAP16S	23	16FFP15LBH	37
12IAP37	23	16FFP16S	37
12IAP37BS	23	16FFP18LBH	37
12IAP50	23	16FFP50	36
12IAP50BS	23	16FFP50BS	36
12IAP56ORM	23	16FFP75	36
12IAP56UN	23	16FFP75BS	36
12IAP75ORM	23	16FFP75FG	36
12IAP75UN	23	16FFP75UN	36
12IAP87UN	23	16FFP87UN	36
12IAP8L	23	16FFS106UN	34
12IAS10L	22	16FFS15LBH	35
12IAS10LBH	22	16FFS16S	35
12IAS12L	22	16FFS18LBH	35
12IAS12LBH	22	16FFS50	34
12IAS12S	22	16FFS50BS	34
12IAS15L	22	16FFS75	34
12IAS15LBH	22	16FFS75BS	34
12IAS16FMET	22	16FFS75FG	34
12IAS16S	22	16FFS75UN	34
12IAS37	22	16FFS87UN	34
12IAS37BS	22	16G	86
12IAS50	22	16NK	86
12IAS50BS	22	16P	86
12IAS56ORM	22	16S51	118
12IAS56UN	22	16S51BS	118
12IAS75ORM	22	16T50	117
12IAS75UN	22	16T51	118
12IAS87UN	22	1700E	86
12IAS8L	22	1700P	86
12K41	10	17G	86
12K41BS	10	17NK	86
12K46	10	17P	86
12K46BS	10	18E	86
12S46	118	19FFP100	36

Part Number Index

Part Number	Page Number	Part Number	Page Number
19FFP100BS	36	202208-10-8S	143
19FFP100FG	36	202208-12-12B	143
19FFP106UN	36	202208-14-12B	143
19FFP131UN	36	202208-14-16B	143
19FFP75	36	202208-16-16B	143
19FFP75BS	36	202208-18-16B	143
19FFS100	34	202208-20-16B	143
19FFS100BS	34	202208-22-16B	143
19FFS100FG	34	202208-4-4B	143
19FFS106UN	34	202208-4-8B	143
19FFS131UN	34	202208-6-4B	143
19FFS75	34	202208-6-8B	143
19FFS75BS	34	202208-8-8B	143
1H11	9	202220-10-12S	143
1H4	9	202220-12-12S	143
1K11	10	202220-16-16S	143
1K4	10	202220-4-4B	143
1S10	117	202220-4-4S	143
1S10BS	117	202220-6-4B	143
1S11	118	202220-6-4S	143
1S11BS	118	202220-6-8S	143
1S12	119	202220-8-8B	143
1S17	119	202220-8-8S	143
1SB1	87	20H51	9
1SB3	87	20H51BS	9
1SB5E	87	20H56	9
1SB7	87	20H56BS	9
1SC5	87	20H61	9
1SC7	87	20H61BS	9
1SC9	87	20K51	10
1SD11	87	20K51BS	10
1SD5	87	20K56	10
1SD7	87	20K56BS	10
1SD9	87	20K61	10
1T10E	117	20K61BS	10
1T11	118	20S56	118
1T15	117	20T56	118
202208-*--12	145	22008-12	145
202208-*--12	145	22008-16	145
202208-*--16	145	22008-4	145
202208-*--16	145	22008-8	145
202208-*--4	145	22546-12	143, 145
202208-*--4	145	22546-17	143, 145
202208-*--8	145	22546-23	143, 145
202208-*--8	145	22546-28	143, 145
202208-10-12B	143	25FFP100	36
202208-10-12S	143	25FFP100BS	36
202208-10-8B	143	25FFP125	36

Part Number Index

Part Number	Page Number	Part Number	Page Number
25FFP125BS	36	2HIL15	115
25FFP125FG	36	2HIL16	115
25FFP131UN	36	2HIL20	115
25FFP162UN	36	2HIL720	115
32FFP125	36	2HILLRA720	115
32FFP162UN	36	2K16	10
40FFP150	36	2K16BS	10
40FFP150BS	36	2K6	10
40FFP187UN	36	2KIGF	114
50FFP200	36	2KIGF15	114
50FFP200BS	36	2KIGF16	114
50FFP250UN	36	2KIGF20	114
32FFS125	34	2KIGF720	114
25FFS100	34	2KILF	115
25FFS100BS	34	2KILF15	115
25FFS125	34	2KILF16	115
25FFS125BS	34	2KILF20	115
25FFS125FG	34	2KILF720	115
25FFS131UN	34	2S15	117
25FFS162UN	34	2S16	118
32FFS125BS	34	2S16BS	118
32FFS162UN	34	2S17	119
40FFS150	39	2T15	117
40FFS150BS	39	2T16	118
40FFS187UN	34	2UHP25	36
50FFS200	39	2UHP25BS	36
50FFS200BS	39	2UHS25	36
50FFS250UN	34	2UHS25BS	36
2DBPG143	45	3H21	9
2DBPG242	45	3H21BS	9
2DBPG292	45	3H8	9
2DBPG503	45	3K21	10
2DBSG143	45	3K21BS	10
2DBSG242	45	3K8	10
2DBSG292	45	3PB1	87
2DBSG503	45	3PB11	87
2H16	9	3PB3	87
2H16BS	9	3PB5	87
2H6	9	3PB7	87
2HIG10	114	3PB9	87
2HIG11	114	3PC5	87
2HIG15	114	3PC7	87
2HIG16	114	3PC9	87
2HIG20	114	3PD11	87
2HIG720	114	3PD5	87
2HIGLLRA720	114	3PD7	87
2HIL10	115	3PD9	87
2HIL11	115	3S20	117

Part Number Index

Part Number	Page Number	Part Number	Page Number
3S20BS	117	5100-S2-4B	49
3S21	118	5100-S2-6B	49
3S21BS	118	5100-S2-8B	49
3S22	119	5100-S4-10B	50
3T20	117	5100-S4-12B	50
3T21	118	5100-S4-16B	50
487-12-10S	143	5100-S4-20B	50
487-12-12S	143	5100-S4-24B	50
487-16-16S	143	5100-S4-4B	50
487-4-4S	143	5100-S4-6B	50
487-4-6S	143	5100-S4-8B	50
487-8-6S	143	5100-S5-10B	50
487-8-8S	143	5100-S5-12B	50
4DBPG143	45	5100-S5-16B	50
4DBPG242	45	5100-S5-20B	50
4DBPG292	45	5100-S5-24B	50
4DBPG503	45	5100-S5-4B	50
4DBSG143	45	5100-S5-6B	50
4DBSG242	45	5100-S5-8B	50
4DBSG292	45	5100-S7-12	51
4DBSG503	45	5100-S7-16	51
4HP10	9	5100-S7-20	51
4HP26	9	5100-S7-24	51
4HP26BS	9	5100-S7-5	51
4KP10	10	5100-S7-8	51
4KP26	10	5100-S9-12	51
4KP26BS	10	5100-S9-16	51
4S25	117	5100-S9-20	51
4S25BS	117	5100-S9-24	51
4S26	118	5100-S9-5	51
4S26BS	118	5100-S9-8	51
4S27	119	5101-10B	50
4T25	117	5101-12B	50
4T26	118	5101-16B	50
5100-10B	51	5101-20B	50
5100-12B	51	5101-24B	50
5100-16B	51	5101-4B	50
5100-20B	51	5101-6B	50
5100-22-245	51	5101-8B	50
5100-24B	51	5110-10B	50
5100-4B	51	5110-12B	50
5100-6B	51	5110-20B	50
5100-8B	51	5110-4B	50
5100-S2-10B	49	5110-6B	50
5100-S2-12B	49	5110-8B	50
5100-S2-16B	49	5110-S5-10B	49
5100-S2-20B	49	5110-S5-12B	49
5100-S2-24B	49	5110-S5-16B	49

Part Number Index

Part Number	Page Number	Part Number	Page Number
5110-S5-20B	49	5400-S6-8	143
5110-S5-24B	49	5400-S8-12	143
5110-S5-4B	49	5400-S8-16	143
5110-S5-6B	49	5400-S8-4	143
5110-S5-8B	49	5400-S8-8	143
5111-10B	49	5401-S14-10-12	143, 144
5111-12B	49	5401-S14-10-8	144
5111-16B	49	5401-S14-12-12	143, 144
5111-20B	49	5401-S14-16-16	143, 144
5111-24B	49	5401-S14-4-4	143, 144
5111-4B	49	5401-S14-6-4	143, 144
5111-6B	49	5401-S14-6-8	143, 144
5111-8B	49	5401-S14-8-8	143, 144
5400-17-12S	145	5401-S17-10-12	143, 144
5400-17-16S	145	5401-S17-10-8	144
5400-17-4S	145	5401-S17-12-12	143, 144
5400-17-8S	145	5401-S17-14-16	144
5400-53-12S	145	5401-S17-16-16	143
5400-53-16S	145	5401-S17-4-4	143, 144
5400-53-4S	145	5401-S17-6-4	143, 144
5400-53-8S	145	5401-S17-6-8	144
5400-54-12S	145	5401-S17-8-8	143, 144
5400-54-16S	145	5410-10-12	142
5400-54-4S	145	5410-12-12	142, 144
5400-54-8S	145	5410-16-16	142, 144
5400-S16-12	145	5410-4-4	142, 144
5400-S16-16	145	5410-6-4	142
5400-S16-4	145	5410-6-8	142, 144
5400-S16-8	145	5410-8-8	142, 144
5400-S19-12	145	5410-S14-10-12	142, 144
5400-S19-16	145	5410-S14-12-12	142, 144
5400-S19-4	145	5410-S14-16-16	142, 144
5400-S19-8	145	5410-S14-4-4	142, 144
5400-S20-12	145	5410-S14-6-4	142, 144
5400-S20-16	145	5410-S14-6-8	142, 144
5400-S20-4	145	5410-S14-8-8	142, 144
5400-S20-8	145	5410-S17-10-12	142, 144
5400-S2-12	142	5410-S17-12-12	142, 144
5400-S2-16	142	5410-S17-16-16	142, 144
5400-S2-4	142	5410-S17-4-4	142, 144
5400-S2-8	142	5410-S17-6-4	142, 144
5400-S5-12	142	5410-S17-6-8	142, 143, 144
5400-S5-16	142	5410-S17-8-8	142, 144
5400-S5-4	142	560024-12-12	20
5400-S5-8	142	560024-16-16	20
5400-S6-12	143	560024-8-10	20
5400-S6-16	143	560049-12-12	20
5400-S6-4	143	560049-16-16	20

Part Number Index

Part Number	Page Number	Part Number	Page Number
560049-8-10	20	8S35BS	117
6DBPG143	45	8S36	118
6DBPG242	45	8S36BS	118
6DBPG292	45	8S37	119
6DBPG503	45	8T35	117
6DBSG143	45	8T36	118
6DBSG242	45	8T37	119
6DBSG292	45	B10	85
6DBSG503	45	B10H41	12
6FFP10LBH	37	B10T40	117
6FFP25	36	B10T40BS	117
6FFP25BS	36	B10T41	118
6FFP25FG	36	B10T41BS	118
6FFP56UN	36	B12H41	12
6FFS10LBH	35	B12H41BS	12
6FFS25	34	B12H46	12
6FFS25BS	34	B12H46BS	12
6FFS25FG	34	B12T45	117
6FFS56UN	34	B12T45BS	117
6HP12	9	B12T46	118
6HP31	9	B12T46BS	118
6HP31BS	9	B16T50	117
6KP12	10	B16T51	118
6KP31	10	B16T51BS	118
6KP31BS	10	B17	86
6S30	117	B1H11	12
6S30BS	117	B1T10	117
6S31	118	B1T11	118
6S31BS	119	B1T11BS	118
6S32	119	B1T12	119
6T30	117	B1T15	117
6T31	118	B1T17	119
800E	85	B20H51	12
8DBPG143	45	B20H51BS	12
8DBPG242	45	B20H56	12
8DBPG292	45	B20H56BS	12
8DBPG503	45	B20H61	12
8DBSG143	45	B20H61BS	12
8DBSG242	45	B20T55	117
8DBSG292	45	B20T56	118
8DBSG503	45	B2H16	12
8HP16	9	B2H16BS	12
8HP36	9	B2T15	117
8HP36BS	9	B2T15BS	117
8KP16	10	B2T16	118
8KP36	10	B2T16BS	118
8KP36BS	10	B2T17	119
8S35	117	B3H21	12

Part Number Index

Part Number	Page Number	Part Number	Page Number
B3H21BS	12	CR16FFPYL	37, 39, 41, 45, 47
B3T20	117	CR16FFSDG	37, 39, 41, 45, 47
B3T20BS	117	CR16FFSLB	37, 39, 41, 45, 47
B3T21	118	CR16FFSP93	37, 39, 41, 45, 47
B3T21BS	118	CR16FFSRD	37, 39, 41, 45, 47
B3T22	119	CR16FFSYL	37, 39, 41, 45, 47
B4HP26	12	CR19FFPDG	37, 39, 41, 45, 47
B4HP26BS	12	CR19FFPLB	37, 39, 41, 45, 47
B4T25	117	CR19FFPRD	37, 39, 41, 45, 47
B4T25BS	117	CR19FFPYL	37, 39, 41, 45, 47
B4T26	118	CR19FFSDG	37, 39, 41, 45, 47
B4T26BS	118	CR19FFSLB	37, 39, 41, 45, 47
B4T27	119	CR19FFSP93	37, 39, 41, 45, 47
B6HP31	12	CR19FFSRD	37, 39, 41, 45, 47
B6HP31BS	12	CR19FFSYL	37, 39, 41, 45, 47
B6T30	117	CR4DBSP93	37, 39, 41, 45, 47
B6T30BS	117	CRKIT10FF	37, 39, 41, 45, 47
B6T31	118	CRKIT12FF	37, 39, 41, 45, 47
B6T31BS	118	CRKIT16FF	37, 39, 41, 45, 47
B6T32	119	CRKIT19FF	37, 39, 41, 45, 47
B8HP36	12	CRKIT4DB	37, 39, 41, 45, 47
B8HP36BS	12	EA0070278	106
B8T35	117	EA0070289	106
B8T35BS	117	EA0070290	106
B8T36	118	EA0070401	106
B8T36BS	118	EA0070411	106
B8T37	119	EA0070412	106
CR10FFPDG	37, 39, 41, 45, 47	EA0070413	106
CR10FFPLB	37, 39, 41, 45, 47	EA0070467	106
CR10FFPRD	37, 39, 41, 45, 47	EA0070478	106
CR10FFPYL	37, 39, 41, 45, 47	EA0070489	106
CR10FFSDG	37, 39, 41, 45, 47	EA0070490	106
CR10FFSLB	37, 39, 41, 45, 47	EA0070601	106
CR10FFSP93	37, 39, 41, 45, 47	EA0070611	106
CR10FFSRD	37, 39, 41, 45, 47	EA0070612	106
CR10FFSYL	37, 39, 41, 45, 47	EA0070613	106
CR12FFPDG	37, 39, 41, 45, 47	EA0070616	106
CR12FFPLB	37, 39, 41, 45, 47	EA0070678	106
CR12FFPRD	37, 39, 41, 45, 47	EA0070689	106
CR12FFPYL	37, 39, 41, 45, 47	EA0070690	106
CR12FFSDG	37, 39, 41, 45, 47	EA0070811	106
CR12FFSLB	37, 39, 41, 45, 47	EA0070812	106
CR12FFSP93	37, 39, 41, 45, 47	EA0070813	106
CR12FFSRD	37, 39, 41, 45, 47	EA0070816	106
CR12FFSYL	37, 39, 41, 45, 47	EA0070819	106
CR16FFPDG	37, 39, 41, 45, 47	EA0070889	106
CR16FFPLB	37, 39, 41, 45, 47	EA0071016	106
CR16FFPRD	37, 39, 41, 45, 47	EA0071019	106

Part Number Index

Part Number	Page Number	Part Number	Page Number
EA0071025	106	FD49-1057-08-06	43
EA0072019	106	FD56-1001-08-10	20
EA0072025	106	FD56-1001-12-12	20
EA0072030	106	FD56-1001-16-16	20
EA0078167	107	FD69-1000-060806	111
EA0078178	107	FD69-1000-060808	111
EA0078189	107	FD69-1000-080806	111
EA0078190	107	FD69-1000-080808	111
EA0079701	107	FD69-1001-06-08	111
EA0079712	107	FD69-1001-08-08	111
EA0079716	107	FD69-1002-06-08	111
EA0079719	107	FD69-1002-08-08	111
EA0079767	107	FD69-1002-08-08	111
EA0079778	107	FD69-1002-08-08	111
EA0079789	107	FD69-1010-080808	111
EA0079790	107	FD69-1011-08-08	111
EL0070267	106	FD69-1012-08-08	111
ENRTPU081210E	108	FD69-1026-06-08	111
FD15-1000-02	136	FD69-1026-08-08	111
FD15-1000-04	136	FD69-1027-060806	111
FD15-1002-04	136	FD69-1027-060808	111
FD15-1025-04	136	FD69-1027-080806	111
FD15-1026-04	136	FD69-1027-080808	111
FD17-1003-04-04	109	FD69-1028-06-08	111
FD17-1062-04	109	FD69-1028-08-08	111
FD17-1064-04	109	FD69-1029-060806	111
FD17-1082-10-04	109	FD69-1029-060808	111
FD35-1000-06-06	71	FD69-1029-080806	111
FD35-1001-06-06	71	FD69-1029-080808	111
FD35-1002-06-06	71	FD83-2046-16-16	112
FD35-1006-06-06	71	FD83-2052-12-16	112
FD35-1007-06-06	71	FD83-2052-16-16	112
FD35-1008-06-06	71	FD85-1000-12-12	53
FD35-1042-06	71	FD85-1000-16-16	53
FD35-1052-06-06	71	FD85-1000-20-20	53
FD48-1001-04-04	141	FD85-1000-24-24	53
FD48-1002-04-04	141	FD85-1000-32-32	53
FD48-1042-04	141	FD85-1001-12-12	53
FD49-1001-06-06	43	FD85-1001-16-16	53
FD49-1001-08-06	43	FD85-1001-20-20	53
FD49-1002-06-06	43	FD85-1001-24-24	53
FD49-1002-08-06	43	FD85-1001-32-32	53
FD49-1004-08-06	43	FD85-1003-12-12	53
FD49-1005-08-06	43	FD85-1003-16-16	53
FD49-1014-06-06	43	FD85-1003-20-20	53
FD49-1014-08-06	43	FD85-1003-24-24	53
FD49-1042-06	43	FD85-1003-32-32	53
FD49-1057-06-06	43	FD85-1016-12-12	53

Part Number Index

Part Number	Page Number	Part Number	Page Number
FD85-1016-16-16	53	FD86-1052-16-16	55
FD85-1016-20-20	53	FD86-1052-20-20	55
FD85-1016-24-24	53	FD86-1053-16-16	55
FD85-1016-32-32	53	FD86-1053-20-20	55
FD85-1017-12-12	53	FD86-1054-16-16	55
FD85-1017-16-16	53	FD86-1054-20-20	55
FD85-1017-20-20	53	FD90-1004-03-04	137
FD85-1017-24-24	53	FD90-1004-04-04	137
FD85-1017-32-32	53	FD90-1004-05-04	137
FD85-1019-12-12	53	FD90-1004-06-04	137
FD85-1019-16-16	53	FD90-1012-02-04	137
FD85-1019-20-20	53	FD90-1012-04-04	137
FD85-1019-24-24	53	FD90-1021-02-04	137
FD85-1019-32-32	53	FD90-1021-04-04	137
FD86-1001-16-16	55	FD90-1034-02-04	137
FD86-1001-20-20	55	FD90-1034-04-04	137
FD86-1002-16-16	55	FD90-1035-02-04	137
FD86-1002-20-20	55	FD90-1035-04-04	137
FD86-1004-16-16	55	FD90-1040-04	138
FD86-1004-20-20	55	FD90-1041-04-04	138
FD86-1006-16-16	55	FD90-1044-03-04	137
FD86-1006-20-20	55	FD90-1044-04-04	137
FD86-1008-16-16	55	FD90-1044-05-04	137
FD86-1008-20-20	55	FD90-1044-06-04	137
FD86-1010-16-16	55	FD90-1045-02-04	137
FD86-1010-20-20	55	FD90-1045-04-04	137
FD86-1016-16	55	FD90-1046-06-04	138
FD86-1016-20	55	FD90-1047-06-04	138
FD86-1018-16	55	FD90-1061-04-04	138
FD86-1018-20	55	FD90-1061-06-04	138
FD86-1039-16-16	55	FD90-1061-08-04	138
FD86-1039-20-20	55	FD90-1090-10-04	138
FD86-1040-16-16	55	FD90-1206-04-04	138
FD86-1040-20-20	55	FD96-1001-06-06	43
FD86-1041-16-16	55	FD96-1001-08-06	43
FD86-1041-20-20	55	FD96-1001-08-08	43
FD86-1042-16-16	55	FD96-1001-12-08	43
FD86-1042-20-20	55	FD96-1001-12-12	43
FD86-1043-16-16	55	FD96-1001-12-16	43
FD86-1043-20-20	55	FD96-1001-16-16	43
FD86-1044-16-16	55	FD96-1001-16-20	43
FD86-1044-20-20	55	FD96-1001-20-20	43
FD86-1049-16-16	55	FD96-1001-20-24	43
FD86-1049-20-20	55	FD96-1001-24-24	43
FD86-1050-16-16	55	FD96-1001-32-32	43
FD86-1050-20-20	55	FD96-1002-06-06	43
FD86-1051-16-16	55	FD96-1002-08-06	43
FD86-1051-20-20	55	FD96-1002-08-08	43

Part Number Index

Part Number	Page Number	Part Number	Page Number
FD96-1002-12-08	43	FF098-08	51
FD96-1002-12-12	43	FF098-12	51
FD96-1002-12-16	43	FF098-16	51
FD96-1002-16-16	43	FF098-20	51
FD96-1002-16-20	43	FF098-24	51
FD96-1002-20-20	43	FF10166	111
FD96-1002-20-24	43	FF10593-16	55
FD96-1002-24-24	43	FF10593-20	55
FD96-1002-32-32	43	FF10594-16	55
FD96-1004-06-04	43	FF10594-20	55
FD96-1004-08-06	43	FF10595-16	55
FD96-1004-12-08	43	FF10595-20	55
FD96-1004-12-12	43	FF10596-16	55
FD96-1004-12-16	43	FF10596-20	55
FD96-1004-16-16	43	FF10597-16	55
FD96-1004-16-20	43	FF10597-20	55
FD96-1004-20-20	43	FF10598-16	55
FD96-1004-20-24	43	FF10598-20	55
FD96-1004-24-24	43	FF91178-10	145
FD96-1004-32-32	43	FF91178-112	145
FD96-1005-06-04	43	FF91178-116	145
FD96-1005-08-06	43	FF91178-214	145
FD96-1005-12-08	43	GA0066174	75, 90
FD96-1005-12-12	43	GA0066184	75, 90
FD96-1005-12-16	43	GA0066185	75, 90
FD96-1005-16-16	43	GA0066196	75, 90
FD96-1005-16-20	43	GA0066214	75, 90
FD96-1005-20-20	43	GA0066238	75, 90
FD96-1005-20-24	43	GA0066245	75, 90
FD96-1005-24-24	43	GA0066248	75, 90
FD96-1005-32-32	43	GA0066314	75, 90
FD96-1009-04	43	GA0066318	75, 90
FD96-1009-06	43	GA0066338	75, 90
FD96-1009-08	43	GA0066345	75, 90
FD96-1009-12	43	GA0066701	75, 90
FD96-1009-16	43	GA0066767	75, 90
FD96-1009-20	43	GA0066778	75, 90
FD96-1009-24	43	GA0066789	75, 90
FD96-1009-32	43	GA0066790	75, 90
FD96-1010-04	43	GA0066814	75, 90
FD96-1010-06	43	GA0066845	75, 90
FD96-1010-08	43	GA0076212	92
FD96-1010-12	43	GA0076214	92
FD96-1010-16	43	GA0076238	92
FD96-1010-20	43	GA0076312	92
FD96-1010-24	43	GA0076314	92
FD96-1010-32	43	GA0076338	92
FF098-04	51	GA0076701	92

Part Number Index

Part Number	Page Number	Part Number	Page Number
GA0076713	92	GD1853615	79
GA0076767	92	GD1853638	79
GA0076789	92	GD1853639	79
GA90090-12	61	GD1855014	79
GA90090-16	61	GD1855038	79
GA90090-8	61	GD1855601	79
GA90091-12	61	GD1855613	79
GA90091-16	61	GD1855667	79
GA90091-8	61	GD1855678	79
GA90092-12	61	GD1855689	79
GA90092-16	61	GD1855690	79
GA90092-8	61	GK1866214	79
GA90762-12	61	GK1866218	79
GA90762-8	61	GK1866238	79
GA90763-12	61	GK1866241	79
GA90763-8	61	GK1866245	79
GA90767-12-16	61	GK1866281	79
GA90767-16-20	61	GK1866314	79
GA90767-8	61	GK1866315	79
GA90768-12-16	61	GK1866318	79
GA90768-16-20	61	GK1866319	79
GA90768-8	61	GK1866338	79
GD1052612	74	GK1866339	79
GD1052614	74	GK1866341	79
GD1052621	74	GK1866381	79
GD1052638	74	GK1866701	79
GD1052641	74	GK1866713	79
GD1052683	74	GK1866767	79
GD1053612	74	GK1866778	79
GD1053613	74	GK1866789	79
GD1053614	74	GK1866790	79
GD1053615	74	GL0061674	89
GD1053621	74	GL0061684	89
GD1053638	74	GL0061685	89
GD1053639	74	GL0061696	89
GD1053641	74	GL0062614	89
GD1053683	74	GL0062638	89
GD1055601	74	GL0062645	89
GD1055667	74	GL0063612	89
GD1055678	74	GL0063614	89
GD1055689	74	GL0063638	89
GD1055690	74	GL0063645	89
GD1852612	79	GL0065014	89
GD1852614	79	GL0065601	89
GD1852638	79	GL0065667	89
GD1853612	79	GL0065678	89
GD1853613	79	GL0065689	89
GD1853614	79	GL0065690	89

Part Number Index

Part Number	Page Number	Part Number	Page Number
GL0072612	92	HA05041V0	25
GL0072614	92	HA0504200	26
GL0072638	92	HA05042E0	26
GL0073612	92	HA05042V0	26
GL0073614	92	HA0504300	25
GL0073638	92	HA05043E0	25
GL0075601	92	HA05043V0	25
GL0075613	92	HA0505100	25
GL0075667	92	HA05051E0	25
GL0075689	92	HA05051V0	25
HA0500100	25	HA0505200	26
HA05001E0	25	HA05052E0	26
HA05001V0	25	HA05052V0	26
HA0500200	26	HA0505300	25
HA05002E0	26	HA05053E0	25
HA05002V0	26	HA05053V0	25
HA0500300	25	HA05061E0	25
HA05003E0	25	HA05061V0	25
HA05003V0	25	HA05062E0	26
HA0501100	25	HA05062V0	26
HA05011E0	25	HA05063E0	25
HA05011V0	25	HA05063V0	25
HA0501200	26	HA05071E0	25
HA05012E0	26	HA05071V0	25
HA05012V0	26	HA05072E0	26
HA0501300	25	HA05072V0	26
HA05013E0	25	HA05073E0	25
HA05013V0	25	HA05073V0	25
HA0502100	25	HA05091E0	25
HA05021E0	25	HA05091V0	25
HA05021V0	25	HA05092E0	26
HA0502200	26	HA05092V0	26
HA05022E0	26	HA05093E0	25
HA05022V0	26	HA05093V0	25
HA0502300	25	HA0520100	25
HA05023E0	25	HA05201E0	25
HA05023V0	25	HA05201V0	25
HA0503100	25	HA0520200	26
HA05031E0	25	HA05202E0	26
HA05031V0	25	HA05202V0	26
HA0503200	26	HA0520300	25
HA05032E0	26	HA05203E0	25
HA05032V0	26	HA05203V0	25
HA0503300	25	HA0521100	25
HA05033E0	25	HA05211E0	25
HA05033V0	25	HA05211V0	25
HA0504100	25	HA0521200	26
HA05041E0	25	HA05212E0	26

Part Number Index

Part Number	Page Number	Part Number	Page Number
HA05212V0	26	HA05303V0	25
HA0521300	25	HA0531100	25
HA05213E0	25	HA05311E0	25
HA05213V0	25	HA05311V0	25
HA0522100	25	HA0531200	26
HA05221E0	25	HA05312E0	26
HA05221V0	25	HA05312V0	26
HA0522200	26	HA0531300	25
HA05222E0	26	HA05313E0	25
HA05222V0	26	HA05313V0	25
HA0522300	25	HA0532100	25
HA05223E0	25	HA05321E0	25
HA05223V0	25	HA05321V0	25
HA0523100	25	HA0532200	26
HA05231E0	25	HA05322E0	26
HA05231V0	25	HA05322V0	26
HA0523200	26	HA0532300	25
HA05232E0	26	HA05323E0	25
HA05232V0	26	HA05323V0	25
HA0523300	25	HA0533100	25
HA05233E0	25	HA05331E0	25
HA05233V0	25	HA05331V0	25
HA0524100	25	HA0533200	26
HA05241E0	25	HA05332E0	26
HA05241V0	25	HA05332V0	26
HA0524200	26	HA0533300	25
HA05242E0	26	HA05333E0	25
HA05242V0	26	HA05333V0	25
HA0524300	25	HA0534100	25
HA05243E0	25	HA05341E0	25
HA05243V0	25	HA05341V0	25
HA0525100	25	HA0534200	26
HA05251E0	25	HA05342E0	26
HA05251V0	25	HA05342V0	26
HA0525200	26	HA0534300	25
HA05252E0	26	HA05343E0	25
HA05252V0	26	HA05343V0	25
HA0525300	25	HA1501100	18
HA05253E0	25	HA1501200	18
HA05253V0	25	HA1502100	18
HA0530100	25	HA1502200	18
HA05301E0	25	HA1503100	18
HA05301V0	25	HA1503200	18
HA0530200	26	HA1503600	18
HA05302E0	26	HA1504100	18
HA05302V0	26	HA1504200	18
HA0530300	25	HA1505100	18
HA05303E0	25	HA1505200	18

Part Number Index

Part Number	Page Number	Part Number	Page Number
HA1521100	18	HL05013E0	28
HA1521200	18	HL05013V0	28
HA1522100	18	HL0502100	28
HA1522200	18	HL05021E0	28
HA1523100	18	HL05021V0	28
HA1523200	18	HL0502200	29
HA1524100	18	HL05022E0	29
HA1524200	18	HL05022V0	29
HA1525100	18	HL0502300	28
HA1525200	18	HL05023E0	28
HA5502100	144	HL05023V0	28
HA5502200	144	HL0503100	28
HA5503100	144	HL05031E0	28
HA5503200	144	HL05031V0	28
HD0510100	26, 29, 32, 122, 125, 128	HL0503200	29
HD0510200	26, 29, 32, 122, 125, 128	HL05032E0	29
HD0511100	26, 29, 32, 122, 125, 128	HL05032V0	29
HD0511200	26, 29, 32, 122, 125, 128	HL0503300	28
HD0512100	26, 29, 32, 122, 125, 128	HL05033E0	28
HD0512200	26, 29, 32, 122, 125, 128	HL05033V0	28
HD0513100	26, 29, 32, 122, 125, 128	HL0504100	28
HD0513200	26, 29, 32, 122, 125, 128	HL05041E0	28
HD0514100	26, 29, 32, 122, 125, 128	HL05041V0	28
HD0514200	26, 29, 32, 122, 125, 128	HL0504200	29
HD0515100	26, 29, 32, 122, 125, 128	HL05042E0	29
HD0515200	26, 29, 32, 122, 125, 128	HL05042V0	29
HD0516100	26, 29, 32, 122, 125, 128	HL0504300	28
HD0516200	26, 29, 32, 122, 125, 128	HL05043E0	28
HD0517100	26, 29, 32, 122, 125, 128	HL05043V0	28
HD0517200	26, 29, 32, 122, 125, 128	HL0505100	28
HD0519100	26, 29, 32, 122, 125, 128	HL05051E0	28
HD0519200	26, 29, 32, 122, 125, 128	HL05051V0	28
HL0500100	28	HL0505200	29
HL05001E0	28	HL05052E0	29
HL05001V0	28	HL05052V0	29
HL0500200	29	HL0505300	28
HL05002E0	29	HL05053E0	28
HL05002V0	29	HL05053V0	28
HL0500300	28	HL0506100	28
HL05003E0	28	HL05061E0	28
HL05003V0	28	HL05061V0	28
HL0501100	28	HL05062E0	29
HL05011E0	28	HL05062V0	29
HL05011V0	28	HL0506300	28
HL0501200	29	HL05063E0	28
HL05012E0	29	HL05063V0	28
HL05012V0	29	HL0507100	28
HL0501300	28	HL05071E0	28

Part Number Index

Part Number	Page Number	Part Number	Page Number
HL05071V0	28	HZ05031E0	31
HL05072E0	29	HZ05031V0	31
HL05072V0	29	HZ05032E0	32
HL0507300	28	HZ05032V0	32
HL05073E0	28	HZ05033E0	31
HL05073V0	28	HZ05033V0	31
HL0509100	28	HZ05041E0	31
HL05091E0	28	HZ05041V0	31
HL05091V0	28	HZ05042E0	32
HL05092E0	29	HZ05042V0	32
HL05092V0	29	HZ05043E0	31
HL0509300	28	HZ05043V0	31
HL05093E0	28	HZ05051E0	31
HL05093V0	28	HZ05051V0	31
HL2T15	117	HZ05052E0	32
HL2T16	118	HZ05052V0	32
HL3T20	117	HZ05053E0	31
HL3T21	118	HZ05053V0	31
HP1511100	18	HZ05061E0	31
HP1511200	18	HZ05061V0	31
HP1512100	18	HZ05062E0	32
HP1512200	18	HZ05062V0	32
HP1513100	18, 23	HZ05063E0	31
HP1513200	18, 23	HZ05063V0	31
HP1514100	18	HZ05071E0	31
HP1514200	18	HZ05071V0	31
HP1515100	18	HZ05072E0	32
HP1515200	18	HZ05072V0	32
HP3PB37F	68	HZ05073E0	31
HP3SB37M	68	HZ05073V0	31
HZ05001E0	31	HZ05091E0	31
HZ05001V0	31	HZ05091V0	31
HZ05002E0	32	HZ05092E0	32
HZ05002V0	32	HZ05092V0	32
HZ05003E0	31	HZ05093E0	31
HZ05003V0	31	HZ05093V0	31
HZ05011E0	31	HZ05201E0	31
HZ05011V0	31	HZ05201V0	31
HZ05012E0	32	HZ05202E0	32
HZ05012V0	32	HZ05202V0	32
HZ05013E0	31	HZ05211E0	31
HZ05013V0	31	HZ05211V0	31
HZ05021E0	31	HZ05212E0	32
HZ05021V0	31	HZ05212V0	32
HZ05022E0	32	HZ05221E0	31
HZ05022V0	32	HZ05221V0	31
HZ05023E0	31	HZ05222E0	32
HZ05023V0	31	HZ05222V0	32

Part Number Index

Part Number	Page Number	Part Number	Page Number
HZ05231E0	31	ID1097083	77
HZ05231V0	31	ID1895012	81
HZ05232E0	32	ID1895038	81
HZ05232V0	32	ID1895601	81
HZ05241E0	31	ID1895613	81
HZ05241V0	31	ID1895689	81
HZ05242E0	32	ID1895690	81
HZ05242V0	32	ID1896012	81
HZ05251E0	31	ID1896013	81
HZ05251V0	31	ID1896014	81
HZ05252E0	32	ID1896015	81
HZ05252V0	32	ID1896038	81
IA0090612	77, 94	ID1896039	81
IA0090614	77, 94	ID1897012	81
IA0090638	77, 94	ID1897014	81
IA0090712	77, 94	ID1897038	81
IA0090714	77, 94	IK1890612	81
IA0090738	77, 94	IK1890613	81
IA0090901	77, 94	IK1890614	81
IA0090912	77, 94	IK1890615	81
IA0090978	77, 94	IK1890638	81
IA0090989	77, 94	IK1890639	81
IA0090990	77, 94	IK1890641	81
IA0100612	96	IK1890683	81
IA0100638	96	IK1890712	81
IA0100712	96	IK1890714	81
IA0100738	96	IK1890738	81
IA0100901	96	IK1890741	81
IA0100912	96	IK1890783	81
IA0100990	96	IK1890901	81
ID1095601	77	IK1890913	81
ID1095678	77	IK1890989	81
ID1095689	77	IK1890990	81
ID1095690	77	IL0095601	94
ID1096012	77	IL0095689	94
ID1096013	77	IL0095690	94
ID1096014	77	IL0096012	94
ID1096015	77	IL0096014	94
ID1096021	77	IL0096038	94
ID1096038	77	IL0097012	94
ID1096039	77	IL0097014	94
ID1096041	77	IL0097038	94
ID1096083	77	IL0105601	96
ID1097012	77	IL0105689	96
ID1097014	77	IL0105690	96
ID1097021	77	IL0106012	96
ID1097038	77	IL0106014	96
ID1097041	77	IL0106038	96

Part Number Index

Part Number	Page Number	Part Number	Page Number
IL0107012	96	LA0700200	121
IL0107014	96	LA0701100	121
IL0107038	96	LA07011E0	121
J62P082	120	LA07011V0	121
J62P083	120	LA0701200	121
J62P122	120	LA0702100	121
J62P123	120	LA07021E0	121
JL7083114	120	LA07021V0	121
JL7083118	120	LA0702200	121
JL7083214	120	LA0703100	121
JL7083218	120	LA07031E0	121
JL7083314	120	LA07031V0	121
JL7083318	120	LA0703200	121
JL7083414	120	LA0704100	121
JL7083614	120	LA07041E0	121
JL7083618	120	LA07041V0	121
JL7083638	120	LA0704200	121
JL7086214	120	LA0705100	121
JL7086701	119	LA07051E0	121
JL7086712	119	LA07051V0	121
JL7086789	119	LA0705200	121
JL7086812	120	LA07061E0	121
JL7086838	120	LA07061V0	121
JL7088201	119	LA0706200	121
JL7088212	119	LA07071E0	121
JL7088289	119	LA07071V0	121
JL7088301	120	LA0707200	121
JL7088312	120	LA07091E0	121
JL7088389	120	LA07091V0	121
JL7123612	120	LA0709200	121
JL7123638	120	LL0700100	124
JL7126212	120	LL07001E0	124
JL7126713	119	LL07001V0	124
JL7126716	119	LL0700200	124
JX5062614	118	LL0701100	124
JX5067215	118	LL07011E0	124
JX5068214	118	LL07011V0	124
JX5092638	118	LL0701200	124
JX5097239	118	LL0702100	124
KA0802412	139	LL07021E0	124
KA0812700	139	LL07021V0	124
KA0832412	139	LL0702200	124
KA0832413	139	LL0703100	124
KA0832718	139	LL07031E0	124
KP0812400	139	LL07031V0	124
LA0700100	121	LL0703200	124
LA07001E0	121	LL0704100	124
LA07001V0	121	LL07041E0	124

Part Number Index

Part Number	Page Number	Part Number	Page Number
LL07041V0	124	LL1S11BS	118
LL0704200	124	LL1S12	119
LL0705100	124	LL1S17	119
LL07051E0	124	LL1T10	117
LL07051V0	124	LL1T11	118
LL0705200	124	LL1T11BS	118
LL07061E0	124	LL1T12	119
LL07061V0	124	LL1T17	119
LL0706200	124	LL20H51	15
LL07071E0	124	LL20H51BS	15
LL07071V0	124	LL20H56	15
LL0707200	124	LL20H56BS	15
LL07091E0	124	LL20H61	15
LL07091V0	124	LL20H61BS	15
LL0709200	124	LL20K51	16
LL10	85	LL20K51BS	16
LL1000	85	LL20K56	16
LL10H41	15	LL20K56BS	16
LL10H41BS	15	LL20K61	16
LL10K41	16	LL20K61BS	16
LL10K41BS	16	LL2H16	15
LL10S41	118	LL2H16BS	15
LL10T40	117	LL2H6	15
LL10T41	118	LL2K16	16
LL10T41BS	118	LL2K16BS	16
LL11	85	LL2K6	16
LL1100	85	LL2S15	117
LL12H41	15	LL2S16	118
LL12H41BS	15	LL2S16BS	118
LL12H46	15	LL2S17	119
LL12H46BS	15	LL2T15	117
LL12K41	16	LL2T15BS	117
LL12K41BS	16	LL2T16	118
LL12K46	16	LL2T16BS	118
LL12K46BS	16	LL2T17	119
LL12S46	118	LL3H21	15
LL12S46BS	118	LL3H21BS	15
LL12T46	118	LL3H8	15
LL12T46BS	118	LL3K21	16
LL16S51	118	LL3K21BS	16
LL16S51BS	118	LL3K8	16
LL16T50	117	LL3S20	117
LL1H11	15	LL3S20BS	117
LL1H4	15	LL3S21	118
LL1K11	16	LL3S21BS	118
LL1K4	16	LL3S22	119
LL1S10	117	LL3T20	117
LL1S11	118	LL3T20BS	117

Part Number Index

Part Number	Page Number	Part Number	Page Number
LL3T21	118	LZ0700200	127
LL3T21BS	118	LZ07011E0	127
LL3T22	119	LZ07011V0	127
LL4HP10	15	LZ0701200	127
LL4HP26	15	LZ07021E0	127
LL4HP26BS	15	LZ07021V0	127
LL4KP10	16	LZ0702200	127
LL4KP26	16	LZ07031E0	127
LL4KP26BS	16	LZ07031V0	127
LL4S25	117	LZ0703200	127
LL4S25BS	117	LZ07041E0	127
LL4S26	118	LZ07041V0	127
LL4S26BS	118	LZ0704200	127
LL4S27	119	LZ07051E0	127
LL4T25	117	LZ07051V0	127
LL4T25BS	117	LZ0705200	127
LL4T26	118	LZ07061E0	127
LL4T26BS	118	LZ07061V0	127
LL4T27	119	LZ0706200	127
LL6HP12	15	LZ07071E0	127
LL6HP31	15	LZ07071V0	127
LL6HP31BS	15	LZ0707200	127
LL6KP12	16	LZ07091E0	127
LL6KP31	16	LZ07091V0	127
LL6KP31BS	16	LZ0709200	127
LL6S30	117	MA0024145	102
LL6S31	118	MA0024188	102
LL6S31BS	118	MA0024214	103
LL6S32	119	MA0024228	103
LL6T30	117	MA0024242	103
LL6T30BS	117	MA0024248	103
LL6T31	118	MA0024284	103
LL6T31BS	118	MA0024310	102
LL6T32	119	MA0024312	102
LL8HP16	15	MA0024314	102
LL8HP36	15	MA0024318	102
LL8HP36BS	15	MA0024334	102
LL8KP16	16	MA0024338	102
LL8KP36	16	MA0024424	102
LL8KP36BS	16	MA0024441	102
LL8S36	118	MA0024448	102
LL8S36BS	118	MA0024482	102
LL8S37	119	MA0024484	102
LL8T35	117	MA0024512	102
LL8T36	118	MA0024524	102
LL8T36BS	118	MA0024548	102
LZ07001E0	127	MA0024588	102
LZ07001V0	127	MA0024610	104

Part Number Index

Part Number	Page Number	Part Number	Page Number
MA0024612	104	ML0028138	105
MA0024614	104	ML0028210	105
MA0024618	104	ML0028212	105
MA0024634	104	ML0028214	105
MA0024638	104	ML0028218	105
MA0025514	103	ML0028234	105
MA0025528	103	ML0028238	105
MA0025542	103	ML0028410	106
MA0025548	103	ML0028412	106
MA0025584	103	ML0028414	106
MA0025612	103	ML0028418	106
MA0025624	103	ML0028434	106
MA0025648	103	ML0028438	106
MA0025688	103	ML0028612	105
MA0026610	104	ML0028614	105
MA0026612	104	ML0028618	105
MA0026614	104	ML0028638	105
MA0026618	104	ML10FFP37	39
MA0026634	104	ML10FFP37143	39
MA0026638	104	ML10FFP37192	39
MA0026714	104	ML10FFP37BS	39
MA0026728	104	ML10FFP37BS143	39
MA0026742	104	ML10FFP37BS192	39
MA0026748	104	ML10FFP50BS	39
MA0026784	104	ML10FFP50BS143	39
MA0026812	103	ML10FFP50BS192	39
MA0026824	103	ML10FFS37	39
MA0026848	103	ML10FFS37143	39
MA0026888	103	ML10FFS37192	39
MA0026910	104	ML10FFS37BS	39
MA0026912	104	ML10FFS37BS143	39
MA0026914	104	ML10FFS37BS192	39
MA0026918	104	ML10FFS50BS	39
MA0026934	104	ML10FFS50BS143	39
MA0026938	106	ML10FFS50BS192	39
MA0027828	103	ML12FFP50	39
MA0027842	103	ML12FFP50143	39
MA0027848	103	ML12FFP50192	39
MA0027884	103	ML12FFP50BS	39
ML0028010	105	ML12FFP50BS143	39
ML0028012	105	ML12FFP50BS192	39
ML0028014	105	ML12FFP75BS	39
ML0028018	105	ML12FFP75BS143	39
ML0028034	105	ML12FFP75BS192	39
ML0028038	105	ML12FFS50	39
ML0028112	105	ML12FFS50143	39
ML0028114	105	ML12FFS50192	39
ML0028118	105	ML12FFS50BS	39

Part Number Index

Part Number	Page Number	Part Number	Page Number
ML12FFS50BS143	39	ML25FFP125192	39
ML12FFS50BS192	39	ML40FFP150	39
ML12FFS75BS	39	ML40FFP150143	39
ML12FFS75BS143	39	ML40FFP150BS	39
ML12FFS75BS192	39	ML50FFP200143	39
ML16FFP75	39	ML25FFS100BS	39
ML16FFP75143	39	ML25FFS100BS143	39
ML16FFP75192	39	ML25FFS100BS192	39
ML16FFP75BS	39	ML25FFS125	39
ML16FFP75BS143	39	ML25FFS125143	39
ML16FFP75BS192	39	ML25FFS125192	39
ML16FFS75	39	ML40FFS150	39
ML16FFS75143	39	ML40FFS150143	39
ML16FFS75192	39	ML40FFS150BS	39
ML16FFS75BS	39	ML50FFS200143	39
ML16FFS75BS143	39	ML2DBP25F	45
ML16FFS75BS192	39	ML2DBP25F242	45
ML19FFP100	39	ML2DBP25F292	45
ML19FFP100143	39	ML2DBP25F503	45
ML19FFP100192	39	ML2DBP25FBS	45
ML19FFP100BS	39	ML2DBP25FBS242	45
ML19FFP100BS143	39	ML2DBP25FBS292	45
ML19FFP100BS192	39	ML2DBP25FBS503	45
ML19FFP75	39	ML2DBS25F	45
ML19FFP75143	39	ML2DBS25F242	45
ML19FFP75192	39	ML2DBS25F292	45
ML19FFP75BS	39	ML2DBS25F503	45
ML19FFP75BS143	39	ML2DBS25FBS	45
ML19FFP75BS192	39	ML2DBS25FBS242	45
ML19FFS100	39	ML2DBS25FBS292	45
ML19FFS100143	39	ML2DBS25FBS503	45
ML19FFS100192	39	ML2DBS93	45
ML19FFS100BS	39	ML2H16	15
ML19FFS100BS143	39	ML2H16BS	15
ML19FFS100BS192	39	ML2K16	16
ML19FFS75	39	ML2K16BS	16
ML19FFS75143	39	ML2K16C	16
ML19FFS75192	39	ML3H21	15
ML19FFS75BS	39	ML3H21BS	15
ML19FFS75BS143	39	ML3K21BS	16
ML19FFS75BS192	39	ML3K21C	16
ML1H11	15	ML4DBP50F	45
ML1K11	16	ML4DBP50F242	45
ML25FFP100BS	39	ML4DBP50F292	45
ML25FFP100BS143	39	ML4DBP50F503	45
ML25FFP100BS192	39	ML4DBP50FBS	45
ML25FFP125	39	ML4DBP50FBS242	45
ML25FFP125143	39	ML4DBP50FBS292	45

Part Number Index

Part Number	Page Number	Part Number	Page Number
ML4DBP50FBS503	45	ML6KP31BS	16
ML4DBS50F	45	ML8DBP100F	45
ML4DBS50F242	45	ML8DBP100F242	45
ML4DBS50F292	45	ML8DBP100F292	45
ML4DBS50F503	45	ML8DBP100F503	45
ML4DBS50FBS	45	ML8DBP100FBS	45
ML4DBS50FBS242	45	ML8DBP100FBS242	45
ML4DBS50FBS292	45	ML8DBP100FBS292	45
ML4DBS50FBS503	45	ML8DBP100FBS503	45
ML4DBS93	45	ML8DBS100F	45
ML4HP26	15	ML8DBS100F242	45
ML4HP26BS	15	ML8DBS100F292	45
ML4KP26	16	ML8DBS100F503	45
ML4KP26BS	16	ML8DBS100FBS	45
ML50FFP200143	39	ML8DBS100FBS242	45
ML50FFS200143	39	ML8DBS100FBS292	45
ML6DBP75F	45	ML8DBS100FBS503	45
ML6DBP75F242	45	ML8DBS93	45
ML6DBP75F292	45	ML8HP36	15
ML6DBP75F503	45	ML8HP36BS	15
ML6DBP75FBS	45	ML8KP36	16
ML6DBP75FBS242	45	ML8KP36BS	16
ML6DBP75FBS292	45	PDC10FF	37
ML6DBP75FBS503	45	PDC12FF	37
ML6DBS75F	45	PDC12HK	10, 13, 16
ML6DBS75F242	45	PDC16FF	37
ML6DBS75F292	45	PDC19FF	37
ML6DBS75F503	45	PDC1HK	10, 13, 16
ML6DBS75FBS	45	PDC20HK	10, 13, 16
ML6DBS75FBS242	45	PDC25FF	37
ML6DBS75FBS292	45	PDC2HK	10, 13, 16
ML6DBS75FBS503	45	PDC3HK	10, 13, 16
ML6DBS93	45	PDC4HK	10, 13, 16
ML6FFP25	39	PDC6FF	37
ML6FFP25143	39	PDC6HK	10, 13, 16
ML6FFP25192	39	PDC8HK	10, 13, 16
ML6FFP25BS	39	PPDC1HK	10, 13, 16
ML6FFP25BS143	39	PPDC2HK	10, 13, 16
ML6FFP25BS192	39	PPDC2UH	72
ML6FFS25	39	PPDC3HK	10, 13, 16
ML6FFS25143	39	PPDC4HK	124
ML6FFS25192	39	PPDC4HK(RD)	10, 13, 16
ML6FFS25BS	39	PPDC6HK	124
ML6FFS25BS143	39	PPDC6HK(RD)	10, 13, 16
ML6FFS25BS192	39	PPDC8HK	124
ML6HP31	15	PPDC8HK(RD)	10, 13, 16
ML6HP31BS	15	PSDC1HK	10, 13, 16
ML6KP31	16	PSDC1HK	119

Part Number Index

Part Number	Page Number	Part Number	Page Number
PSDC2HK	10, 13, 16	RA04050VB	130
PSDC2HK	119	RA04060E0	130
PSDC2UH	72	RA04060EB	130
PSDC3HK	10, 13, 16	RA04060V0	130
PSDC4HK	119	RA04060VB	130
PSDC4HK(RD)	10, 13, 16	RA04070E0	130
PSDC6HK(RD)	10, 13, 16	RA04070EB	130
PSDC8HK(RD)	10, 13, 16	RA04070V0	130
QA0912100	140	RA04070VB	130
QA0932118	140	RA04090E0	130
QA0932212	140	RA04090EB	130
QA0932213	140	RA04090V0	130
QP0912200	140	RA04090VB	130
RA0400000	130	RL0400000	132
RA040000B	130	RL040000B	132
RA04000E0	130	RL04000E0	132
RA04000EB	130	RL04000EB	132
RA04000V0	130	RL04000V0	132
RA04000VB	130	RL04000VB	132
RA0401000	130	RL0401000	132
RA040100B	130	RL040100B	132
RA04010E0	130	RL04010E0	132
RA04010EB	130	RL04010EB	132
RA04010V0	130	RL04010V0	132
RA04010VB	130	RL04010VB	132
RA0402000	130	RL0402000	132
RA040200B	130	RL040200B	132
RA04020E0	130	RL04020E0	132
RA04020EB	130	RL04020EB	132
RA04020V0	130	RL04020V0	132
RA04020VB	130	RL04020VB	132
RA0403000	130	RL0403000	132
RA040300B	130	RL040300B	132
RA04030E0	130	RL04030E0	132
RA04030EB	130	RL04030EB	132
RA04030V0	130	RL04030V0	132
RA04030VB	130	RL04030VB	132
RA0404000	130	RL0404000	132
RA040400B	130	RL040400B	132
RA04040E0	130	RL04040E0	132
RA04040EB	130	RL04040EB	132
RA04040V0	130	RL04040V0	132
RA04040VB	130	RL04040VB	132
RA0405000	130	RL0405000	132
RA040500B	130	RL040500B	132
RA04050E0	130	RL04050E0	132
RA04050EB	130	RL04050EB	132
RA04050V0	130	RL04050V0	132

Part Number Index

Part Number	Page Number	Part Number	Page Number
RL04050VB	132	RZ04090VB	134
RL04060E0	132	SA0017014	101
RL04060EB	132	SA0017514	101
RL04060V0	132	SDC10FF	37
RL04060VB	132	SDC12FF	37
RL04070E0	132	SDC12HK	10, 13, 16
RL04070EB	132	SDC16FF	37
RL04070V0	132	SDC19FF	37
RL04070VB	132	SDC1HK	10, 13, 16
RL04090E0	132	SDC20HK	10, 13, 16
RL04090EB	132	SDC25FF	37
RL04090V0	132	SDC2HK	10, 13, 16
RL04090VB	132	SDC3HK	10, 13, 16
RZ04000E0	134	SDC4HK	10, 13, 16
RZ04000EB	134	SDC6FF	37
RZ04000V0	134	SDC6HK	10, 13, 16
RZ04000VB	134	SDC8HK	10, 13, 16
RZ04010E0	134	SP0020014	101
RZ04010EB	134	SPUBD0584E	108
RZ04010V0	134	SPUBD65104E	108
RZ04010VB	134	TA0111512	98
RZ04020E0	134	TA0111538	98
RZ04020EB	134	TA0111612	98
RZ04020V0	134	TA0111638	98
RZ04020VB	134	TA0111813	98
RZ04030E0	134	TA0111816	98
RZ04030EB	134	TA0111819	98
RZ04030V0	134	TA0131512	100
RZ04030VB	134	TA0131538	100
RZ04040E0	134	TA0131612	100
RZ04040EB	134	TA0131638	100
RZ04040V0	134	TA0131813	100
RZ04040VB	134	TA0131816	100
RZ04050E0	134	TA0131819	100
RZ04050EB	134	TD1832012	83
RZ04050V0	134	TD1832034	83
RZ04050VB	134	TD1832112	83
RZ04060E0	134	TD1832134	83
RZ04060EB	134	TD1832138	83
RZ04060V0	134	TD1835012	83
RZ04060VB	134	TD1835034	83
RZ04070E0	134	TD1835601	83
RZ04070EB	134	TD1835613	83
RZ04070V0	134	TD1835616	83
RZ04070VB	134	TK1831512	83
RZ04090E0	134	TK1831534	83
RZ04090EB	134	TK1831539	83
RZ04090V0	134	TK1831612	83

Part Number Index

Part Number	Page Number	Part Number	Page Number
TK1831634	83	WA0605400	63
TK1831638	83	WA06054E0	63
TK1831801	83	WA06054V0	63
TK1831813	83	WA0605700	63
TK1831816	83	WA06057E0	63
TK1831889	83	WA06057V0	63
TL0112012	98	WA0606400	63
TL0112034	98	WA06064E0	63
TL0112038	98	WA06064V0	63
TL0112112	98	WA0606700	63
TL0112134	98	WA06067E0	63
TL0112138	98	WA06067V0	63
TL0115601	98	WA0607400	63
TL0115613	98	WA06074E0	63
TL0115616	98	WA06074V0	63
TL0132012	100	WA0607700	63
TL0132034	100	WA06077E0	63
TL0132038	100	WA06077V0	63
TL0132112	100	WA0609400	63
TL0132134	100	WA06094E0	63
TL0132138	100	WA06094V0	63
TL0135601	100	WA0609700	63
TL0135613	100	WA06097E0	63
TL0135616	100	WA06097V0	63
WA0601400	63	WA0621400	63
WA06014E0	63	WA06214E0	63
WA06014V0	63	WA06214V0	63
WA0601700	63	WA0621700	63
WA06017E0	63	WA06217E0	63
WA06017V0	63	WA06217V0	63
WA0602400	63	WA0622400	63
WA06024E0	63	WA06224E0	63
WA06024V0	63	WA06224V0	63
WA0602700	63	WA0622700	63
WA06027E0	63	WA06227E0	63
WA06027V0	63	WA06227V0	63
WA0603400	63	WA0623400	63
WA06034E0	63	WA06234E0	63
WA06034V0	63	WA06234V0	63
WA0603700	63	WA0623700	63
WA06037E0	63	WA06237E0	63
WA06037V0	63	WA06237V0	63
WA0604400	63	WA0624400	63
WA06044E0	63	WA06244E0	63
WA06044V0	63	WA06244V0	63
WA0604700	63	WA0624700	63
WA06047E0	63	WA06247E0	63
WA06047V0	63	WA06247V0	63

Part Number Index

Part Number	Page Number	Part Number	Page Number
WA0625400	63	WA3604700	58
WA06254E0	63	WA3604750BS	58
WA06254V0	63	WA3605400	59
WA0625700	63	WA3605475BS	59
WA06257E0	63	WA3605700	58
WA06257V0	63	WA3605775BS	58
WA0626400	63	WA3606400	59
WA06264E0	63	WA36064150BS	59
WA06264V0	63	WA3606700	58
WA0626700	63	WA36067150BS	58
WA06267E0	63	WA3621425	59
WA06267V0	63	WA3621725	58
WA0627400	63	WA3622425	59
WA06274E0	63	WA3622437	59
WA06274V0	63	WA3622725	58
WA0627700	63	WA3622737	58
WA06277E0	63	WA3623437	59
WA06277V0	63	WA3623450	59
WA0629400	63	WA3623737	58
WA06294E0	63	WA3623750	58
WA06294V0	63	WA3624450	59
WA0629700	63	WA3624475	59
WA06297E0	63	WA3624750	58
WA06297V0	63	WA3624775	58
WA0633400	63	WA36254100	59
WA06334E0	63	WA3625475	59
WA06334V0	63	WA36257100	58
WA0633700	63	WA3625775	58
WA06337E0	63	WA36264125	59
WA06337V0	63	WA36264150	59
WA0635400	63	WA36267125	58
WA06354E0	63	WA36267150	58
WA06354V0	63	WA3633408L	59
WA0635700	63	WA3633410L	59
WA06357E0	63	WA3633412L	59
WA06357V0	63	WA3633415L	59
WA3601400	59	WA3633415LBH	59
WA3601700	58	WA3633708L	58
WA3602400	59	WA3633710L	58
WA3602425BS	59	WA3633712L	58
WA3602700	58	WA3633715L	58
WA3602725BS	58	WA3633715LBH	58
WA3603400	59	WA4604400	56
WA3603437BS	59	WA4604700	56
WA3603700	58	WA4605400	56
WA3603737BS	58	WA4605700	56
WA3604400	59	WA4614400	56
WA3604450BS	59	WA4614700	56

Part Number Index

Part Number	Page Number	Part Number	Page Number
WA4615400	56	WP3613400	60
WA4615700	56	WP3613700	60
WA5611400	69	WP3614400	60
WA5611700	69	WP3614700	60
WA5612400	68, 69	WP3615400	60
WA5612700	68, 69	WP3615700	60
WA5651400	69	WP3616400	60
WA5651700	69	WP3616700	60
WA5652400	69	WV06014E0	66
WA5652700	69	WV06014V0	66
WD0611400	64, 67	WV06017E0	66
WD0611700	64, 67	WV06017V0	66
WD0612400	64, 67	WV06024E0	66
WD0612700	64, 67	WV06024V0	66
WD0613400	64, 67	WV06027E0	66
WD0613700	64, 67	WV06027V0	66
WD0614400	64, 67	WV06034E0	66
WD0614700	64, 67	WV06034V0	66
WD0615400	64, 67	WV06037E0	66
WD0615700	64, 67	WV06037V0	66
WD0616400	64, 67	WV06044E0	66
WD0616700	64, 67	WV06044V0	66
WD0617400	64, 67	WV06047E0	66
WD0617700	64, 67	WV06047V0	66
WD0619400	64, 67	WV06054E0	66
WD0619700	64, 67	WV06054V0	66
WD3611400	60	WV06057E0	66
WD3611700	60	WV06057V0	66
WD3612400	60	WV06064E0	66
WD3612700	60	WV06064V0	66
WD3613400	60	WV06067E0	66
WD3613700	60	WV06067V0	66
WD3614400	60	WV06074E0	66
WD3614700	60	WV06074V0	66
WD3615400	60	WV06077E0	66
WD3615700	60	WV06077V0	66
WD3616400	60	WV06094E0	66
WD3616700	60	WV06094V0	66
WG3601700	60	WV06097E0	66
WG3602700	60	WV06097V0	66
WG3603700	60	WV06214E0	66
WG3604700	60	WV06214V0	66
WG3605700	60	WV06217E0	66
WG3606700	60	WV06217V0	66
WP3611400	60	WV06224E0	66
WP3611700	60	WV06224V0	66
WP3612400	60	WV06227E0	66
WP3612700	60	WV06227V0	66

Part Number Index

Part Number	Page Number
WV06234E0	66
WV06234V0	66
WV06237E0	66
WV06237V0	66
WV06244E0	66
WV06244V0	66
WV06247E0	66
WV06247V0	66
WV06254E0	66
WV06254V0	66
WV06257E0	66
WV06257V0	66
WV06264E0	66
WV06264V0	66
WV06267E0	66
WV06267V0	66
WV06274E0	66
WV06274V0	66
WV06277E0	66
WV06277V0	66
WV06294E0	66
WV06294V0	66
WV06297E0	66
WV06297V0	66

Eaton
Hydraulics Group USA
14615 Lone Oak Road
Eden Prairie, MN 55344
USA
Tel: 952-937-9800
Fax: 952-294-7722
www.eaton.com/hydraulics

Eaton
Hydraulics Group Europe
Route de la Longeraie 7
1110 Morges
Switzerland
Tel: +41 (0) 21 811 4600
Fax: +41 (0) 21 811 4601

Eaton
Hydraulics Group Asia Pacific
Eaton Building
No.7 Lane 280 Linhong Road
Changning District,
Shanghai 200335
China
Tel: (+86 21) 5200 0099
Fax: (+86 21) 2230 7240