

CD4001BC/CD4011BC

Quad 2-Input NOR Buffered B Series Gate • Quad 2-Input NAND Buffered B Series Gate

General Description

The CD4001BC and CD4011BC quad gates are monolithic complementary MOS (CMOS) integrated circuits constructed with N- and P-channel enhancement mode transistors. They have equal source and sink current capabilities and conform to standard B series output drive. The devices also have buffered outputs which improve transfer characteristics by providing very high gain.

All inputs are protected against static discharge with diodes to V_{DD} and V_{SS} .

Features

- Low power TTL:
 - Fan out of 2 driving 74L compatibility: or 1 driving 74LS
- 5V–10V–15V parametric ratings
- Symmetrical output characteristics
- Maximum input leakage 1 μ A at 15V over full temperature range

Ordering Code:

Order Number	Package Number	Package Description
CD4001BCM	M14A	14-Lead Small Outline Integrated Circuit (SOIC), JEDEC MS-012, 0.150" Narrow
CD4001BCSJ	M14D	14-Lead Small Outline Package (SOP), EIAJ TYPE II, 5.3mm Wide
CD4001BCN	N14A	14-Lead Plastic Dual-In-Line Package (PDIP), JEDEC MS-001, 0.300" Wide
CD4011BCM	M14A	14-Lead Small Outline Integrated Circuit (SOIC), JEDEC MS-012, 0.150" Narrow
CD4011BCN	N14A	14-Lead Plastic Dual-In-Line Package (PDIP), JEDEC MS-001, 0.300" Wide

Devices also available in Tape and Reel. Specify by appending the suffix letter "X" to the ordering code.

Connection Diagrams

Pin Assignments for DIP, SOIC and SOP
CD4001BC

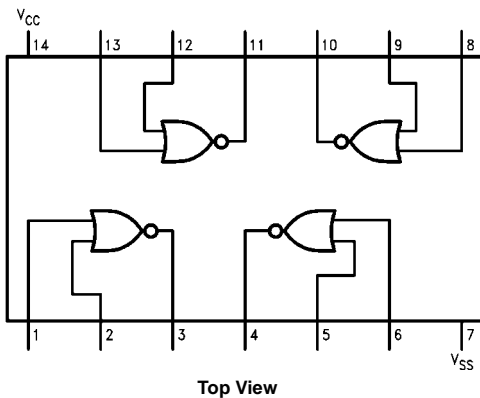

Pin Assignments for DIP and SOIC
CD4011BC

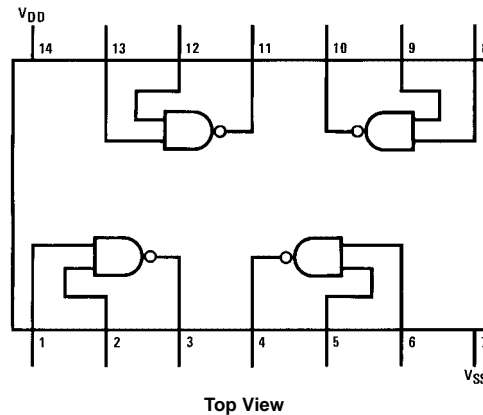

Schematic Diagrams

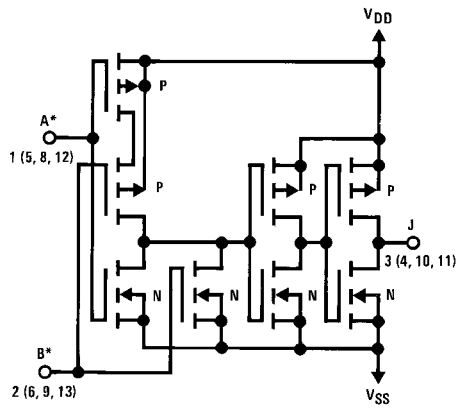

$1/4$ of device shown
 $J = \overline{A + B}$
 Logical "1" = HIGH
 Logical "0" = LOW
 All inputs protected by standard
 CMOS protection circuit.

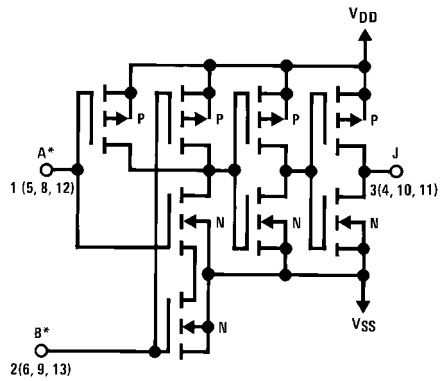
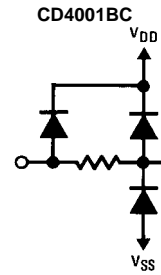

$1/4$ of device shown
 $J = \overline{A \cdot B}$
 Logical "1" = HIGH
 Logical "0" = LOW
 All inputs protected by standard
 CMOS protection circuit.

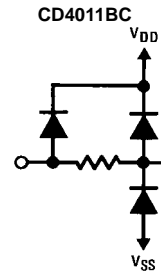

Absolute Maximum Ratings ^(Note 1)		Recommended Operating Conditions	
(Note 2)			
Voltage at any Pin	-0.5V to V _{DD} +0.5V	Operating Range (V _{DD})	3 V _{DC} to 15 V _{DC}
Power Dissipation (P _D)		Operating Temperature Range	
Dual-In-Line	700 mW	CD4001BC, CD4011BC	-55°C to +125°C
Small Outline	500 mW		
V _{DD} Range	-0.5 V _{DC} to +18 V _{DC}	Note 1: "Absolute Maximum Ratings" are those values beyond which the safety of the device cannot be guaranteed. Except for "Operating Temperature Range" they are not meant to imply that the devices should be operated at these limits. The Electrical Characteristics tables provide conditions for actual device operation.	
Storage Temperature (T _S)	-65°C to +150°C	Note 2: All voltages measured with respect to V _{SS} unless otherwise specified.	
Lead Temperature (T _L)			
(Soldering, 10 seconds)	260°C		

DC Electrical Characteristics (Note 2)

Symbol	Parameter	Conditions	-55°C		+25°C			+125°C		Units
			Min	Max	Min	Typ	Max	Min	Max	
I _{DD}	Quiescent Device Current	V _{DD} = 5V, V _{IN} = V _{DD} or V _{SS} V _{DD} = 10V, V _{IN} = V _{DD} or V _{SS} V _{DD} = 15V, V _{IN} = V _{DD} or V _{SS}		0.25 0.5 1.0		0.004 0.005 0.006	0.25 0.50 1.0		7.5 15 30	μA
V _{OL}	LOW Level Output Voltage	V _{DD} = 5V V _{DD} = 10V, I _O < 1 μA V _{DD} = 15V		0.05 0.05 0.05		0 0 0	0.05 0.05 0.05		0.05 0.05 0.05	V
V _{OH}	HIGH Level Output Voltage	V _{DD} = 5V V _{DD} = 10V, I _O < 1 μA V _{DD} = 15V	4.95 9.95 14.95		4.95 9.95 14.95	5 10 15		4.95 9.95 14.95		V
V _{IL}	LOW Level Input Voltage	V _{DD} = 5V, V _O = 4.5V V _{DD} = 10V, V _O = 9.0V V _{DD} = 15V, V _O = 13.5V		1.5 3.0 4.0		2 4 6	1.5 3.0 4.0		1.5 3.0 4.0	V
V _{IH}	HIGH Level Input Voltage	V _{DD} = 5V, V _O = 0.5V V _{DD} = 10V, V _O = 1.0V V _{DD} = 15V, V _O = 1.5V	3.5 7.0 11.0		3.5 7.0 11.0	3 6 9		3.5 7.0 11.0		V
I _{OL}	LOW Level Output Current (Note 3)	V _{DD} = 5V, V _O = 0.4V V _{DD} = 10V, V _O = 0.5V V _{DD} = 15V, V _O = 1.5V	0.64 1.6 4.2		0.51 1.3 3.4	0.88 2.25 8.8		0.36 0.9 2.4		mA
I _{OH}	HIGH Level Output Current (Note 3)	V _{DD} = 5V, V _O = 4.6V V _{DD} = 10V, V _O = 9.5V V _{DD} = 15V, V _O = 13.5V	-0.64 -1.6 -4.2		-0.51 -1.3 -3.4	-0.88 -2.25 -8.8		-0.36 -0.9 -2.4		mA
I _{IN}	Input Current	V _{DD} = 15V, V _{IN} = 0V V _{DD} = 15V, V _{IN} = 15V		-0.10 0.1		-10 ⁻⁶ 10 ⁻⁵	-0.10 0.10		-1.0 1.0	μA

Note 3: I_{OL} and I_{OH} are tested one output at a time.

AC Electrical Characteristics (Note 4)

CD4001BC: T_A = 25°C, Input t_r: t_f = 20 ns. C_L = 50 pF, R_L = 200k. Typical temperature coefficient is 0.3%/°C.

Symbol	Parameter	Conditions	Typ	Max	Units
t _{PHL}	Propagation Delay Time, HIGH-to-LOW Level	V _{DD} = 5V V _{DD} = 10V V _{DD} = 15V	120 50 35	250 100 70	ns
t _{PLH}	Propagation Delay Time, LOW-to-HIGH Level	V _{DD} = 5V V _{DD} = 10V V _{DD} = 15V	110 50 35	250 100 70	ns
t _{THL}, t_{TLH}}	Transition Time	V _{DD} = 5V V _{DD} = 10V V _{DD} = 15V	90 50 40	200 100 80	ns
C _{IN}	Average Input Capacitance	Any Input	5	7.5	pF
C _{PD}	Power Dissipation Capacity	Any Gate	14		pF

Note 4: AC Parameters are guaranteed by DC correlated testing.

AC Electrical Characteristics (Note 5)

CD4011BC: $T_A = 25^\circ\text{C}$, Input t_r ; $t_f = 20$ ns. $C_L = 50$ pF, $R_L = 200\text{k}$. Typical Temperature Coefficient is $0.3\%/^\circ\text{C}$.

Symbol	Parameter	Conditions	Typ	Max	Units
t_{PHL}	Propagation Delay, HIGH-to-LOW Level	$V_{DD} = 5\text{V}$ $V_{DD} = 10\text{V}$ $V_{DD} = 15\text{V}$	120 50 35	250 100 70	ns
t_{PLH}	Propagation Delay, LOW-to-HIGH Level	$V_{DD} = 5\text{V}$ $V_{DD} = 10\text{V}$ $V_{DD} = 15\text{V}$	85 40 30	250 100 70	ns
t_{THL}, t_{TLH}	Transition Time	$V_{DD} = 5\text{V}$ $V_{DD} = 10\text{V}$ $V_{DD} = 15\text{V}$	90 50 40	200 100 80	ns
C_{IN}	Average Input Capacitance	Any Input	5	7.5	pF
C_{PD}	Power Dissipation Capacity	Any Gate	14		pF

Note 5: AC Parameters are guaranteed by DC correlated testing.

Typical Performance Characteristics

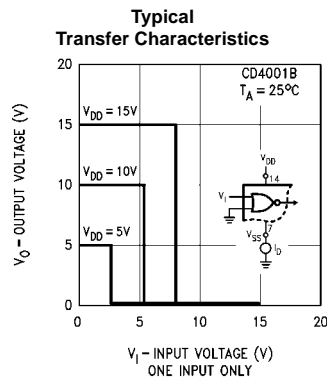
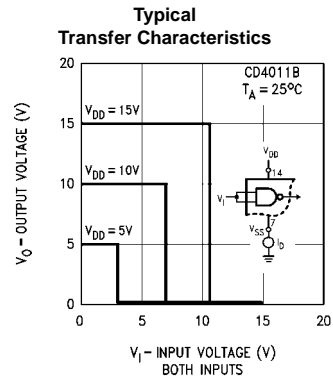
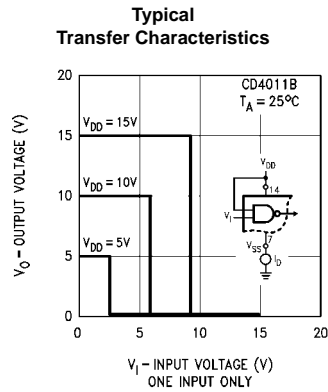

Typical Performance Characteristics (Continued)

Typical Transfer Characteristics

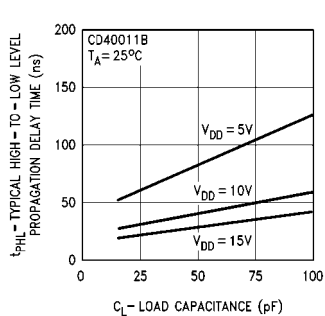
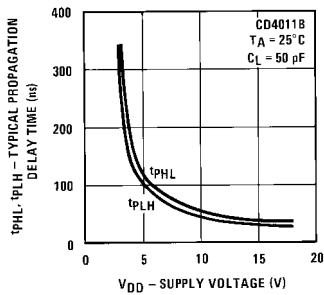
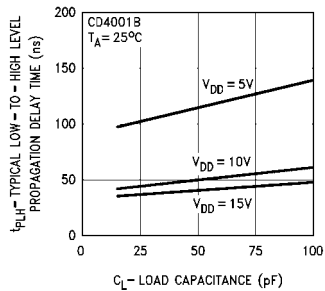
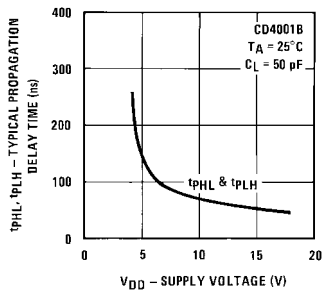
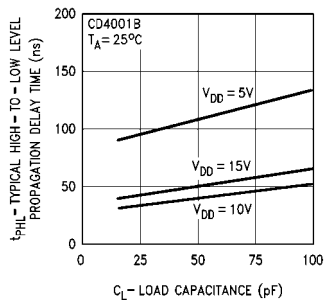
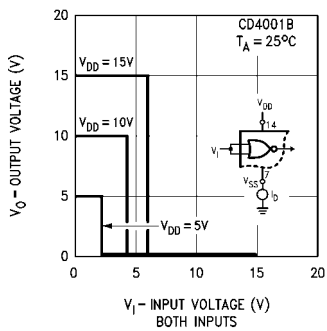

Typical Performance Characteristics (Continued)

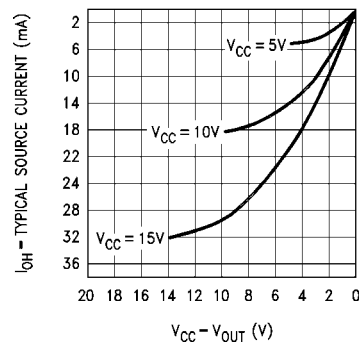
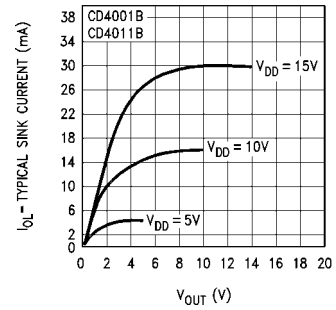
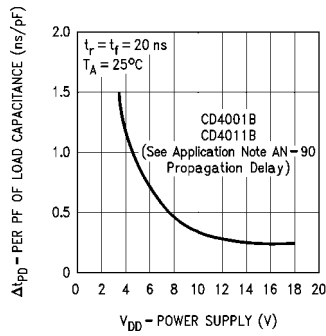
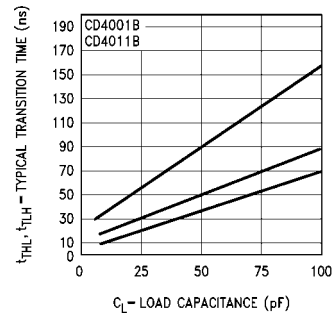
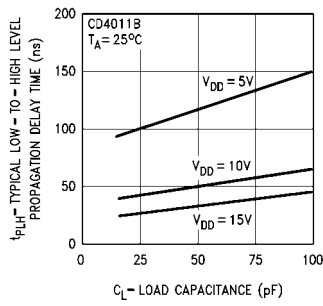

Physical Dimensions inches (millimeters) unless otherwise noted



14-Lead Small Outline Integrated Circuit (SOIC), JEDEC MS-012, 0.150" Narrow Package Number M14A

Physical Dimensions inches (millimeters) unless otherwise noted (Continued)

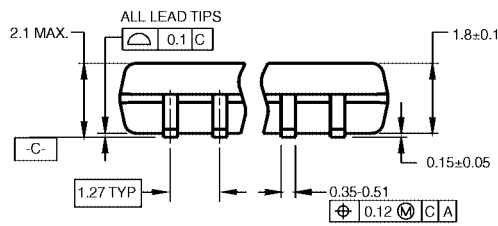
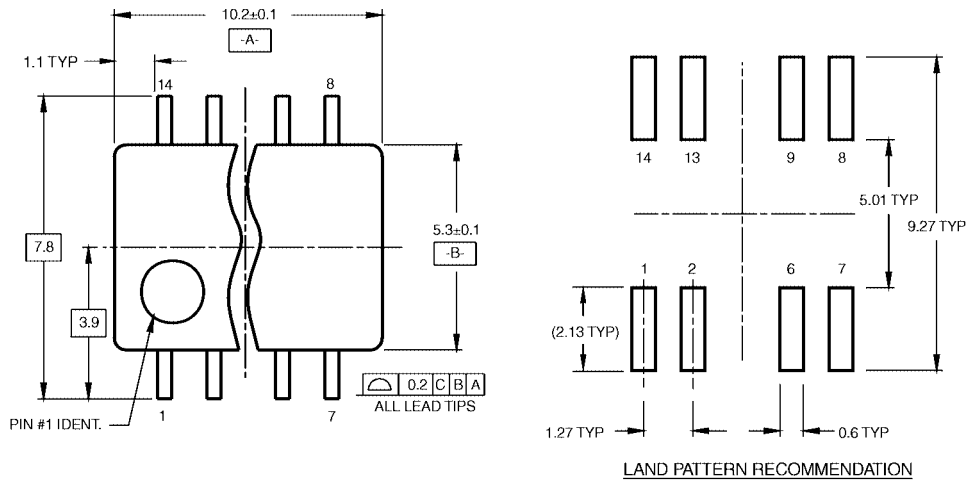

DIMENSIONS ARE IN MILLIMETERS

- NOTES:
 A. CONFORMS TO EIAJ EDR-7320 REGISTRATION, ESTABLISHED IN DECEMBER, 1998.
 B. DIMENSIONS ARE IN MILLIMETERS.
 C. DIMENSIONS ARE EXCLUSIVE OF BURRS, MOLD FLASH, AND TIE BAR EXTRUSIONS.

M14DRevB1

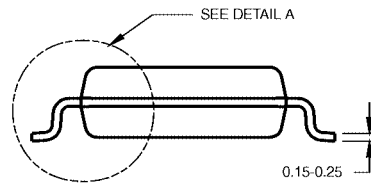

**14-Lead Small Outline Package (SOP), EIAJ TYPE II, 5.3mm Wide
 Package Number M14D**

Physical Dimensions inches (millimeters) unless otherwise noted (Continued)

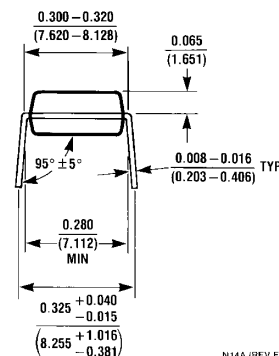
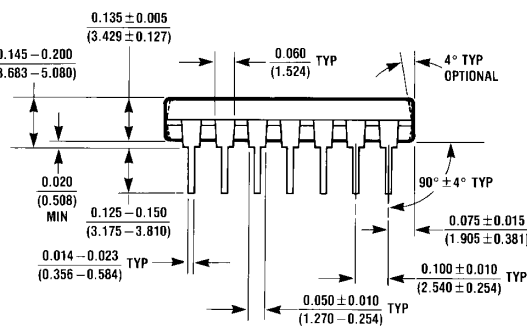
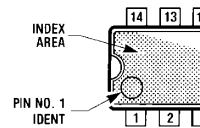
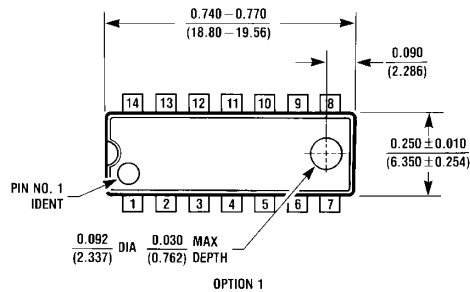

N14A (REV F)

14-Lead Plastic Dual-In-Line Package (PDIP), JEDEC MS-001, 0.300" Wide Package Number N14A

Fairchild does not assume any responsibility for use of any circuitry described, no circuit patent licenses are implied and Fairchild reserves the right at any time without notice to change said circuitry and specifications.

LIFE SUPPORT POLICY

FAIRCHILD'S PRODUCTS ARE NOT AUTHORIZED FOR USE AS CRITICAL COMPONENTS IN LIFE SUPPORT DEVICES OR SYSTEMS WITHOUT THE EXPRESS WRITTEN APPROVAL OF THE PRESIDENT OF FAIRCHILD SEMICONDUCTOR CORPORATION. As used herein:

1. Life support devices or systems are devices or systems which, (a) are intended for surgical implant into the body, or (b) support or sustain life, and (c) whose failure to perform when properly used in accordance with instructions for use provided in the labeling, can be reasonably expected to result in a significant injury to the user.
2. A critical component in any component of a life support device or system whose failure to perform can be reasonably expected to cause the failure of the life support device or system, or to affect its safety or effectiveness.

www.fairchildsemi.com

Mouser Electronics

Authorized Distributor

Click to View Pricing, Inventory, Delivery & Lifecycle Information:

ON Semiconductor:

[CD4001BCSJ_Q](#) [CD4001BCSJX_Q](#) [CD4001BCSJX](#) [CD4001BCM](#) [CD4001BCN](#) [CD4001BCSJ](#) [CD4001BCM](#)
[CD4001BCN_Q](#)