

S&E-ASTR-S-101-69  
June 25, 1969



# TECHNICAL INFORMATION SUMMARY APOLLO-11 (AS-506)

## APOLLO SATURN V SPACE VEHICLE

FACILITY FORM #

AS-506-21012  
(ACQUISITION NUMBER)

69  
(PAGE)

TAX # 62812  
(NASA OR ON TMX OR AS NUMBER)

(TRU)

1  
(CODE)

31  
(CATEGORY)

PREPARED BY:  
S&E-ASTR-S  
S&E-ASTN-ESD  
S&E-AERO-P

NATIONAL AERONAUTICS AND SPACE ADMINISTRATION



54258911

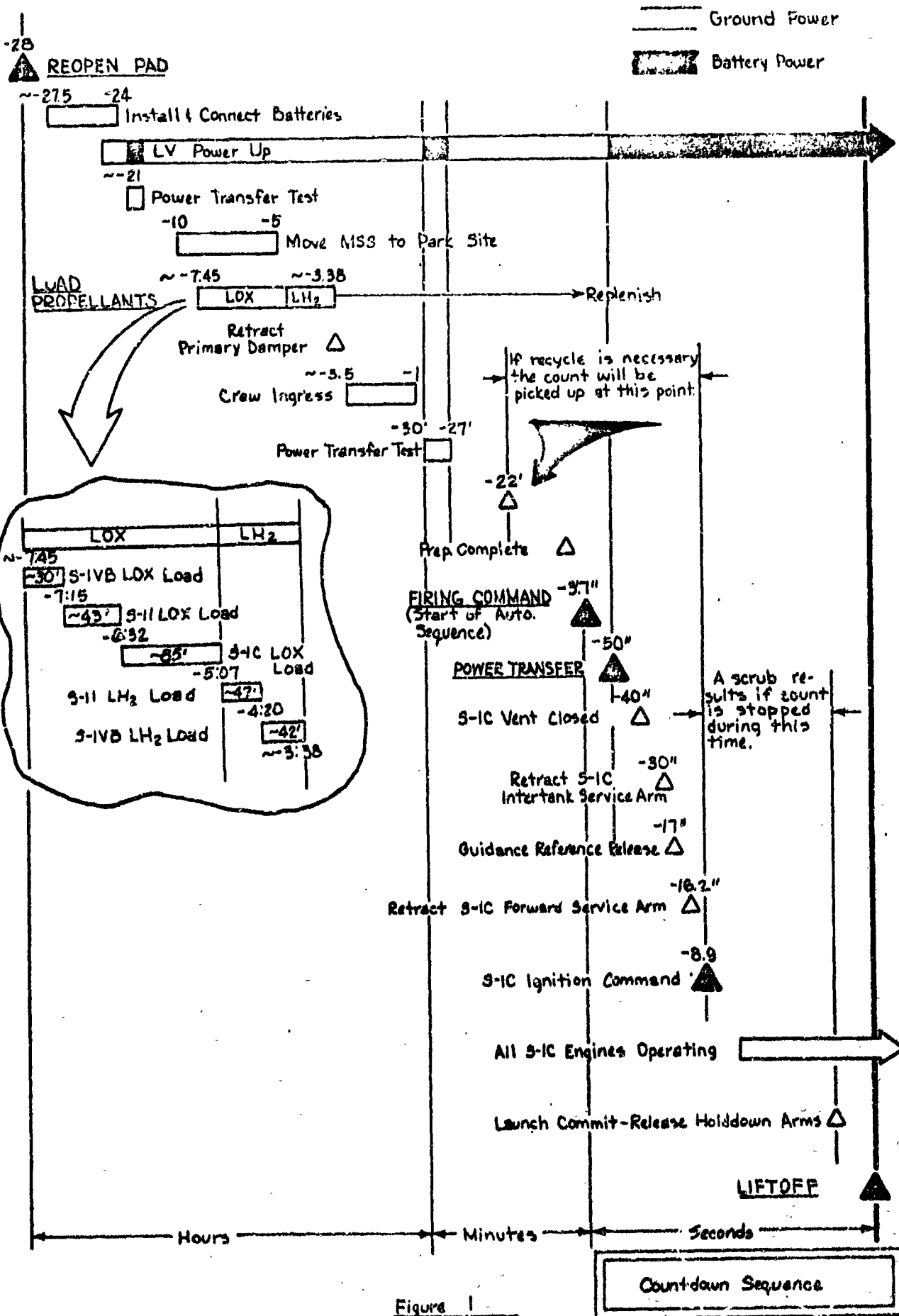

ABBREVIATIONS AND ACRONYMS

ac (AC)	Alternating Current	H <sub>2</sub>	Hydrogen
Accel	Accelerometer	He	Helium
AM	Amplitude Modulation	HP	High Pressure
amp	Ampere	HOSC	Huntsville Operations Support Center
APS	Auxiliary Propulsion System	Hr	Hour
AUTO	Automatic	Hz	Hertz (one cycle per second)
C.O.	Cutoff	IBM	International Business Machines
CCW	Counterclockwise	IGM	Interactive Guidance Mode
CCS	Command Communication System	in	Inch
CECO	Center Engine Cutoff	IU	Instrument Unit
CG	Center of Gravity	J-2	S-IVB & S-II Engines
CIF	Central Instrumentation Facility	KSC	Kennedy Space Center
CIU	Computer Interface Unit	Lat	Lateral
CM	Command Module	Lbs	Pounds
CSM	Command and Service Module	LCC	Launch Control Center
C-T	Crawler Transporter	LES	Launch Escape System
CW	Clockwise	LET	Launch Escape Tower
dc (DC)	Direct Current	LH <sub>2</sub>	Liquid Hydrogen
DCS	Digital Command System	LIEF	Launch Information Exchange Facility
DDAS	Digital Data Acquisition System	LM	Lunar Module
DEE	Digital Events Evaluation	L.O.	Liftoff
deg	Degree	LOR	Lunar Orbital Rendezvous
Dia	Diameter	LOX	Liquid Oxygen
EBW	Exploding Bridgewire	LV	Launch Vehicle
ECO	Engine Cutoff	LVDA	Launch Vehicle Data Adapter
ECS	Environmental Control Assembly	LVDC	Launch Vehicle Digital Computer
EDS	Emergency Detection System	Max	Maximum
EMR	Engine Mixture Ratio	Max "q"	Maximum dynamic pressure
Eng	Engine	Mech	Mechanical
Elec	Electric (Electrical)	MCC	Mission Control Center
EPO	Earth Parking Orbit	MDC	MacDonnel Douglas Corporation
EOM	End of Mission	MHz	Mega Hertz (1 Million Hertz)
ESE	Electrical Support Equipment	Min	Minute
EVA	Extra Vehicular Activity	Mod	Model
F-1	S-1C Engines	Mux	Multiplexer
FCC	Flight Control Computer	Misc	Miscellaneous
FM	Frequency Modulation	ML	Mobile Launcher
Fwd	Forward	MR	Mixture Ratio
GAEC	Grumman Aircraft Engr. Corp.	MSC	Manned Spacecraft Center
Gal	Gallon (s)	MSFC	Marshall Space Flight Center
GN <sub>2</sub>	Gaseous Nitrogen	MSFN	Manned Space Flight Network
GOX	Gaseous Oxygen	MSS	Mobile Service Structure
Gpm	Gallon per minute		
GRR	Guidance Reference Release		
GSE	Ground Support Equipment		
GHe	Gaseous Helium		
GUID	Guidance		

ABBREVIATIONS AND ACRONYMS (Cont'd)

NAR	North American Rockwell	USB	Unified S-Band
NASA	National Aeronautics and Space Administration	Vel	Velocity
No	Number	vac	Volts, alternating current
NMI (n.mi.)	Nautical Mile	VAB	Vehicle Assembly Building
OAT	Overall Test Equipment	vdc	Volts, Direct Current
OECO	Outboard Engine Cutoff	VHF	Very High Frequency (30-300 MHz)
O <sub>2</sub>	Oxygen		
P (p)	Pitch	Y (y)	Yaw
PAM	Pulse Amplitude Modulation		
PCM	Pulse Code Modulation	<u>Symbols</u>	
POGO	Undersirable Launch Vehicle Longitudinal Oscillations	Δ	Delta
POI	Parking Orbit Insertion	β	Thrust Vector Angular Deflection
Press	Pressure	Δv	Velocity Increment
Prep	Preparation	θ <sub>p</sub>	Vehicle Attitude, Pitch
psi	Pounds Per Square Inch	θ <sub>y</sub>	Vehicle Attitude, Yaw
Psig	Pounds per sq. in. (gravity)	θ <sub>r</sub>	Vehicle Attitude, Roll
Psia	Pound per sq. in. (absolute)	θ̇ <sub>p</sub>	Vehicle Attitude Rate, Pitch
PU	Propellant Utilization	θ̇ <sub>y</sub>	Vehicle Attitude Rate, Yaw
		θ̇ <sub>r</sub>	Vehicle Attitude Rate, Roll
R (r)	Roll		
RCA	Radio Corp. of America		
RCS	Reaction Control System		
RF	Radio Frequency		
PJ-1	Ramjet Fuel (used for S-1C Hydro Fluid)		
RP-1	S-1C Propellant		
RPM	Revolutions per minute		
RSO	Range Safety Officer		
S/C	Spacecraft		
Sec	Second		
SEP	Separation		
SLA	Spacecraft Lunar Module Adapter		
SM	Service Module		
SPS	Service Module Propulsion System		
Sys	System		
T	(with subscript) Time Base		
TBC	The Boeing Company		
TD&E	Transportation, Docking and Ejection		
Temp	Temperature		
T-	Used in countdown, time left until launch		
TLI	Translunar Injection		
TM	Telemetry		
TV	Television		
TVC	Thrust Vector Control		

GENERAL INFORMATION

	<u>Page</u>
Abbreviations	2
List of Figures	4
Mission Summary	6
Distribution List	92

LIST OF FIGURES

<u>Figure</u>	<u>Title</u>	<u>Page</u>
<u>GENERAL</u>		
1	Countdown Sequence . . . . .	1
2	Mission Profile . . . . .	9
3	Trajectory Information -- Boost to TLI . . . . .	10
4	Lunar Descent and Ascent Phases . . . . .	12
5	Spacecraft Re-entry and Splashdown . . . . .	14
6	Space Vehicle . . . . .	15
7	KSC -- Launch Complex 39 . . . . .	17
8	Mobile Launcher . . . . .	19
9	Integrated Launch ESE . . . . .	21
<u>SPACE VEHICLE</u>		
10	S-IC/S-II Stage Flight Sequencing . . . . .	22
11	S-II/S-IVB Stage Flight Sequencing . . . . .	23
12	S-IVB Stage Flight Sequencing . . . . .	24
13	S-IVB Stage Flight Sequencing . . . . .	25
14	Alternate Time Base Sequencing . . . . .	26
15	Guidance and Control System . . . . .	28
16	Emergency Detection System . . . . .	31
17	Secure Range Safety System . . . . .	33
18	Typical LV Stage Measuring System . . . . .	34
19	Measurement Summary . . . . .	35
20	Vehicle Tracking Systems . . . . .	37
21	Space Vehicle Weight vs Flight Time . . . . .	39
<u>S-IC STAGE</u>		
22	S-IC Configuration . . . . .	41
23	S-IC F-1 Engine System . . . . .	43
24	S-IC Propellant System . . . . .	45
25	S-IC Thrust Vector Control System . . . . .	47
26	S-IC Electrical Power and Distribution System . . . . .	48
27	S-IC Telemetry System . . . . .	49
<u>S-II STAGE</u>		
28	S-II Configuration . . . . .	51
29	S-II J-2 Engine System . . . . .	53
30	S-II Propellant System . . . . .	55
31	S-II Thrust Vector Control System . . . . .	57
32	S-II Propellant Management System . . . . .	59

LIST OF FIGURES (Continued)

<u>Figure</u>	<u>Title</u>	<u>Page</u>
<u>S-II STAGE (Continued)</u>		
33	S-II Electrical Power and Distribution System . . . . .	60
34	S-II Telemetry System . . . . .	61
<u>S-IVB STAGE</u>		
35	S-IVB Configuration . . . . .	63
36	S-IVB J-2 Engine System . . . . .	65
37	S-IVB Propellant System . . . . .	67
38	S-IVB Thrust Vector Control System . . . . .	69
39	Auxiliary Propulsion System . . . . .	71
40	S-IVB Propellant Management System . . . . .	73
41	S-IVB Electrical Power and Distribution System . . . . .	74
42	S-IVB Telemetry System . . . . .	75
<u>INSTRUMENT UNIT</u>		
43	Instrument Unit Configuration . . . . .	77
44	Instrument Unit Electrical Power and Distribution System . . . . .	78
45	Instrument Unit Telemetry System . . . . .	79
46	IU/S-IVB Environmental Control System . . . . .	81
<u>SPACECRAFT</u>		
47	Spacecraft Configuration . . . . .	83
48	Spacecraft Guidance and Navigation System . . . . .	84
49	Spacecraft Electrical Power and Distribution System . . . . .	85
50	Command Module (CM) . . . . .	86
51	CM Telecommunication System . . . . .	87
52	Lunar Module (LM) . . . . .	88
53	LM Guidance and Navigation Section . . . . .	89
54	LM Communications Subsystem . . . . .	90
55	Lunar Surface Communication . . . . .	91

AS-506

MISSION SUMMARY

This document is prepared jointly by the Marshall Space Flight Center Laboratories S&E-ASTR-S, S&E-AERO-P, and S&E-ASTN-ESD. The document presents a brief and concise description of the AS-506 Apollo Saturn Space Vehicle and the AS-506 mission. Where necessary, for clarification, additional related information has been included.

It is not intended that this document completely define the Space Vehicle, its systems or subsystems in detail. The information presented herein by text and sketches, describe launch preparation, ground support activities, and the space vehicle. This information permits the reader to follow the sequence of events beginning a few hours before liftoff to mission completion.

1. Mission Purpose:

AS-506, Apollo 11, Mission G-1, is the first manned Lunar Landing Mission. It uses Launch Vehicle SA-506; Command/Service Module 107, Lunar Module 5; Launch Complex 39A; Mobile Launcher #1 and LCC Firing Room #1. purpose is (1) to perform a successful lunar landing (2) assess the capabilities and limitations of the astronauts and their equipment in a lunar surface environment, (3) perform inspection of the lunar surface and obtain soil samples, and (4) to safely return the crew to earth. The crew consists of Neil A. Armstrong, Spacecraft Commander, Edwin E. Aldrin, Lunar Module Pilot, and Michael Collins, Command Module Pilot.

2. Launch Vehicle Objectives:

Demonstrate launch vehicle capability to inject the spacecraft onto a free-return, translunar trajectory.

3. Mission Description:

AS-506, (Apollo 11), has a flight duration of approximately 8 days.

The AS-506 mission profile, illustrated in Figures 2 through 5, consists of the following phases: Launch and boost to earth parking orbit, coast in earth parking orbit, translunar injection, translunar coast, S-IVB "slingshot", lunar orbit insertion, lunar module descent, lunar surface activities, lunar module ascent, transearth injection, transearth coast, reentry, splashdown and recovery.

Launch and Boost to Earth Parking Orbit (EPO). AS-506 will be launched from Kennedy Space Center, Complex 39A on a launch azimuth of 90° East of North. The launch days and the earliest liftoff time, for each day, for the month of July are:

<u>Day</u>	<u>Earliest Liftoff Time</u>	<u>Flight Azimuth</u>
July 16.	8:32 a.m. CDT	72° - 108°
July 18	10:30 a.m. CDT	89° - 108°
July 21	11:09 a.m. CDT	94° - 108°

As the vehicle rises from the launch pad, a yaw maneuver is executed to insure that the vehicle does not collide with the tower in the event of high winds or a single engine failure. Once tower clearance has been accomplished, a pitch and roll maneuver is initiated to achieve proper flight attitude and a flight azimuth orientation of between 72 and 108 degrees.

A successful boost sequence, as illustrated in Figure 3, will insert the S-IVB/IU/SC into a 100 NMI circular earth parking orbit.

Coast in Earth Parking Orbit (EPO). The vehicle will coast in earth parking orbit while space vehicle subsystems checkout is performed. Preparation for translunar injection takes place during this period. The reignition time and orbital position of the S-IVB injection burn will depend on lunar declination and upon the injection window opportunity to be selected. The first injection opportunity occurs midway through the second parking orbit revolution while the second opportunity occurs midway through the third revolution.

Translunar injection. Following the selection of one of the two injection opportunities described above, the S-IVB stage reignites to provide translunar injection. The nominal injection provides a free return trajectory to earth if the deboost to the lunar parking orbit is not initiated.

Translunar Coast. Shortly after translunar injection, the Transposition, Docking, and Extraction (TD&E) of the Command and Service Module (CSM) and the Lunar Module (LM) will take place. To initiate this maneuver, the CSM, assisted by the service module's reaction control system, will separate from the S-IVB. Spacecraft Lunar-Module Adapter (SLA) panels are then jettisoned to expose the docking mechanism of the lunar module. Following separation, the CSM will translate approximately 50 feet, pitch 180 degrees, roll 60 degrees and move to docking interface with the lunar module. As soon as the crew has completed verification that docking latches are engaged, and that CSM/LM tunnel pressure has been equalized, the LM/SLA attach points are severed and the LM is extracted and moved approximately 100 ft. from the S-IVB. During translunar coast (approximately 75 hours), mid-course corrections are made if required.

S-IVB "Slingshot". In order to minimize the probability of spacecraft and launch vehicle collision, and to avert S-IVB earth or lunar impact, a S-IVB "slingshot" procedure is executed. To initiate this maneuver, the launch vehicle (S-IVB/IU/SLA) will move to a predetermined attitude and execute a retrograde dump of residual propellants. This will reduce vehicle velocity by approximately 115 feet per second. Following retrograde propellant dumping, the S-IVB is "safed" by dumping the remaining propellants and gas from gas bottles through the latch-open, nonpropulsive vents. This velocity change in the S-IVB will perturb the S-IVB trajectory so that the vehicle will be influenced by the moon's gravitational field. This influence will increase velocity sufficiently so as to place the S-IVB/IU/SLA in solar orbit.

Lunar Orbit Insertion. Prior to lunar orbit insertion, the crew will check the LM for operational readiness and return to the CSM. If all conditions are "go", the Service Module (SM) propulsion system will be used to deboost the CSM/LM into a moon orbit ranging from 60 to 170 NMI above the moon's surface. Two orbits later, approximately four hours, the astronauts will circularize the orbit at 60 NMI.



Lunar Module Descent. Approximately fourteen hours later, two members of the three man crew, (Armstrong and Aldrin), will enter the LM through the connecting tunnel. Upon completion of a LM checkout, they will undock the LM and begin maneuvers which will take them to the moon's surface. Landing, via the lunar module descent propulsion system, will occur approximately 2-1/2 hours later. (The LM can hover like a helicopter for approximately 60 seconds to select the smoothest landing spot.) While separated, the astronauts will use the radio for communication using Code names "Snowcone" for the Command Module and "Haystack" for the Lunar Module. Present planning calls for lunar touchdown to occur at 3:21 p.m. CDT on July 20, 1969. The third crewman (Collins) will continue to orbit the moon in the CM.

Lunar Surface Activities. Following touchdown, Armstrong and Aldrin are to rest for approximately eight hours, then don their portable life support backpacks and make other necessary preparation to walk the moon's surface. At 1:09 a.m. CDT on July 21, 1969, Armstrong is to climb down a nine-step ladder and become the first man to plant his footsteps on the moon's surface. This activity is to be relayed live to television viewers on earth with Aldrin handling the TV camera. Armstrong will stroll alone for about half an hour, gathering a quick sample of lunar soil so that they won't come home empty-handed if they should have to make an early takeoff. Then Aldrin is to join Armstrong on the surface for approximately 2 hours during which they are to gather about 80 pounds of lunar rocks and soil and to set up a scientific experiments package which will transmit lunar data after the astronauts leave.

Lunar Module Ascent. After returning to the LM, the astronauts are to rest for nearly six hours. They will have been on the moon for approximately 21 hours and 30 minutes. The LM ascent stage is used to liftoff from the moon's surface and to fly a 3-hour and 30 minute rendezvous course to catch-up and link-up with the CM. Orbital plane changes, trim burns, or maneuvers required to achieve CSM/LM rendezvous are made with the LM reaction control system. As soon as CSM/LM docking has been accomplished, the two crew members, the lunar soil samples and the exposed film are transferred to the CSM and the LM is secured. Service module RCS is used to separate the CSM from the LM.

Transearth Injection and Coast. The SM propulsion system is used to boost the CSM out of lunar orbit. During transearth coast (approximately 64 hours) midcourse corrections are made if required.

Reentry, Splashdown and Recovery. The Command Module is separated from the Service Module prior to atmospheric reentry. The nominal range from reentry (400,000 feet) to splashdown is approximately 2000 miles. Splashdown will take place in the Pacific Ocean approximately 12:00 p.m. CDT July 24, 1969. Immediate recovery of the crew after splashdown has been arranged.

Quarantine Period. Upon recovery, the astronauts will be transferred to a special sealed van on the deck of the carrier for the sea-air-truck trip to the Manned Spacecraft Center in Houston, Texas. There they are to be quarantined with the lunar soil samples in a lunar receiving laboratory for 18 days. Doctors want to be certain they do not bring back any lunar germs.

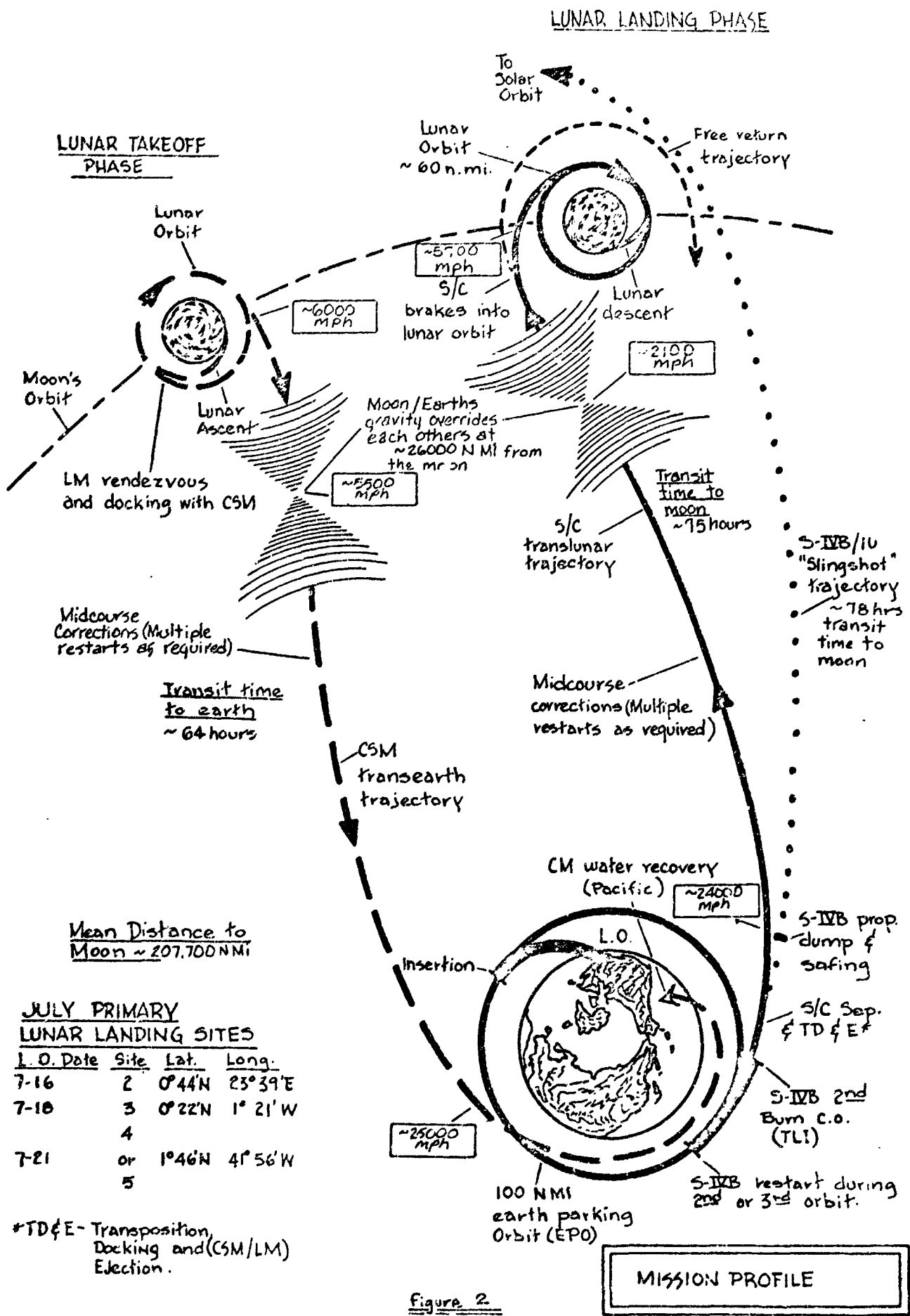

**LUNAR TAKEOFF PHASE**

**LUNAR LANDING PHASE**

Moon's Orbit

LM rendezvous and docking with CSM

Midcourse Corrections (Multiple restarts as required)

Transit time to earth ~ 64 hours

Mean Distance to Moon ~ 207,700 NMI

**JULY PRIMARY LUNAR LANDING SITES**

L.O. Date	Site	Lat.	Long.
7-16	2	0°44'N	23°39'E
7-18	3	0°22'N	1°21'W
	4		
7-21	or	1°46'N	4°56'W
	5		

\*TD&E - Transposition, Docking and (CSM/LM) Ejection.

**MISSION PROFILE**

Figure 2

# REPRODUCIBILITY OF THE ORIGINAL PAGE IS POOR

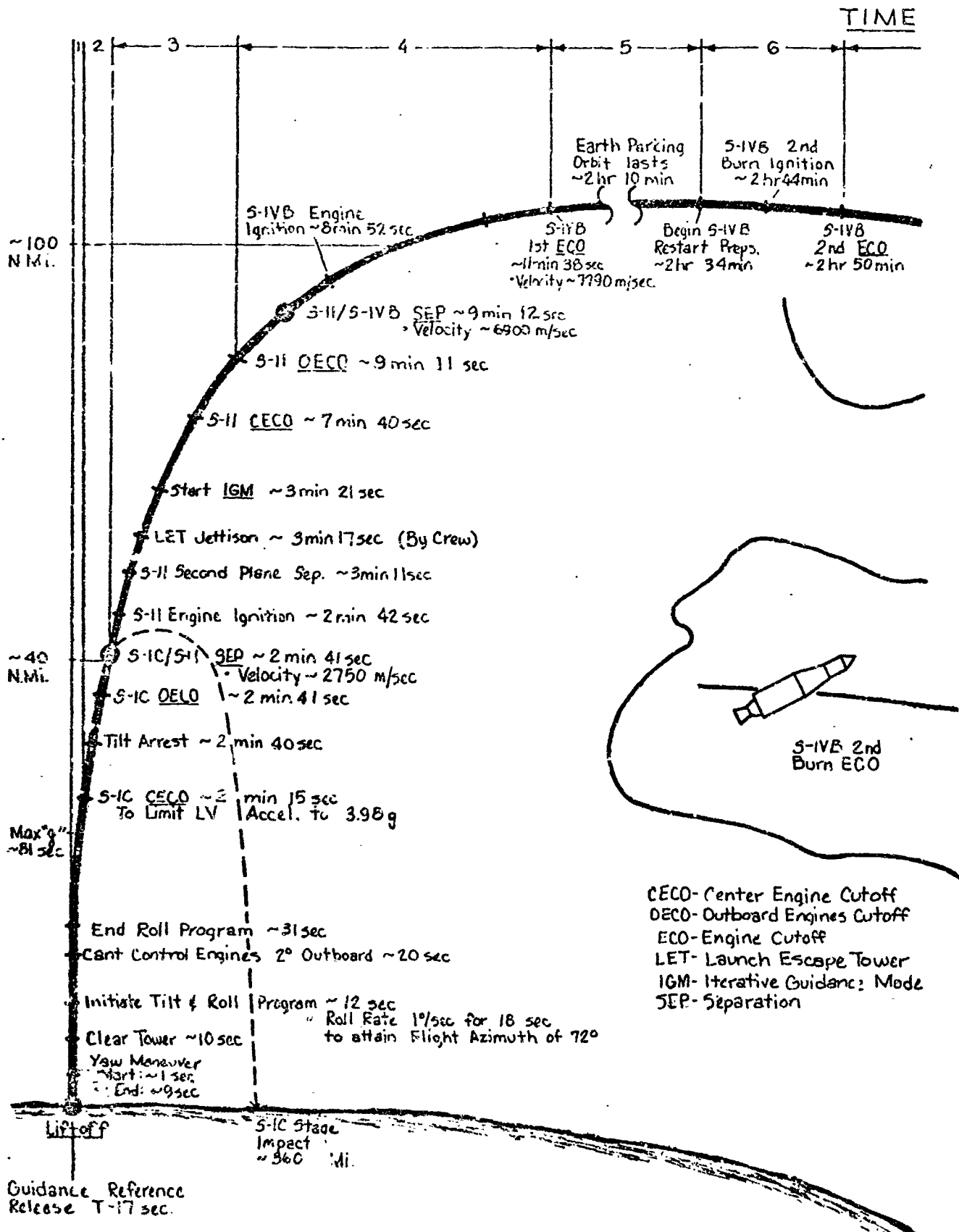

**LAUNCH DATA**

- Launch Complex 39 Pad A
- Launch Azimuth: 90° E of N
- Flight Azimuth: 72° E of N

ABOVE INFORMATION BASED UPON 72° FLIGHT AZIMUTH AND S-IVB 2nd IGNITION OCCURRING ON FIRST OPPORTUNITY

**BASES**

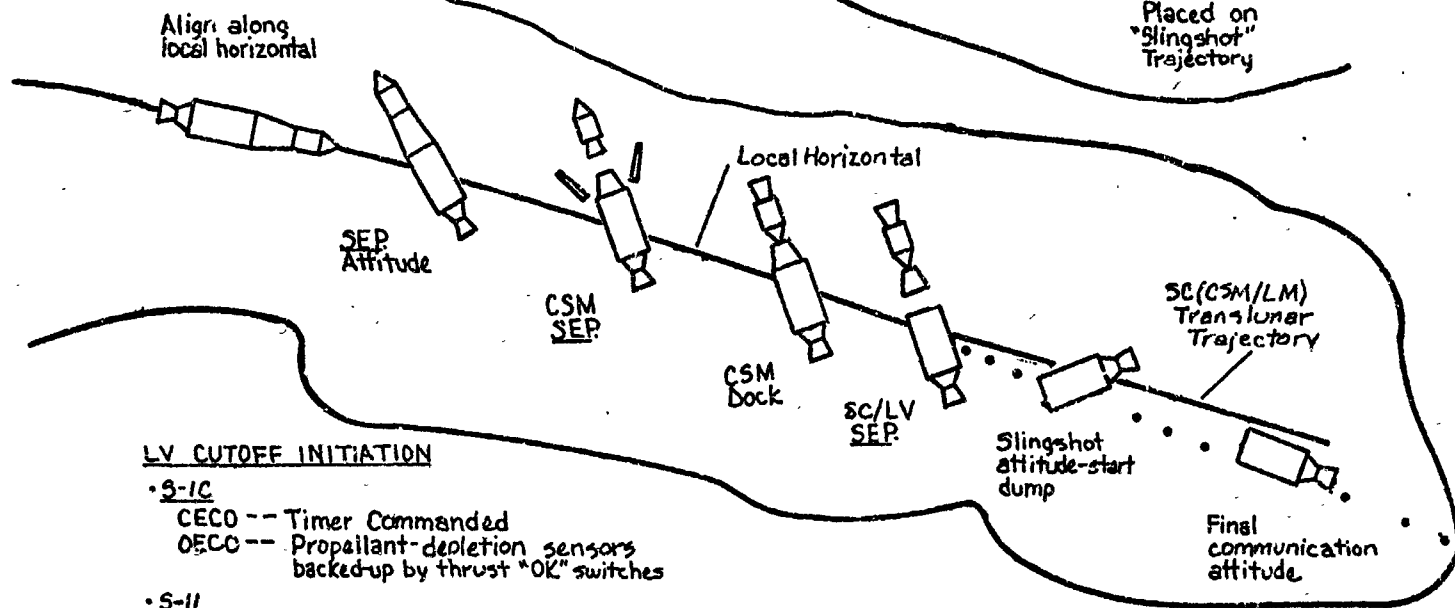
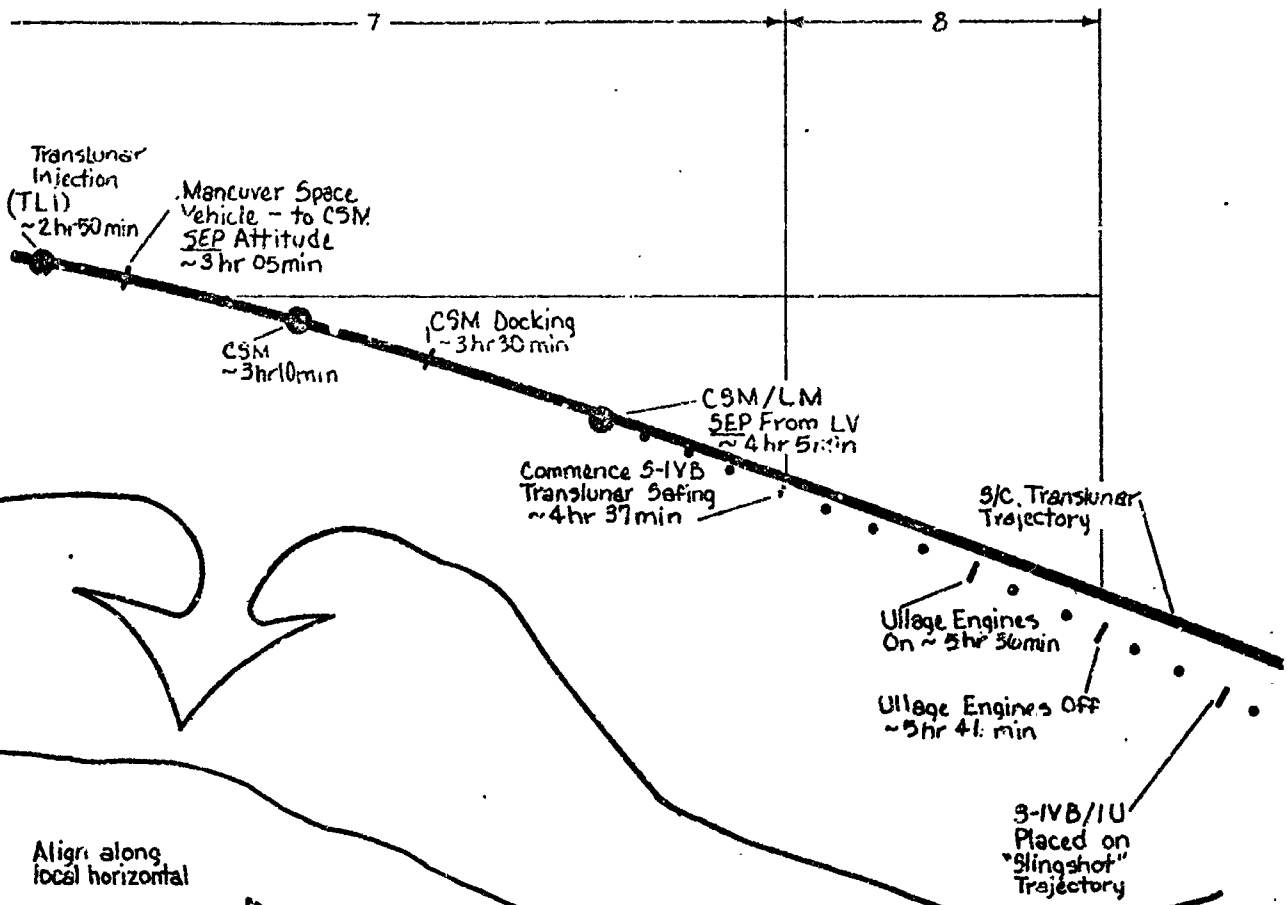

**LV CUTOFF INITIATION**

- **S-1C**  
 CECO -- Timer Commanded  
 OECO -- Propellant-depletion sensors backed-up by thrust "OK" switches
- **S-1I**  
 CECO -- Timer Commanded  
 OECO -- Propellant-depletion sensors backed-up by thrust "OK" switches
- **S-IVB**  
 1st Burn C.D. -- Velocity Cutoff backed-up by crew C.D. on overspeed  
 2nd Burn C.D. -- Velocity Cutoff backed-up by depletion sensors

Trajectory Information

Fig. 3

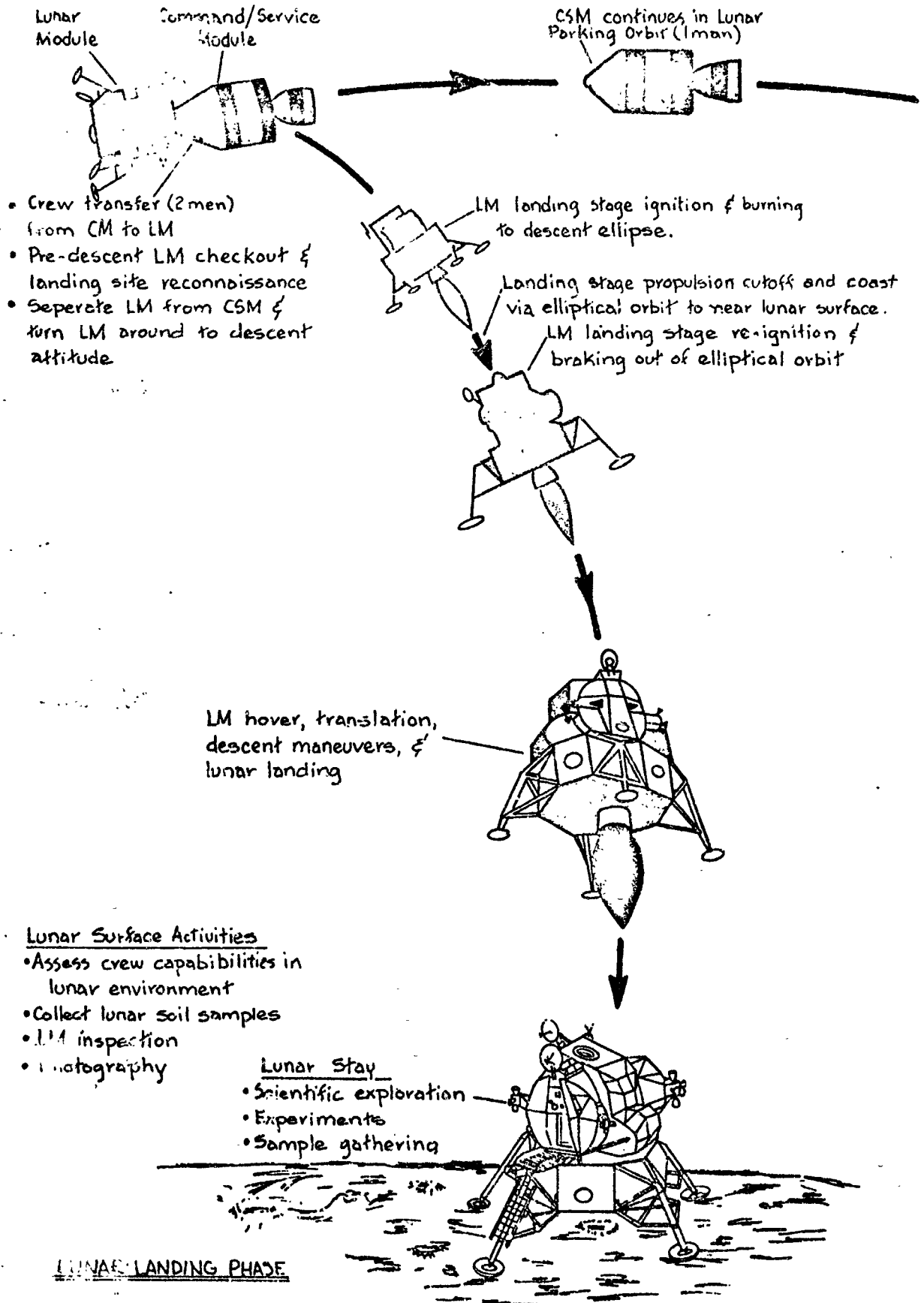

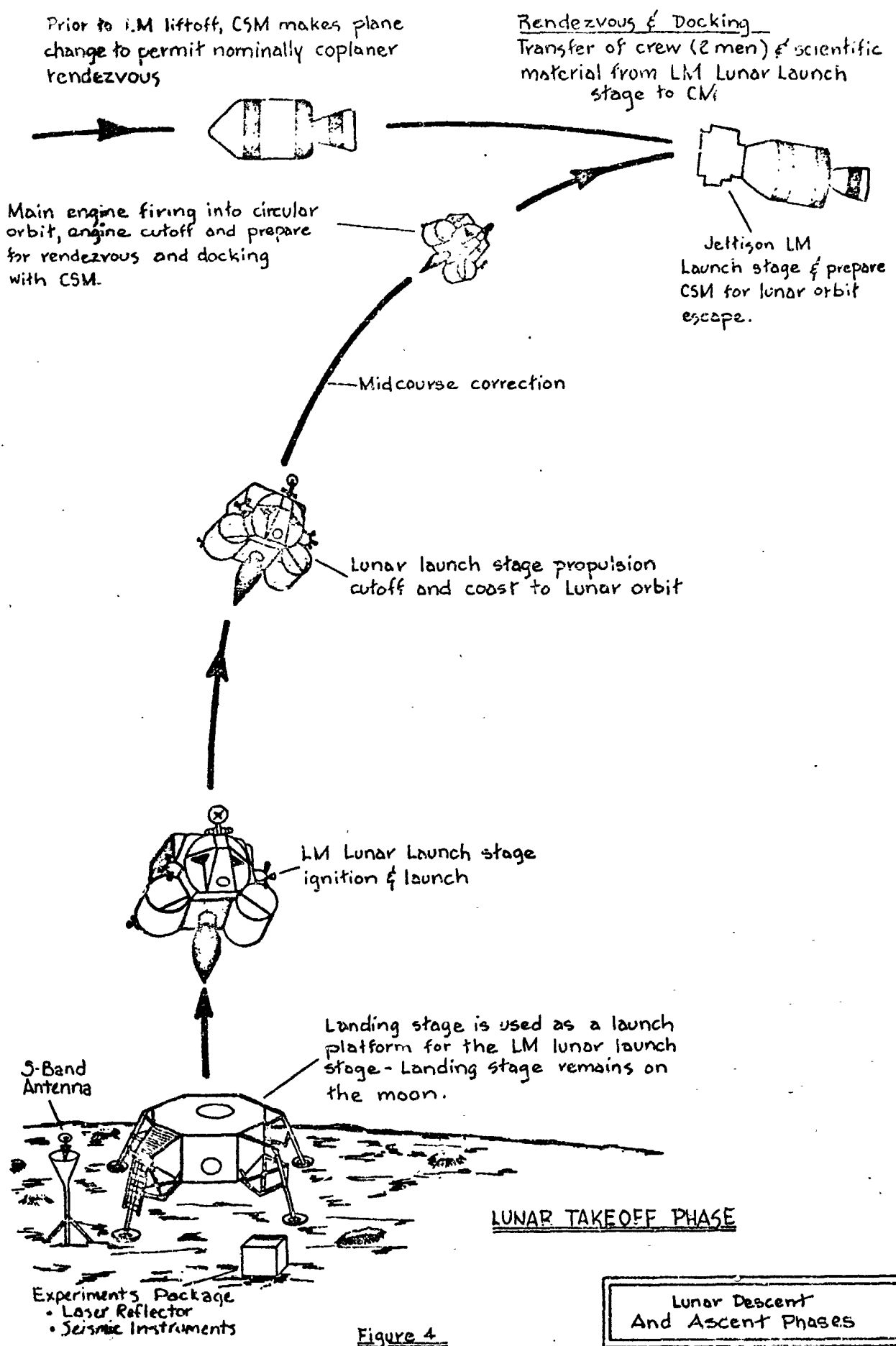
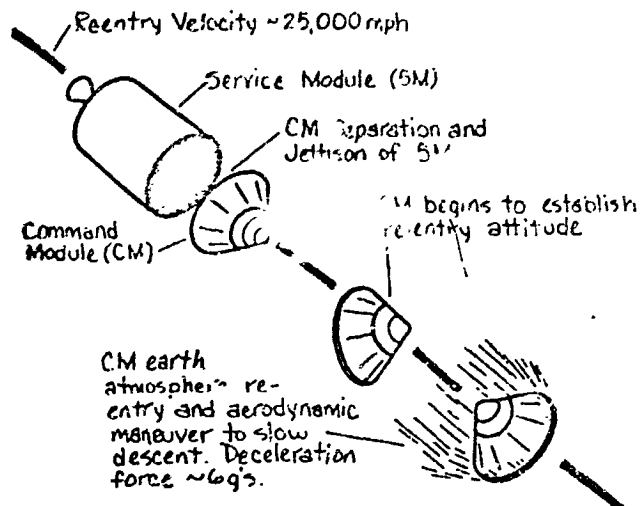
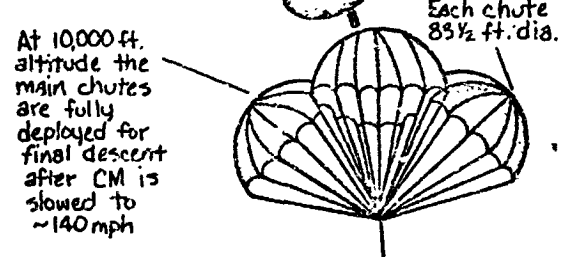
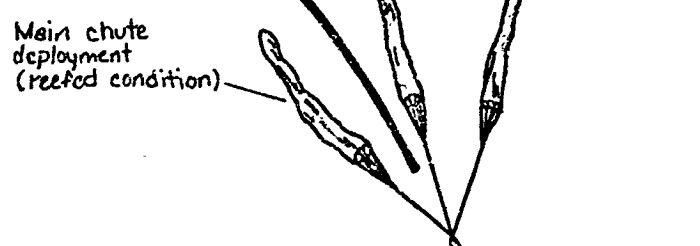
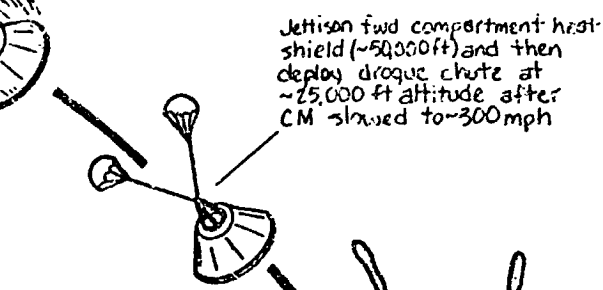

Figure 4

Lunar Descent  
 And Ascent Phases



Spacecraft is being guided to enter the earth's atmosphere in a corridor ~400 mi by 26 mi - If re-entry angle is too steep the SC will burn up; if too shallow SC will bounce back into space.



**NOTE:** The desired flotation mode after splashdown is with CM Apex Up

To achieve this mode, the flotation bags are released from the forward hatch causing the module to float upright

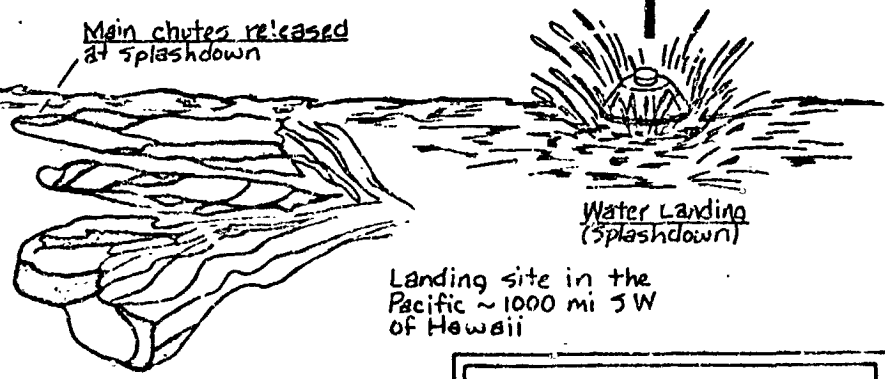
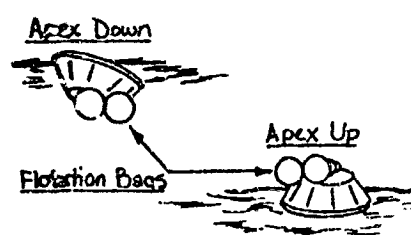

Spacecraft Re-entry & Splashdown

Figure 5

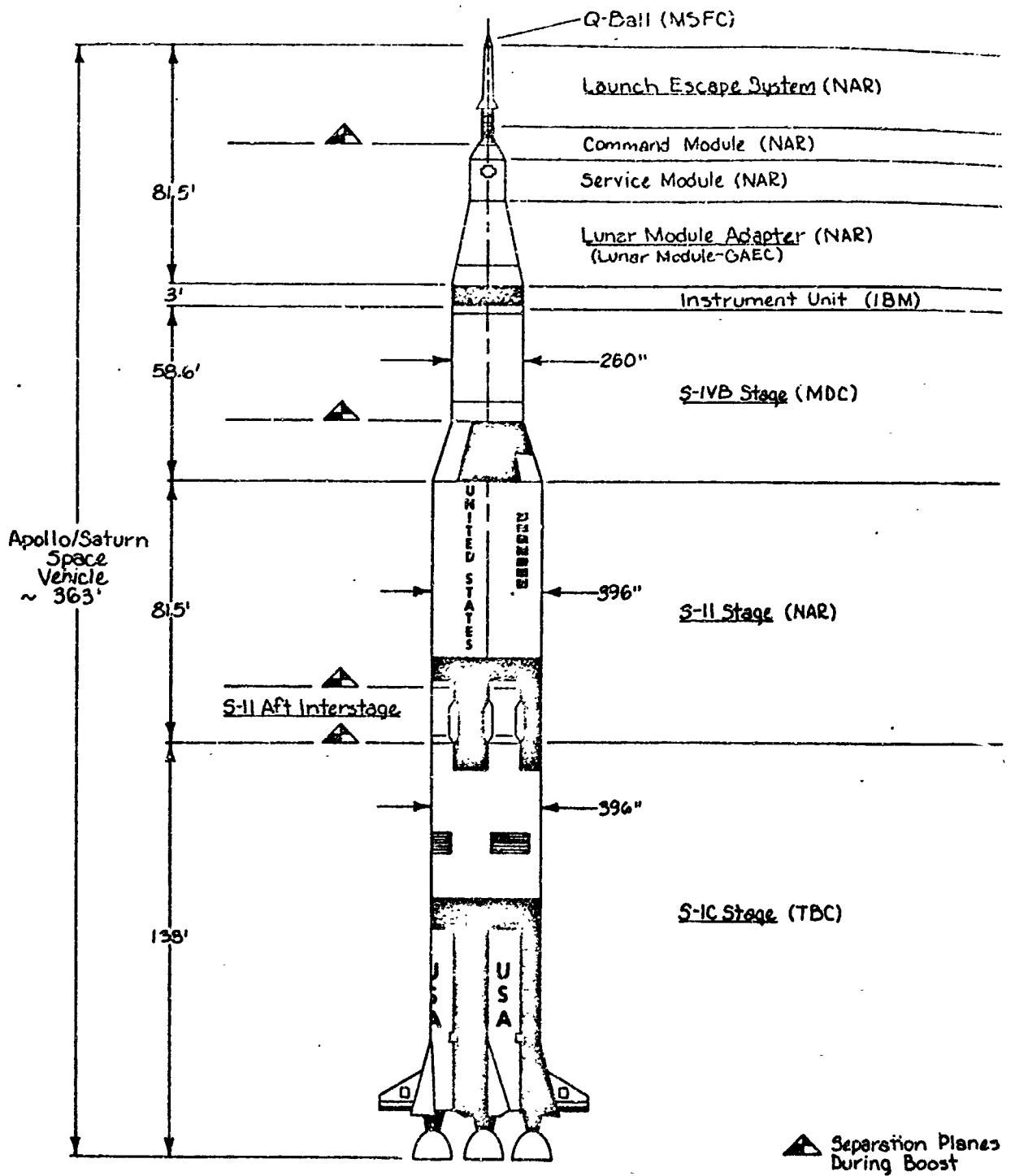

Figure 6

Space Vehicle



### LAUNCH COMPLEX 39

Launch Complex 39 (LC-39), Kennedy Space Center, Florida, provides all the facilities necessary for the assembly, checkout, and launch of the Apollo/Saturn space vehicle. The vehicle assembly building (VAB) provides a controlled environment in which the vehicle is assembled and checked out on a mobile launcher (ML). The space vehicle and the launch structure are then moved as a unit by the crawler-transporter (C-T) to the launch site, where vehicle launch is accomplished after propellant loading and final checkout. The major elements of the launch complex shown in Figure 7, are the vehicle assembly building (VAB), the launch control center (LCC), the mobile launcher (ML), the crawler-transporter (C-T), the crawlerway, the mobile service structure (MSS), and the launch pad.

# REPRODUCIBILITY OF THE ORIGINAL PAGE IS POOR

The Vehicle Assembly Building (VAB) and the Launch Control Center (LCC) are ~3 miles from the Launch Pads.

## The VAB

- The Low Bay Area is ~ 210 ft high by 442 ft wide by 274 ft long
- The High Bay Area is ~ 525 ft high by 518 ft wide by 442 ft long
- Has Controlled Environment

## The LCC is ~ 180 ft

- First Floor: Service and Support Area  
Complex Control Center
- Second Floor: Telemetry, RF and Tracking Equipment
- Third Floor: Firing and Mission Control Rooms
- Mezzanine - Direct Viewing of the Firing Rooms
- Fourth Floor: Launch Information Exchange Facility (LIEF), Display Area

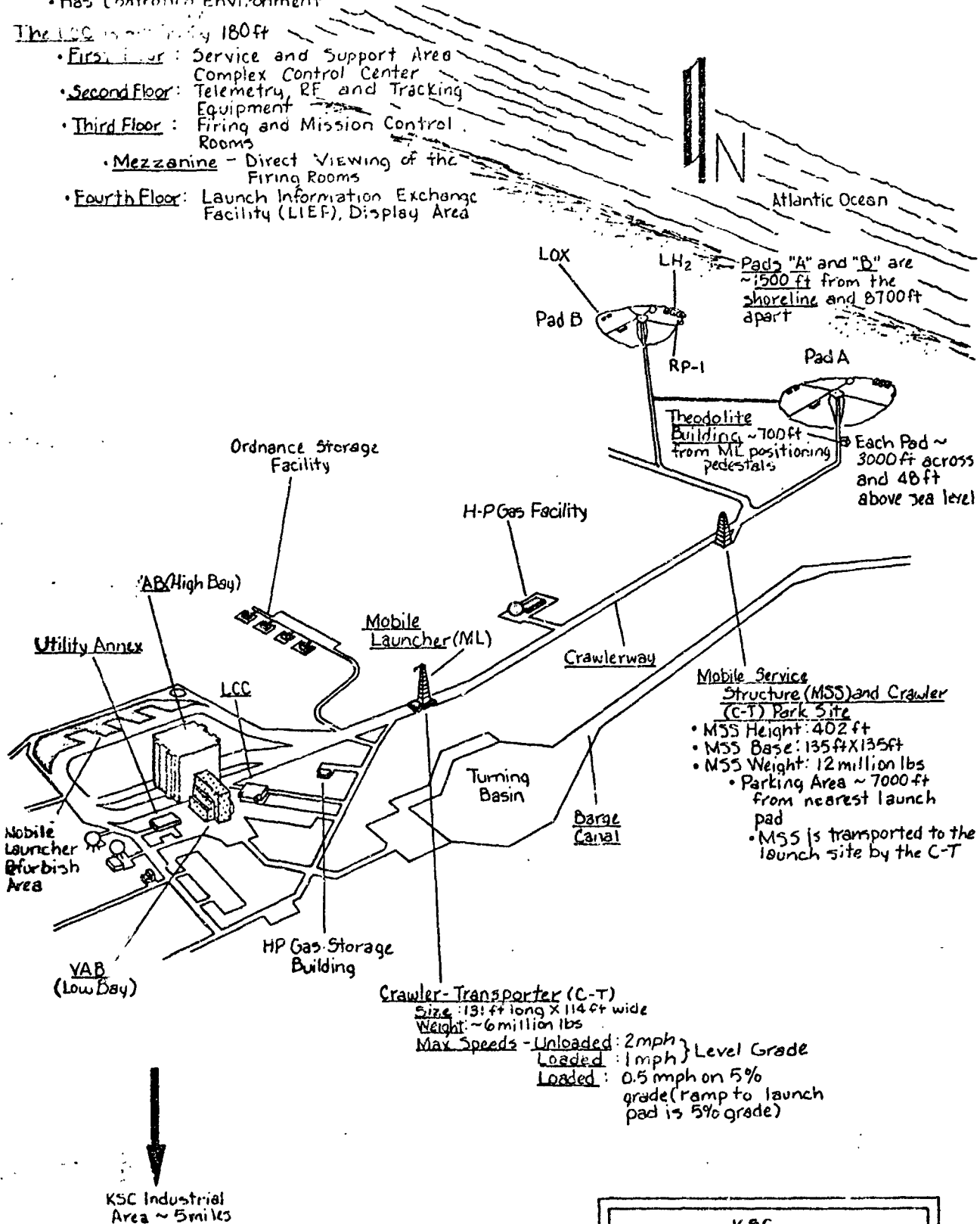

- Mobile Service Structure (MSS) and Crawler (C-T) Park Site**
- MSS Height: 402 ft
  - MSS Base: 135 ft X 135 ft
  - MSS Weight: 12 million lbs
  - Parking Area ~ 7000 ft from nearest launch pad
  - MSS is transported to the launch site by the C-T

**Crawler-Transporter (C-T)**  
 Size: 131 ft long X 114 ft wide  
 Weight: ~6 million lbs  
 Max Speeds - Unloaded: 2 mph } Level Grade  
 Loaded: 1 mph }  
 Loaded: 0.5 mph on 5% grade (ramp to launch pad is 5% grade)

KSC Industrial Area ~ 3 miles

KSC Launch Complex 39

Figure 7

## MOBILE LAUNCHER

The Mobile Launcher, figure 8, is a transportable steel structure which provides the capability of moving the erected vehicle to the launch pad via the crawler-transporter. The umbilical tower, permanently erected on the mobile launcher base, is a means of ready access to all important levels of the vehicle during assembly, checkout and servicing prior to launch. The intricate vehicle-ground interfaces are established and checked out within the protected environment of the Vertical Assembly Building (VAB) and then moved undisturbed aboard the mobile launcher to the launch pad.

- |  |   |
|--|---|
| <p>① S-IC Intertank (preflight). Provides LOX fill and drain. Arm may be reconnected to vehicle from LCC. Retract time 8 seconds. Reconnect time 5 minutes.</p>                                  | <p>⑥ S-IVB Forward (inflight). Provides LH<sub>2</sub> and LOX transfer, electrical, pneumatic, and air-conditioning interfaces. Retract time 7.7 seconds.</p>                      |
| <p>② S-IC Forward (preflight). Provides pneumatic, electrical, and air-conditioning interfaces. Retracted at T-16.2 seconds. Retract time 8 seconds.</p>   | <p>⑦ S-IVB Forward (inflight). Provides fuel tank vent, electrical, pneumatic, air-conditioning, and preflight conditioning interfaces. Retract time 8.4 seconds.</p>               |
| <p>③ S-II Aft (preflight). Provides access to vehicle. Retracted prior to liftoff as required.</p>   | <p>⑧ Service Module (inflight). Provides air-conditioning, vent line, coolant, electrical, and pneumatic interfaces. Retract time 9.0 seconds.</p>                                  |
| <p>④ S-II Intermediate (inflight). Provides LH<sub>2</sub> and LOX transfer, vent line, pneumatic, instrument cooling, electrical, and air-conditioning interface. Retract time 6.4 seconds.</p> | <p>⑨ Command Module Access Arm (preflight). Provide access to spacecraft through environmental chamber. Arm controlled from LCC. Retracted 12° park position until T-4 minutes.</p> |
| <p>⑤ S-II Forward (inflight). Provides GH<sub>2</sub> vent, electrical, and pneumatic interfaces. Retract time 7.4 seconds.</p>  |   |

Note:

Preflight arms are retracted and locked against umbilical tower prior to launch.

Inflight arms retract at vehicle liftoff on command from service arm control switches (located in hold-down arms).

Umbilical Tower

- Open Steel Structure
- Height: 380 ft
- Two high speed elevators service 18 landings, from level "A" of the base to the 340 ft tower level
- Provides support for eight umbilical service arms, one access arm, 18 work and access platforms, distribution equipment for the propellant, pneumatic, electrical and instrumentation subsystems, and other ground support equipment

Hammerhead Crane

- Launch position 90° CW from that shown below
- Load capacity 10 to 25 tons depending on extension of boom
- Can rotate 360° at 1rpm

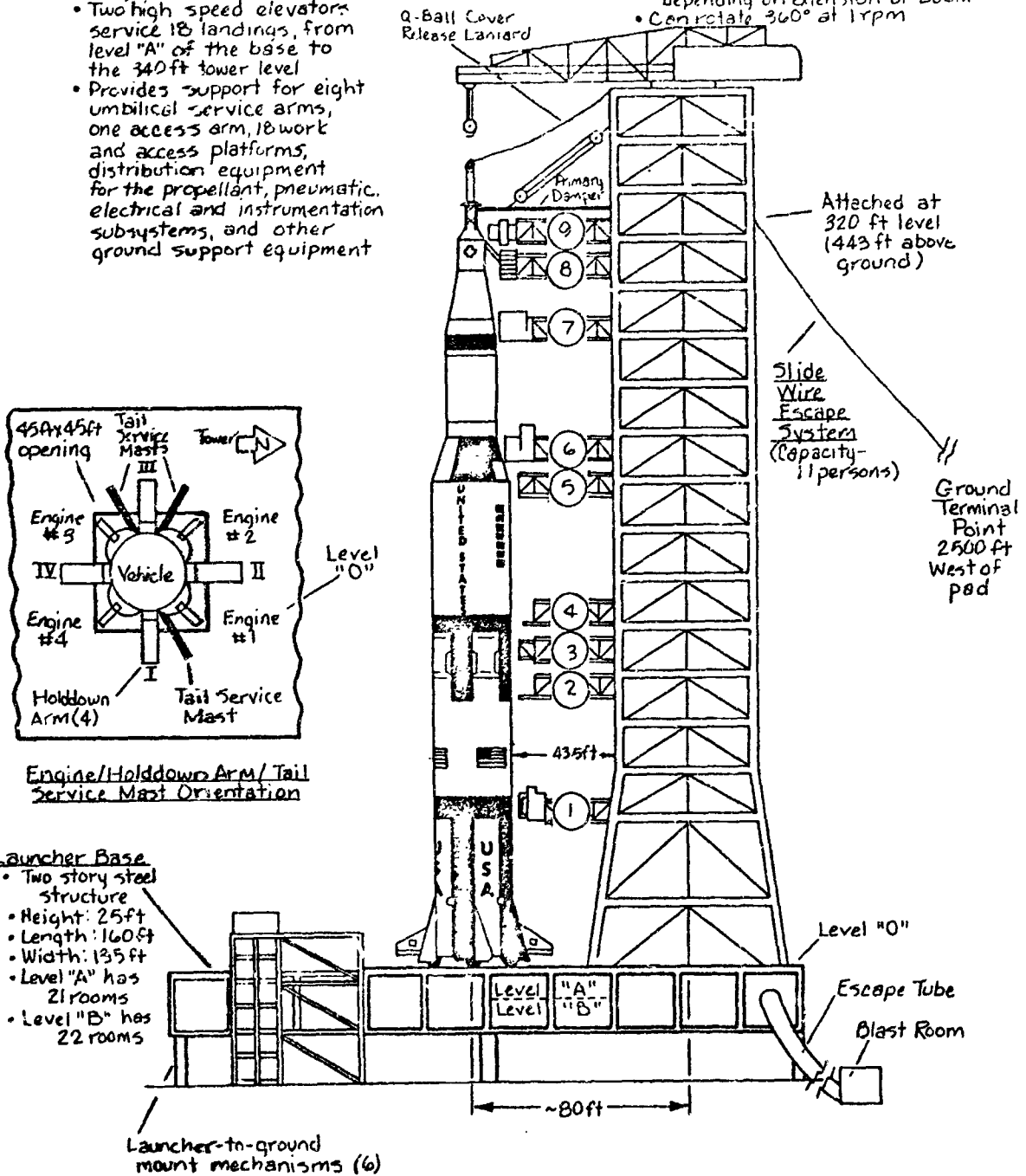

Engine/Holddowns Arm/Tail Service Mast Orientation

Launcher Base

- Two story steel structure
- Height: 25 ft
- Length: 160 ft
- Width: 135 ft
- Level "A" has 21 rooms
- Level "B" has 22 rooms

Figure 8

Mobile Launcher

## GROUND SUPPORT EQUIPMENT

A computer controlled automatic checkout system is used to accomplish checkout or testing of the launch vehicle when in the Vertical Assembly Building (VAB) highbay and on the launch pad.

An RCA 110A Computer and other equipment necessary for service and check out are installed with the vehicle on the mobile launcher. Similar equipment, joined by an integration system (relay network), a facilities cable tunnel and video cables for visual display are located in the Launch Control Center (LCC).

A Digital Data Acquisition System (DDAS) collects vehicle and support equipment responses to test commands and formulates test data for transmission, decommutation, and display to the LCC or ML.

Digital Events Evaluators (DEE) monitor the status of input lines and generate a time labeled printout for each detected change in input status. High speed printers in the LCC are connected to each DEE to provide a means for real time or post-test evaluation of discrete data.

The propellant tanking computer system (PTCS) determines and controls the quantities of fuel and oxidizer on board each stage. Optimum propellant levels are maintained and LOX and LH<sub>2</sub> are replenished as boiloff occurs during the countdown. The propellant tanking operation is monitored on the PTCS control panel.

Final countdown begins at T-102 hours. A countdown clock, located in the LCC, officially records this countdown.

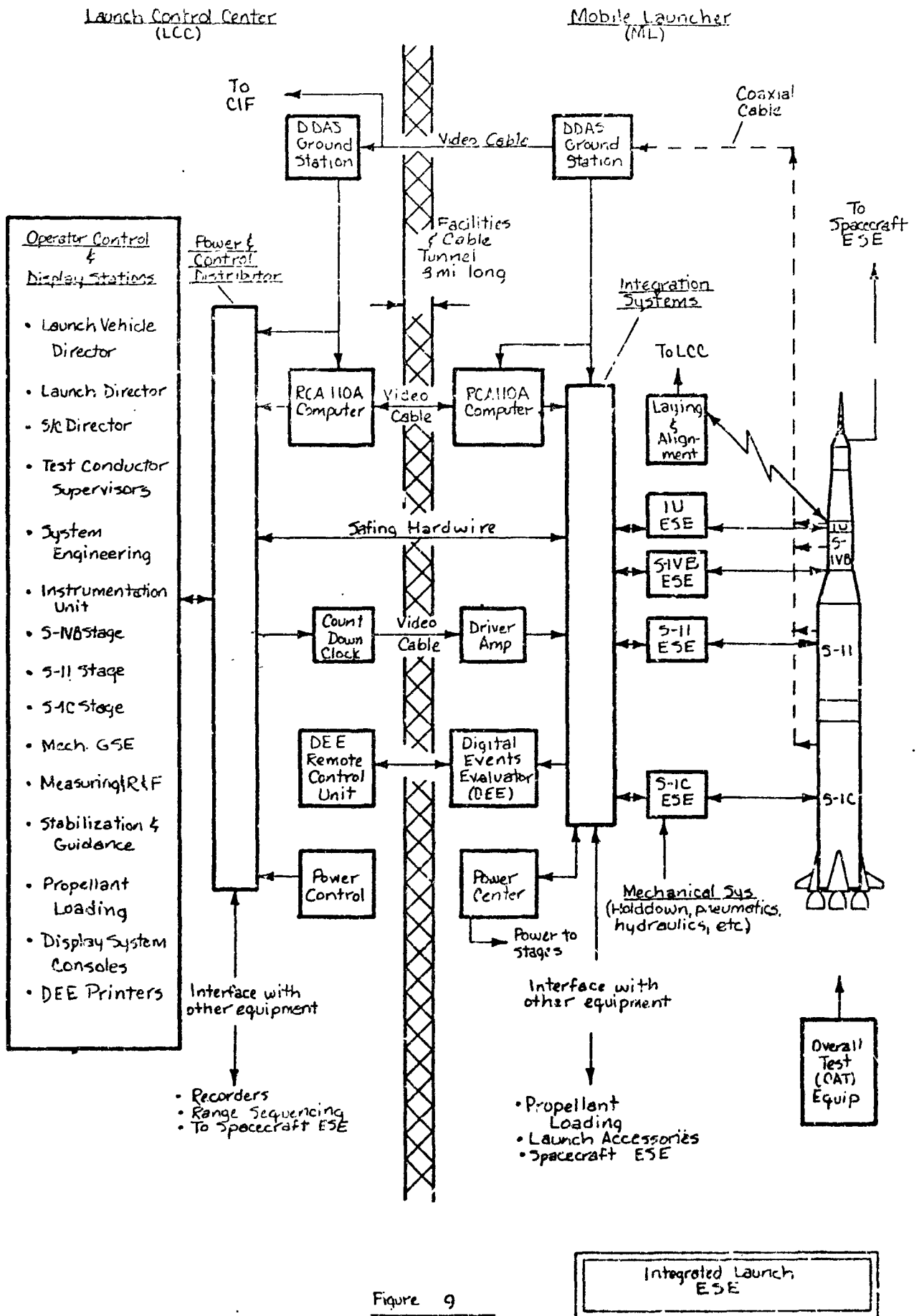

Figure 9

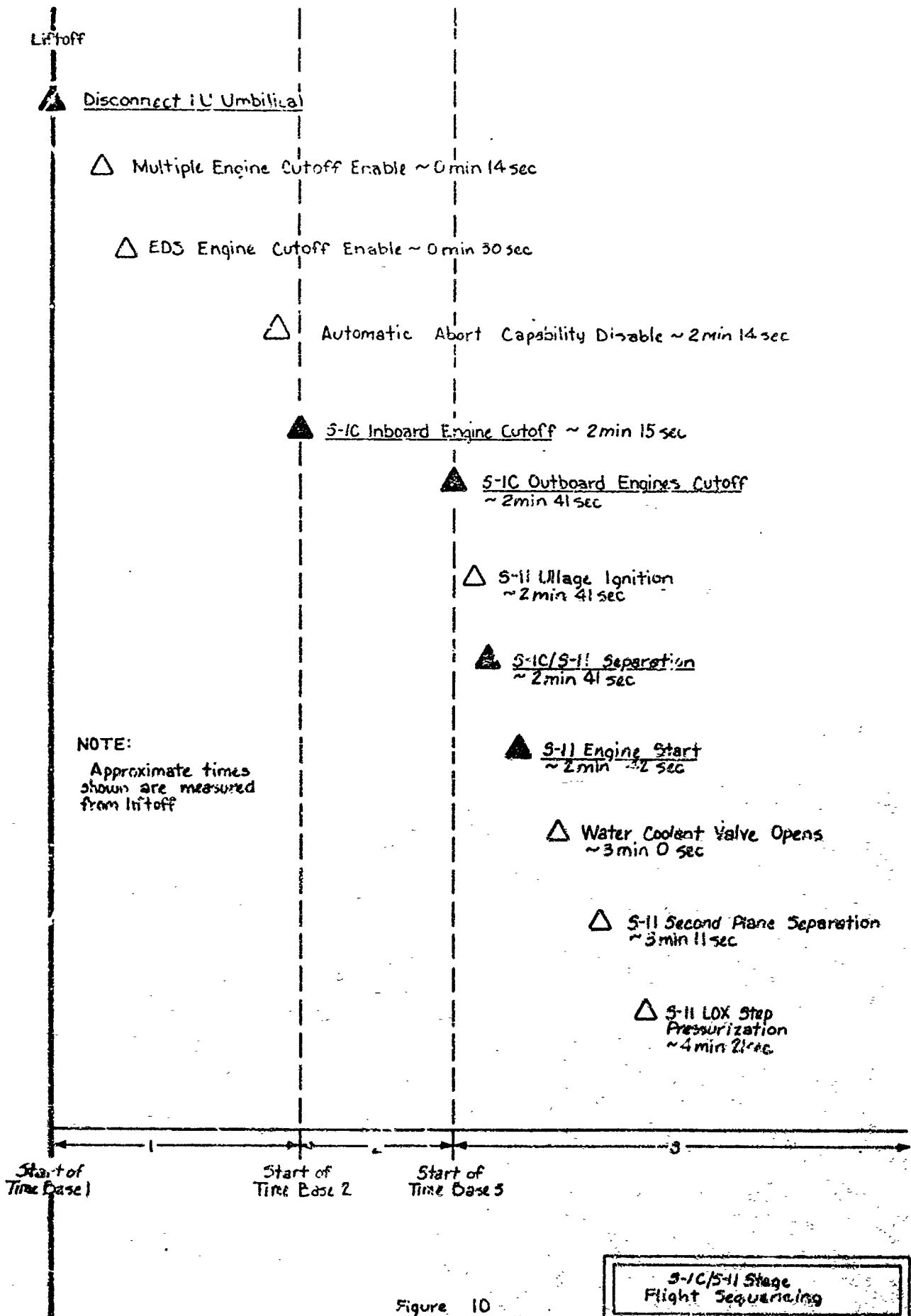
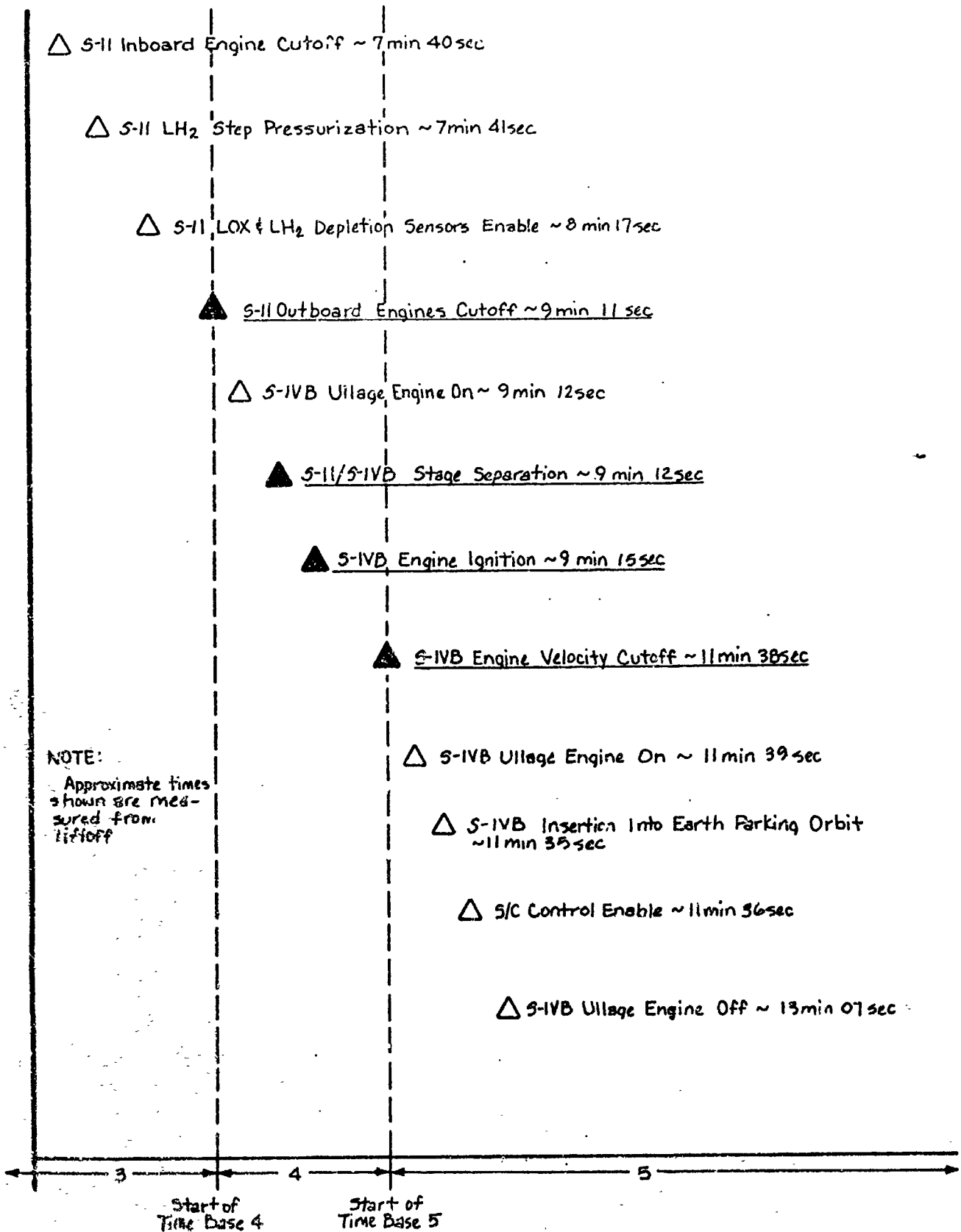

Figure 10



S-II/S-IVB Stage Flight Sequencing

Figure 11



▲ \* Begin S-IVB Stage Restart Preparations ~ 2 hr 34 min

△ S/C Control Disable ~ 2 hr 35 min

△ O<sub>2</sub>/H<sub>2</sub> Burner On ~ 2 hr 35 min

△ LOX & LH<sub>2</sub> Chilldown Pump On ~ 2 hr 38 min

△ S-IVB Ullage On ~ 2 hr 42 min

△ O<sub>2</sub>/H<sub>2</sub> Burner Off ~ 2 hr 42 min

△ LOX & LH<sub>2</sub> Chilldown Pump Off ~ 2 hr 44 min

△ S-IVB Ullage Off ~ 2 hr 44 min

▲ S-IV Stage Engine Restart ~ 2 hr 44 min

NOTE:

Approximate times shown are measured from liftoff

\* If restart is delayed until the second injection opportunity this and major subsequent events will occur approximately one hour and twelve minutes later than shown.

\*\* Inhibited for first opportunity restart

△ \*\* S-IVB LOX & LH<sub>2</sub> Point Level Sensor Enable ~ 2 hr 49 min

▲ S-IVB Stage Engine 2nd Cutoff ~ 2 hr 50 min

△ \*\* S-IVB LOX & LH<sub>2</sub> Point Level Sensor Disarm ~ 2 hr 50 min

△ LH<sub>2</sub> Vent Valve Open ~ 2 hr 50 min

△ S/C Control Enable ~ 2 hr 50 min

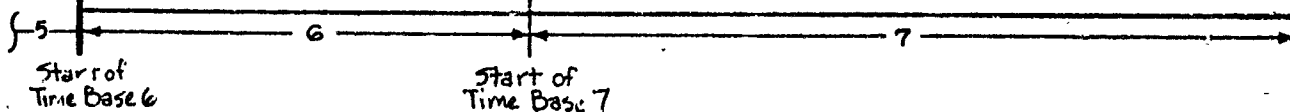

Start of Time Base 6

Start of Time Base 7

S-IVB Stage  
Flight Sequencing

Figure 12

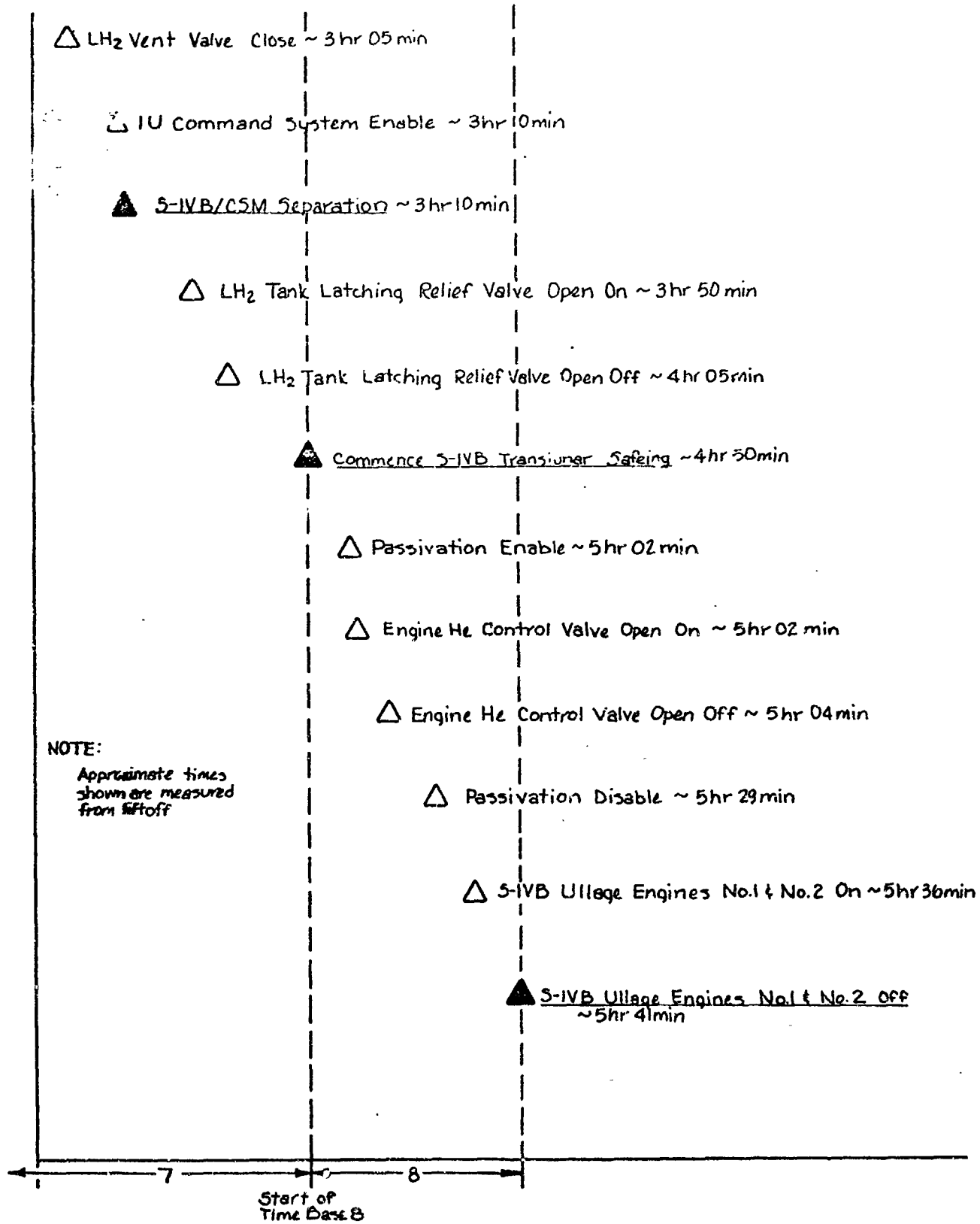

S-IVB Stage Flight Sequencing

Figure 13

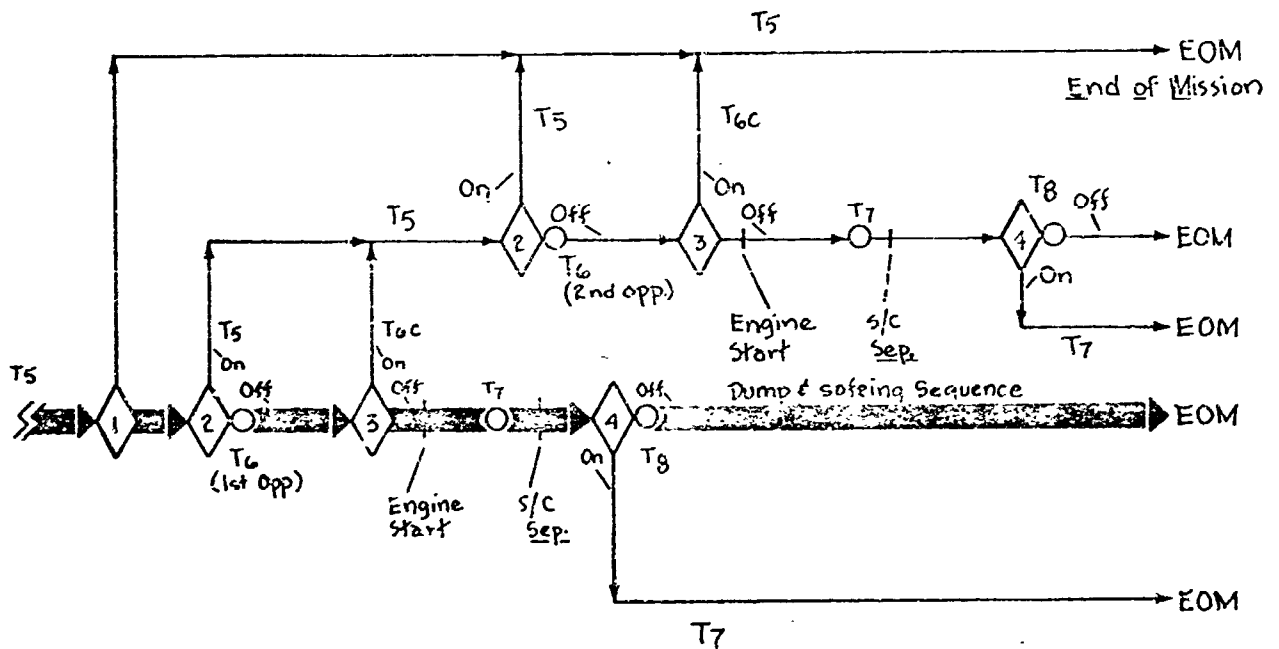

- 1 Time Base 6 Initiate Inhibit
- 2 Translunar Injection Inhibit (S/C switch) Prior to Time Base 6
- 3 Translunar Injection Inhibit (S/C switch) During Time Base 6
- 4 Inhibit Removed by Ground Command After Time Base 7 + 2 Hours

**Nominal Mission**

NOTE: in order to provide for ID/E in Earth Orbit, a Ground Command will inhibit the initiation of time Base 6 and Time Base 5 will continue to the EOM

Alternate  
Time Base Sequencing

figure 14

## GUIDANCE AND CONTROL SYSTEM (G&C)

### Function and Description

The G&C system provides the following basic functions during flight:

1. Stable positioning of the vehicle to the commanded position with a minimum amount of sloshing and bending.
2. A first stage tilt attitude program which gives a near zero lift trajectory through the atmosphere.
3. Steering commands during S-II and S-IVB burns which guide the vehicle to a predetermined set of end conditions while maintaining a minimum propellant trajectory for earth orbit insertion.
4. The proper vehicle position during earth orbit.
5. Guidance during the second S-IVB burn, placing the vehicle in the proper waiting orbit.

### G&C Hardware

The Stabilized Platform (ST-124M) is a three gimbal configuration with gas bearing gyros and accelerometers mounted on the stable element. Gimbal angles are measured by redundant resolvers and inertial velocity is obtained from integrating accelerometers.

The Launch Vehicle Data Adapter (LVDA) is an input-output device for the Launch Vehicle Digital Computer (LVDC). The LVDA/LVDC components are digital devices which operate in conjunction to carry out the flight program. The flight program performs the following functions: (1) processes the inputs from the ST-124M, (2) performs navigation calculations, (3) provides the first stage tilt program, (4) calculates IGM steering commands, (5) calculates attitude errors, (6) issues launch vehicle sequencing signals.

The Control/Eds Rate Gyro Package contains nine rate gyros (triple redundant in three axes). Their outputs go to the Control Signal Processor (CSP) where they are voted and sent to the Flight Control Computer (FCC) for damping vehicle angular motion.

The FCC is an analog device which receives attitude error signals from the LVDA/LVDC and vehicle angular rate signals from the CSP. These signals are filtered and scaled, then sent as commands to the S-IC, S-II, and S-IVB engine actuators and to the Auxiliary Propulsion System (APS) Control Relay Packages. The Control Relay Packages accept FCC commands and relay these commands to operate propellant valves in the APS. During spacecraft control of the launch vehicle, the FCC receives attitude error signals from the Command Module Computer or the Astronaut hand controller.

The Switch Selectors in each stage are used to control the inflight sequencing as commanded from the LVDA/LVDC.

S/C Backup. G&C/Manual Attitude Control Capability

(See Opposite Page for Description)

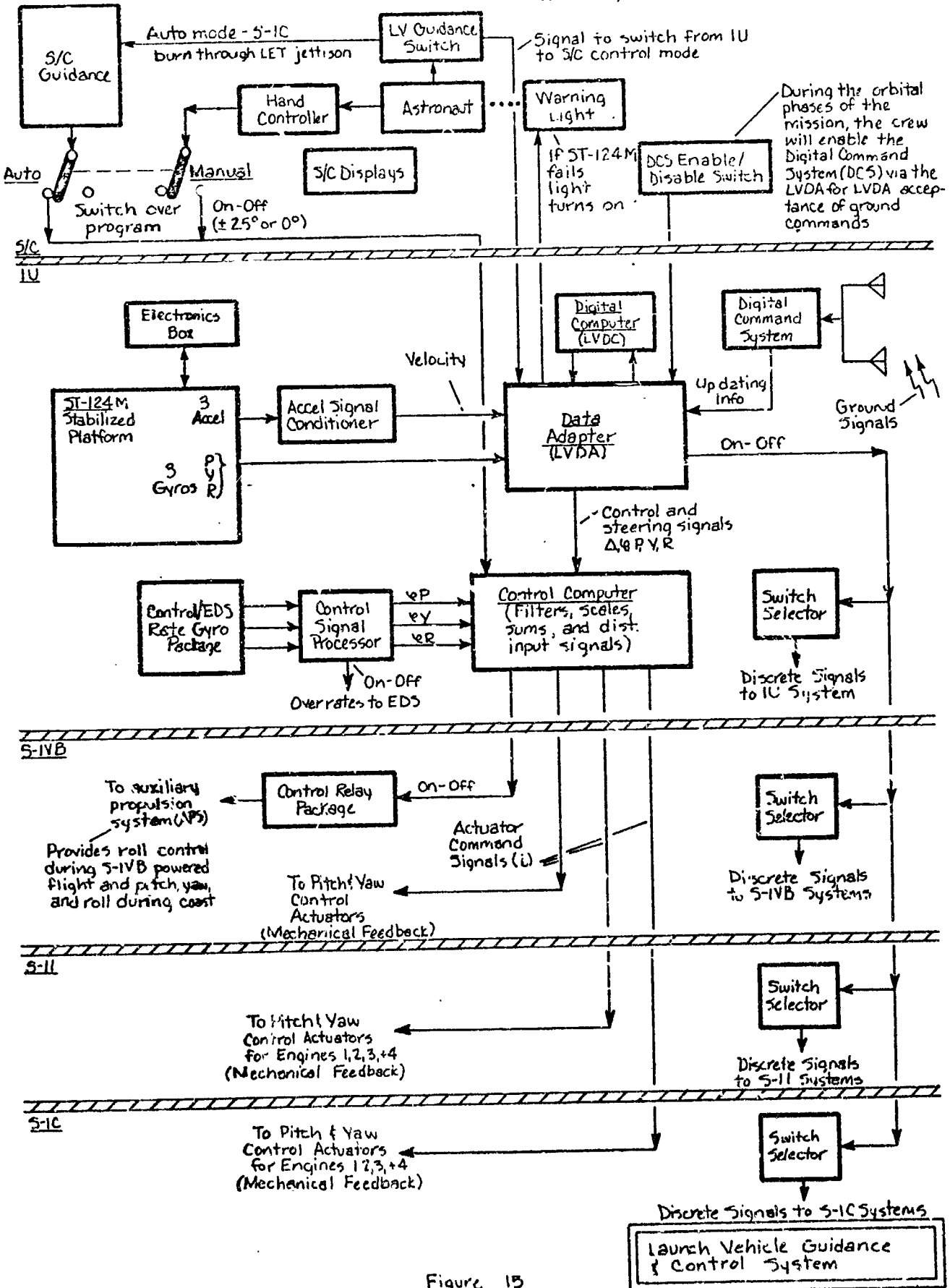

Figure 13

## SPACECRAFT BACKUP GUIDANCE AND CONTROL/MANUAL ATTITUDE CONTROL CAPABILITY

The Launch Vehicle Flight Control Computer will accept attitude commands from the spacecraft instead of the LVDC during (1) boost to Earth Parking Orbit (EPO); (2) orbital coast mode; (3) Translunar Injection (TLI) burn; and (4) the post TLI coast mode, with the following constraints:

### During Burn Modes

The Spacecraft attitude commands will be accepted by the flight control computer only in the event that the LVDA signals that the LV ST-124M Platform has failed followed by the Astronaut enabling the LV Guidance Switch. If the ST-124M Platform should fail before Time Base 6 (TB6) initiation, a navigation update by ground command will be required to start TB6 (S-IVB preps. and second burn). There are two modes to the backup system operations and they are:

#### (1) Automatic Backup Guidance and Control

In the automatic guidance mode both the control and guidance functions will be provided by the Spacecraft. This backup mode is used during S-IC stage flight and S-II flight up to LET jettison. The sequence of events are as follows:

- a. Failure of ST-124M is verified by LVDA.
- b. LVDA illuminates warning light in S/C.
- c. Astronaut enables LV Guidance switch.
- d. S/C transmits error signals to LV flight control computer.

#### (2) Manual Backup Guidance and Control

In the manual guidance mode both guidance and control loops will be closed through the Astronauts. An Astronaut continuously adjusts vehicle attitude via the Rotation Hand Controller to maintain the desired trajectory. Sequence of events following a Platform failure after LET jettison are:

- a. Failure of ST-124M verified by LVDA.
- b. LVDA illuminates warning light in S/C.
- c. Astronaut enables LV Guidance Switch.
- d. Manual guidance and control is initiated by the Astronaut entering a word into the S/C computer to switch AUTO/MANUAL switches to MANUAL.
- e. If automatic backup guidance is in operation at LET jettison, switching to manual backup is accomplished by performing step (d).

### During Orbital and Post TLI Coast Modes

In earth orbit and post TLI coast modes the Astronauts have a manual attitude control capability. The takeover follows somewhat the procedure for Manual Backup Guidance and Control takeover.

## EMERGENCY DETECTION SYSTEM

The Emergency Detection System (EDS) is designed to sense and react to emergency situations resulting from launch vehicle malfunctions which may arise during the mission. Crew safety and protection is the primary function of the EDS. Triple redundant sensors and majority voting logic are used in the automatic abort system. Dual redundancy is used for most of the manual abort sensors. The redundancy in the sensing systems is designed to protect against inadvertent aborts.

Automatic Aborts - During most of the S-IC flight, the EDS provides the capability of automatically aborting the mission. The automatic abort system is enabled at liftoff and disabled by the crew at approximately 2 minutes or by the IU switch selector prior to S-IC inboard engine cutoff. The system responds to failure modes that lead to rapid vehicle breakup. The parameters and the associated limits monitored for an automatic abort are:

1. Simultaneous loss of thrust on two or more S-IC engines
2. Vehicle rates in excess of  $\pm 4^\circ/\text{sec}$  in pitch or yaw; or  $\pm 20^\circ/\text{sec}$  in roll
3. S/C to IU breakup.

Manual Aborts - After the automatic abort mode is disabled, aborts may be initiated manually by the astronauts. Manual aborts are initiated based on at least two separate and distinct indications. The indications may be a combination of EDS sensor displays, physiological indications, and ground information to the astronauts. EDS displays for the crew consist of light and meters which indicate loss of thrust of each engine, staging sequences, launch vehicle attitude reference failure, angle of attack, tank ullage pressures, spacecraft attitude error and angular rates. The manual abort overrate limits are:

1. Pitch and Yaw - L.O. to S-IC/S-II Staging -  $\pm 10^\circ/\text{sec}$   
- S-IC/S-II Staging to S-IVB C.O. -  $\pm 9^\circ/\text{sec}$
2. Roll - L.O. to S-IVB C.O. -  $\pm 20^\circ/\text{sec}$

Aborts occurring during the launch phase will be performed by using either the Launch Escape System (LES) or the Service Propulsion System (SPS). The LES is used to propel the CM a safe distance from the launch vehicle and to ensure a water landing. Aborts prior to 30 seconds of flight do not terminate S-IC thrust in order to protect the launch area. The SPS aborts utilize the Service Module SPS engine to propel the CSM away from the launch vehicle, and to maneuver to a planned landing area or boost into a contingency orbit.

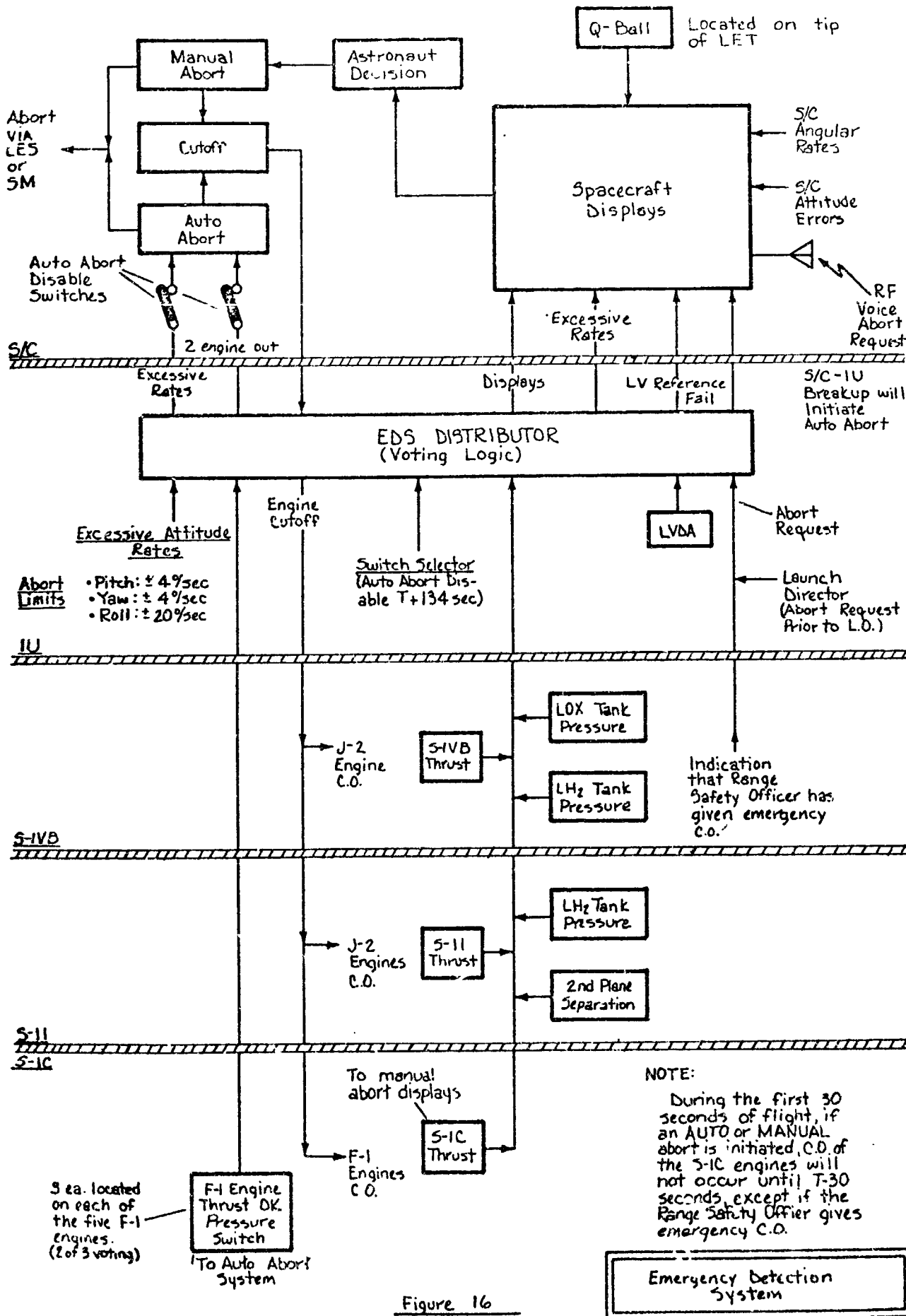

Figure 16



#### LAUNCH VEHICLE SECURE RANGE SAFETY SYSTEMS

The Secure Range Safety Systems, located on the S-IC, S-II and S-IVB stages, provide a means to terminate the flight of an erratic vehicle by the transmission of coded commands from ground stations to the vehicle during boost phase. The Range Safety Officer (RSO) terminates the flight of an erratic vehicle (trajectory deviations) by initiating the emergency engine cutoff command and, if necessary, the propellant dispersion command.

The command destruct system in each stage is completely separate and independent of those in the other stages with the exception of a 2 for 3 voting arrangement between the S-IC and S-II Range Safety System Controllers. This arrangement eliminates a single point failure in the S-IC range safety system controller, which, if it failed would cause an unnecessary S-IC engine cutoff.

The system in each powered stage consists of a range safety antenna subsystem, two secure command receivers, two Range Safety Controllers, two Secure Range Safety Decoders, two Exploding Bridge Wire (EBW) firing units, two EBW detonators and a common safe and arm device which connects the subsystem to the tank cutting charge. Electrical power for all elements appearing in duplicate is supplied from separate stage batteries.

Prior to launch, the safe and arm device is set to the "ARM" position by ground support equipment and the system remains active until orbital insertion. After orbital insertion, the S-IVB stage range safety receiver is deactivated (Safed) by ground command from the Range Safety Officer.

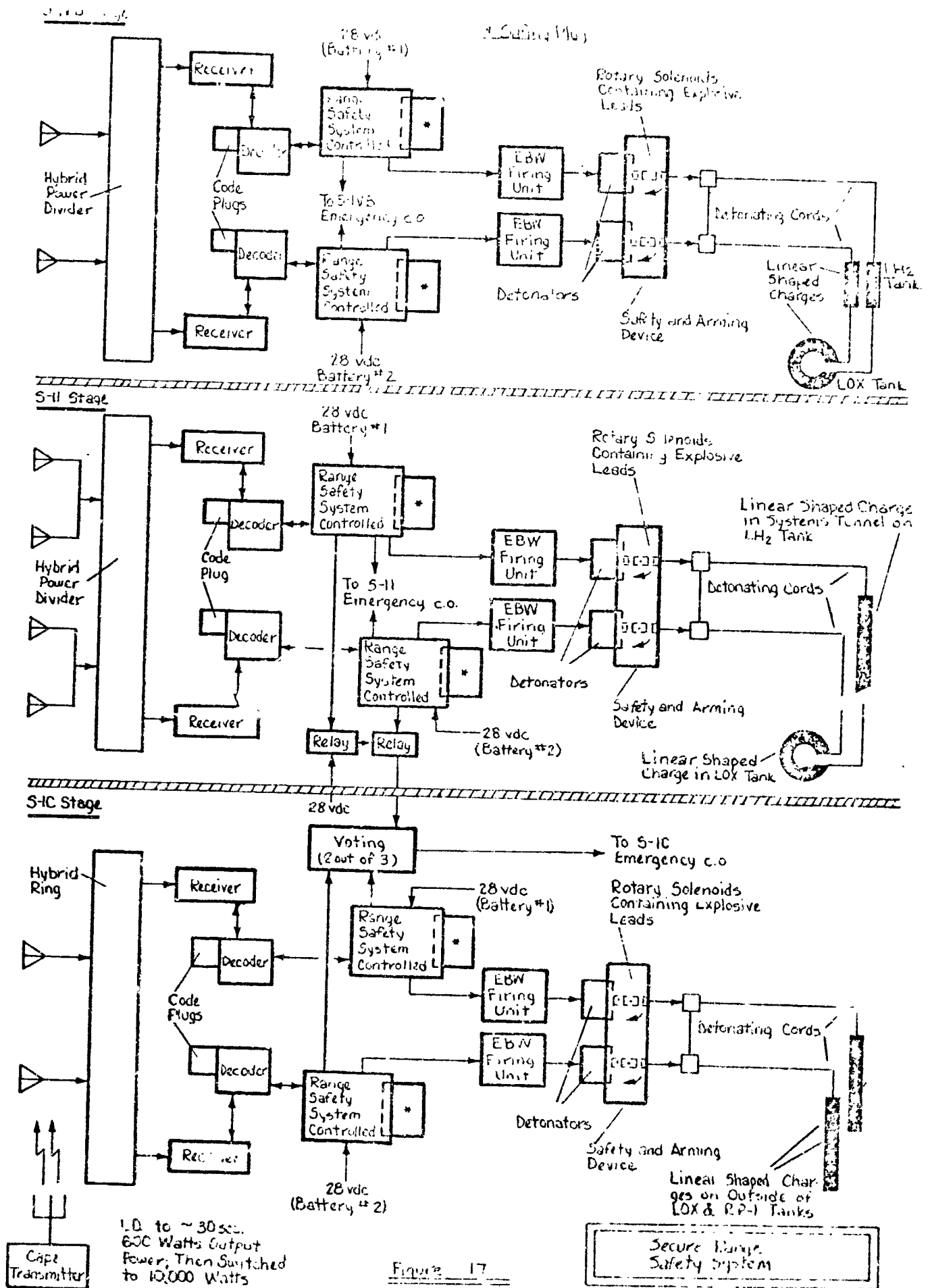

Figure 17

Secure Range Safety System

MEASUREMENT SYSTEM

The vehicle measurement systems senses performance parameters and feeds signals to the stage and spacecraft telemetry systems. It includes transducers, signal conditioning, and distribution equipment necessary to provide the required measurement ranges and suitably scaled voltage signals to the inputs of the telemetry systems. The vehicle measuring systems performs three main functions:

1. Detection of the physical phenomena to be measured and transformation of these phenomena into electrical signals.
2. Process and condition the measured signals into the proper form for telemetering.
3. Distribution of the data to the proper channel of the vehicle's telemetry systems.

The table on the opposite page contains a measurement breakdown for the launch vehicle and spacecraft, and a measurement summary of past Saturn V flights.

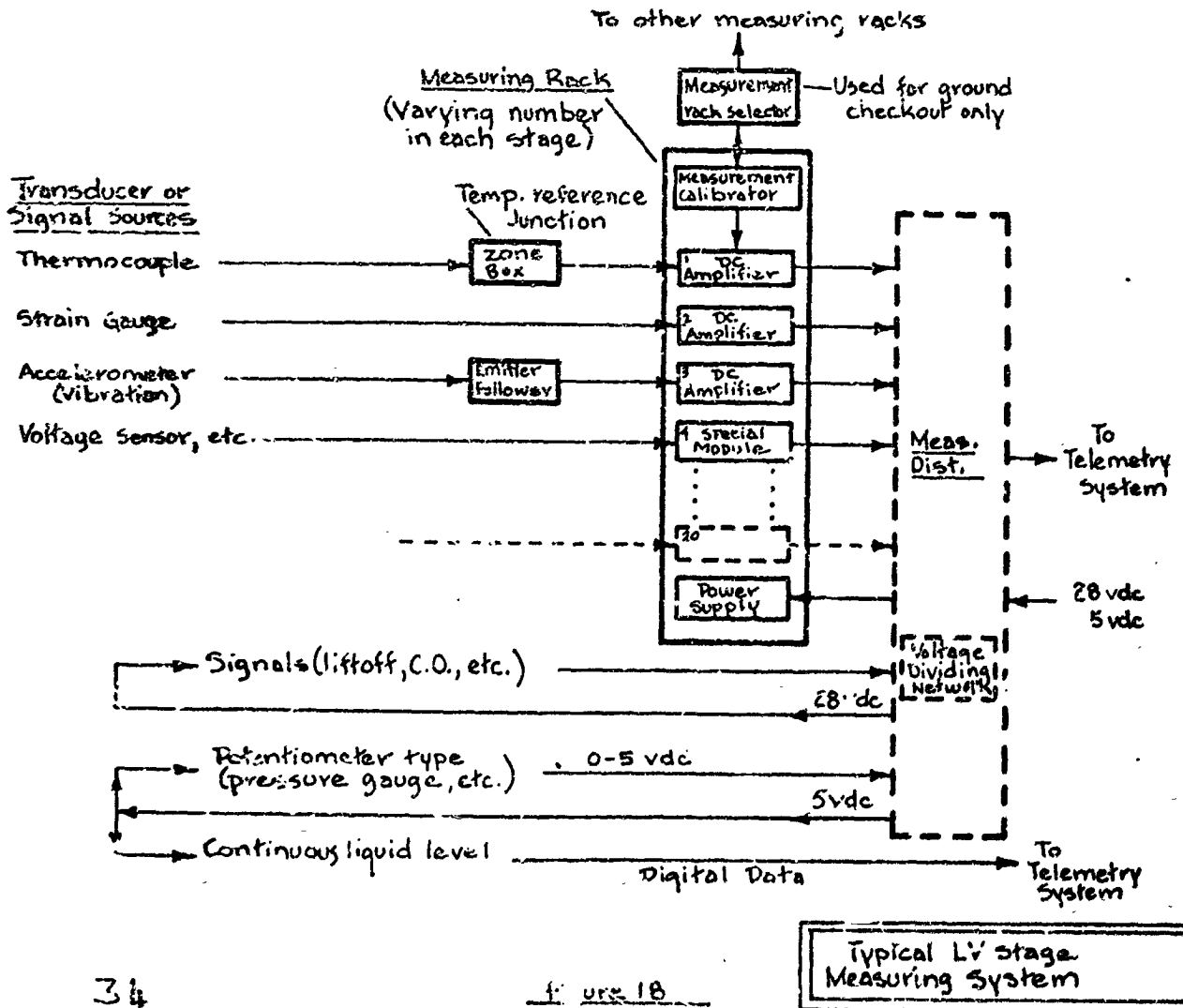

AS-506  
Launch Vehicle  
Measurement Summary

\*\* Included in Launch  
Vehicle Totals

Measurement Designation	S-IC	S-II	S-IVB	IU	L/V Totals
Accel. Flow Rate, & Liquid Level	17	12	11	8	48
Temperature	66	87	61	13	227
Pressure	89	105	79	10	283
Voltage, Current, & Frequency	6	33	38	17	94
Signals	127	221	71	65	484
Position, Angular Vel., Strain & RPM	25	54	10	42	131
Misc. RF & Telemetry	-	2	9	46	57
<b>TOTALS</b>	<b>330</b>	<b>514</b>	<b>279</b>	<b>201</b>	<b>1324</b>
ES3 Displays	65	185	98	175	523**
Auxiliary Display	37	57	69	15	178**
Flight Control	50	215	64	102	401**

AS-506  
Spacecraft Measurement Summary

Measurement Designation	CM	SM	LM	S/C Totals
Pressure	15	35	98	148
Temperature	18	43	160	221
Discrete Event	80	10	320	410
Voltage, Current & Frequency	45	7	190	242
Miscellaneous	35	50	120	205
<b>TOTALS</b>	<b>193</b>	<b>145</b>	<b>888</b>	<b>1226</b>

Previous Flights-Measurement Summary						
Vehicle	S-IC	S-II	S-IVB	IU	LV Totals	Spacecraft
AS-501	872	976	589	337	2774	-
AS-502	891	960	612	338	2801	-
AS-503	876	992	351	450	2669	338
AS-504	666	989	294	296	2245	1218*
AS-505	644	936	279	218	2077	1218*

\* LM measurements added to AS-504 & 505

Note: All measurement numbers approximate

Figure 19

Measurement Summary
---------------------

COMMAND AND COMMUNICATION INTERFACES FOR MISSION CONTROL

Mission Control Center (MCC) Manned Spacecraft Center, Houston, Texas. Contains communication, computers, display and command systems to monitor and control the space vehicle.

Kennedy Space Center, Florida (KSC). The space vehicle is assembled, checked-out, and launched from KSC. Central Instrumentation Facility (CIF) collects powered flight data and data received from Merritt Island Launch Area (MILA) and Air Force Eastern Test Range (AFETR).

Goddard Space Flight Center (GSFC). Greenbelt, Maryland operates the Manned Space Flight Network (MSFN) and NASA communications network. The MSFN is under control of MCC during flight.

George C. Marshall Space Flight Center (MSFC) Huntsville, Alabama. Using The Huntsville Operations Support Center (HOSC) and the Launch Information Exchange Facility (LIEF), real-time support is provided to KSC and MCC for preflight, launch and flight operations.

The Manned Space Flight Network is a global network of ground stations, ships, and aircraft designed to support manned and unmanned space flight.

While selected ground stations throughout the world monitor all phases of flight activity from liftoff to recovery, pre-destined ships and aircraft are strategically situated to monitor "Insertion to Earth Parking Orbit", "Translunar Injection", "Reentry and Recovery".

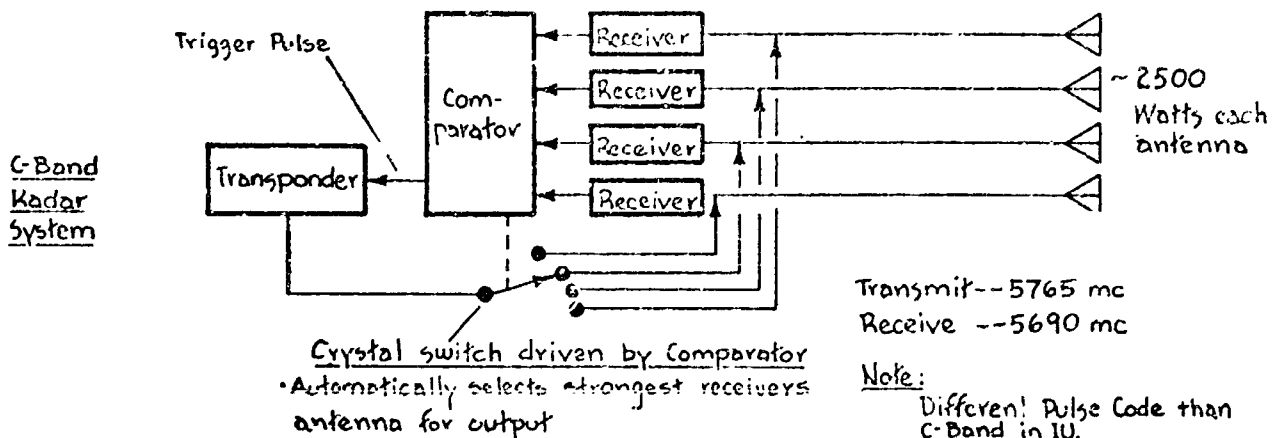

Unified S-Band System

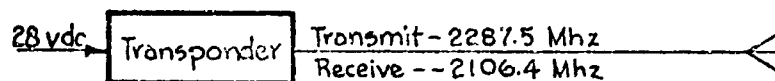

S/C

Unified S-Band System

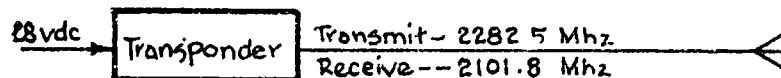

C-Band Radar System

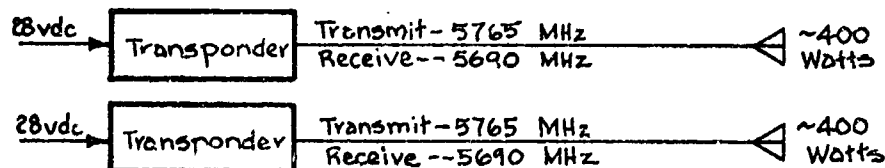

IU

### VEHICLE TRACKING SYSTEMS

In the Saturn V space vehicle there is a continuous requirement to transmit information to ground stations in order to determine the vehicle's trajectory. This requirement is satisfied by the RF tracking systems. The tracking data is used by mission control, range safety, and for post-flight evaluation of the vehicle's performance. The tracking systems used are:

#### C-Band (IU and S/C)

C-Band is a pulse radar system which is used for precise tracking during powered flight into earth orbit, orbital flight, injection into trans-lunar trajectory, and coast flight after injection.

#### S-Band (IU and S/C)

The Unified Side Band (USB) System provides tracking capability to the USB ground stations and these stations track the spacecraft to the moon.

Figure 20

Vehicle Tracking Systems

SPACE VEHICLE WEIGHT VS FLIGHT TIME

Mainstage propellant consumption during S-IC powered flight (approximately 161 seconds) is approximately 4,670,300 pounds. Propellant consumption during S-II powered flight (approximately 389 seconds) is approximately 971,450 pounds. During S-IVB powered flight, including first and second burns, (approximately 461 seconds) the propellant consumption is approximately 223,900 pounds.

<u>Vehicle Weight Data (Approximate)</u>	<u>Pounds</u>
Total at S-IC ignition	6,484,300
Total at liftoff	6,398,500
Total at S-IC OECO	1,826,900
Total at S-II ignition	1,453,800
Total at S-II OECO	469,700
Total at S-IVB 1st ignition	367,000
Total at S-IVB 1st ECO	297,500
Total at S-IVB engine restart	294,600
Total at S-IVB 2nd ECO	133,600
Total at S-IVB/CSM separation	120,900
Total at SC translunar injection	100,800

# REPRODUCIBILITY OF THE ORIGINAL PAGE IS POOR.

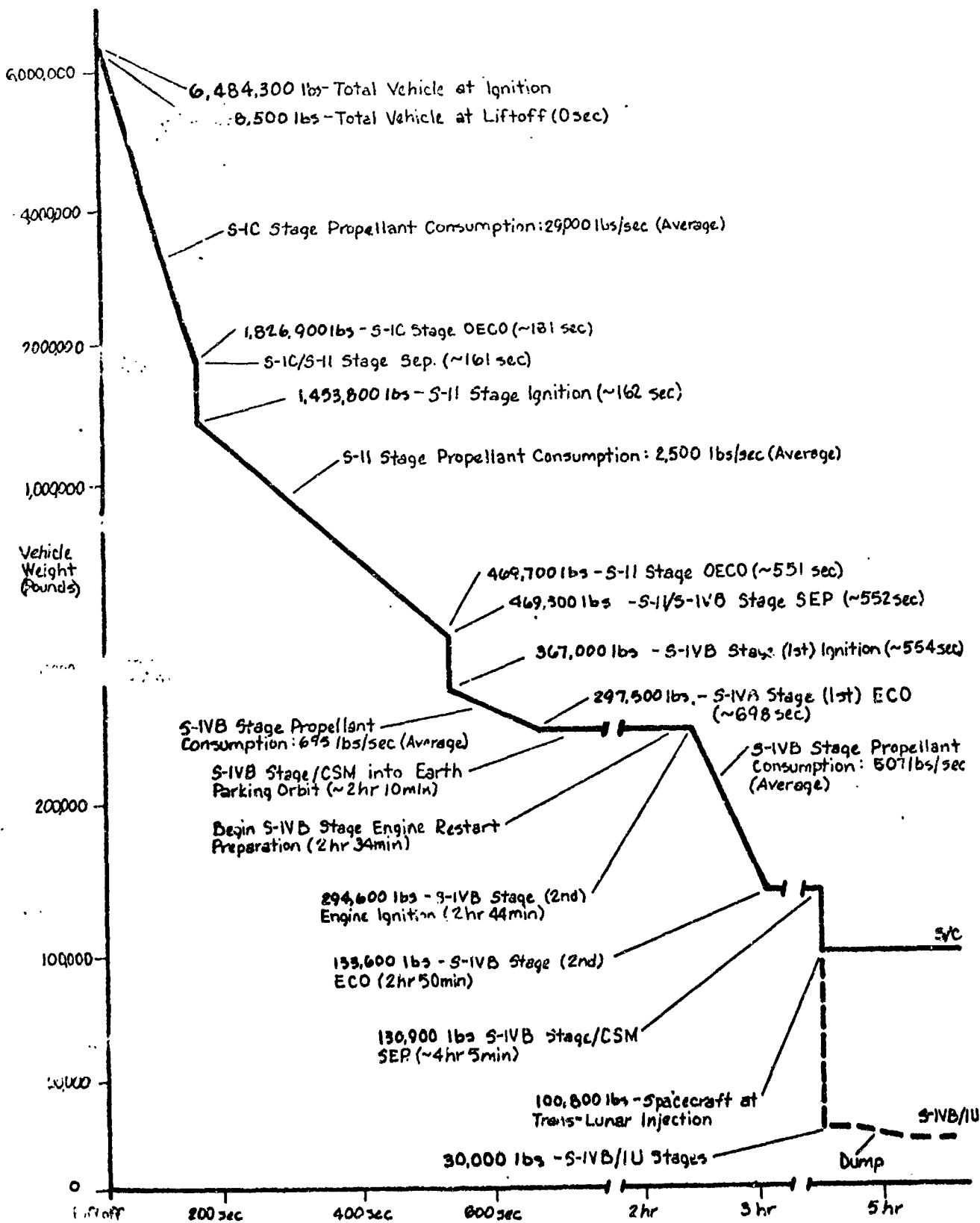

Above based on 2nd S-IVB burn occurring at first opportunity.

Figure 21

Space Vehicle Weight vs. Flight Time



## S-1C STAGE STRUCTURE

The S-1C stage is approximately 138 feet long and 33 feet in diameter and is powered by five liquid-fueled Rocketdyne F-1 engines which generate a nominal thrust of 7,610,000 pounds. Stage engines are supplied by a bi-propellant system of liquid oxygen (LOX) as the oxidizer and RP-1 as the fuel.

### The Forward Skirt

The Forward Skirt accommodates the forward umbilical plate, the electrical and electronic canisters, and the venting of the LOX tank and interstage cavity. The aluminum skin panels are stiffened by ring frames and stringers.

### The Oxidizer Tank

The 343,600 gallon capacity LOX tank is the structural link between the forward and intertank sections. Stiffened by machined "T" stiffeners the tank is internally equipped with ring baffles for additional stability as well as to reduce LOX sloshing and to provide support for four helium bottles.

### The Intertank Section

The intertank section provides structural continuity between the LOX and RP-1 tanks.

### The RP-1 (Fuel) Tank

The RP-1 fuel tank, located between the thrust structure and the intertank section, is a cylindrical aluminum structure with a capacity of 218,900 gallons. Antislosh ring baffles are located on the inner walls while cruciform baffles are located on the lower bulkhead. A lightweight foam material, bonded to the lower bulkhead, serves as an exclusive rise to minimize unusable residual fuel.

### The Thrust Structure

The thrust structure provides support for the five engines, the base heat shield, engine fairings and fins, propellant lines, retro rockets and environmental control ducts. The lower thrust ring also has four-holddown points to restrain the vehicle, as necessary, from lifting off at full F-1 engine thrust.

### Pogo Suppression

The longitudinal oscillation in the LV, or "Pogo" effect as it has been called, has been suppressed by utilizing the LOX pre-vent cavities in the four outboard engines as surge chambers. Each of the four cavities is pressurized with gaseous helium (GHe) at T -11 minutes from ground supply. Initial fill is closely monitored using liquid level resistance thermometers. Ground fill maintains cavity pressure until umbilical disconnect after which pressure is maintained by the cold helium spheres in the LOX tank. Pressure readings are transmitted via telemetry to ground monitors during flight.

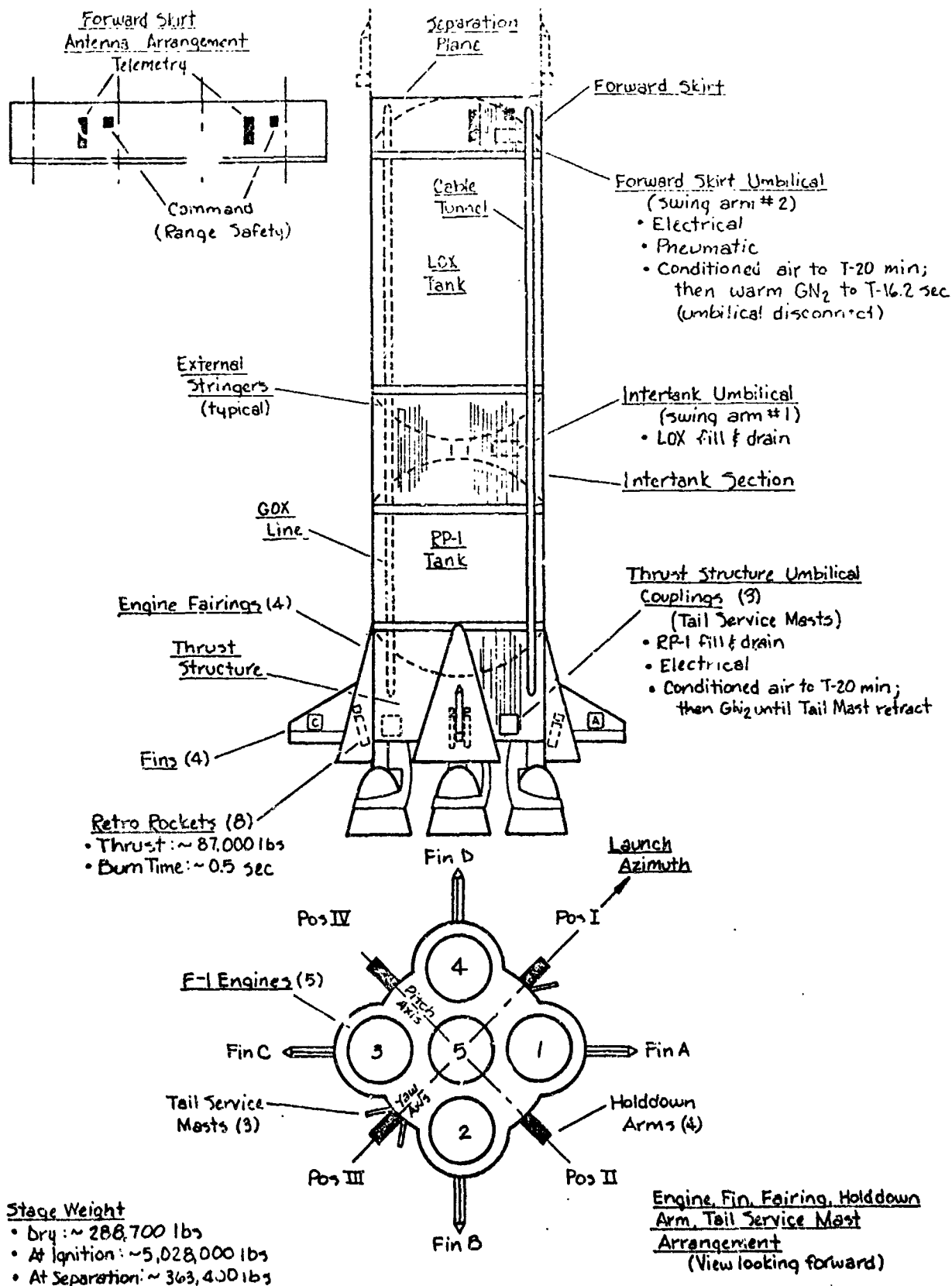

Figure 22

3-IC Stage Configuration

### F-1 Engine Operation

The F-1 engine is started by ground support equipment. Ground fluid pressure is applied to ports in the main LOX valves. Opening of the main LOX valves admits LOX to the tank pressure to the thrust chamber and allows control fluid to enter the gas generator. Opening of the gas generator valve permits LOX and RP-1 to enter the gas generator combustion chamber where they are ignited by the turbine exhaust igniters. While the RP-1 reaches approximately 375 psig a valve in the hypergol cartridge opens allowing LOX and RP-1 to build up pressure against the hypergol burst diaphragm. At approximately 500 psig the diaphragm ruptures allowing hypergol and RP-1 to enter the thrust chamber causing spontaneous combustion upon contact with the LOX, thereby establishing primary ignition. As thrust pressure builds up the RP-1 valves open admitting RP-1 to the thrust chamber and the transition to mainstage operation is achieved.

The inboard engine engine is cutoff by a signal from the IU. Outboard engines are cutoff by optical type LOX depletion sensors with fuel depletion sensors as back-up. A command from the IU supplies a command to the switch selector to enable the outboard engine cutoff circuitry. When two or more of the four LOX level sensors are energized, a timer is activated. Expiration of the timer energizes a stop solenoid for each engine which energizes the main LOX and main RP-1 valves. The sequence closing of the main LOX valve followed by sequence closing of the main RP-1 valve interrupts propellant flow and terminates engine operation.

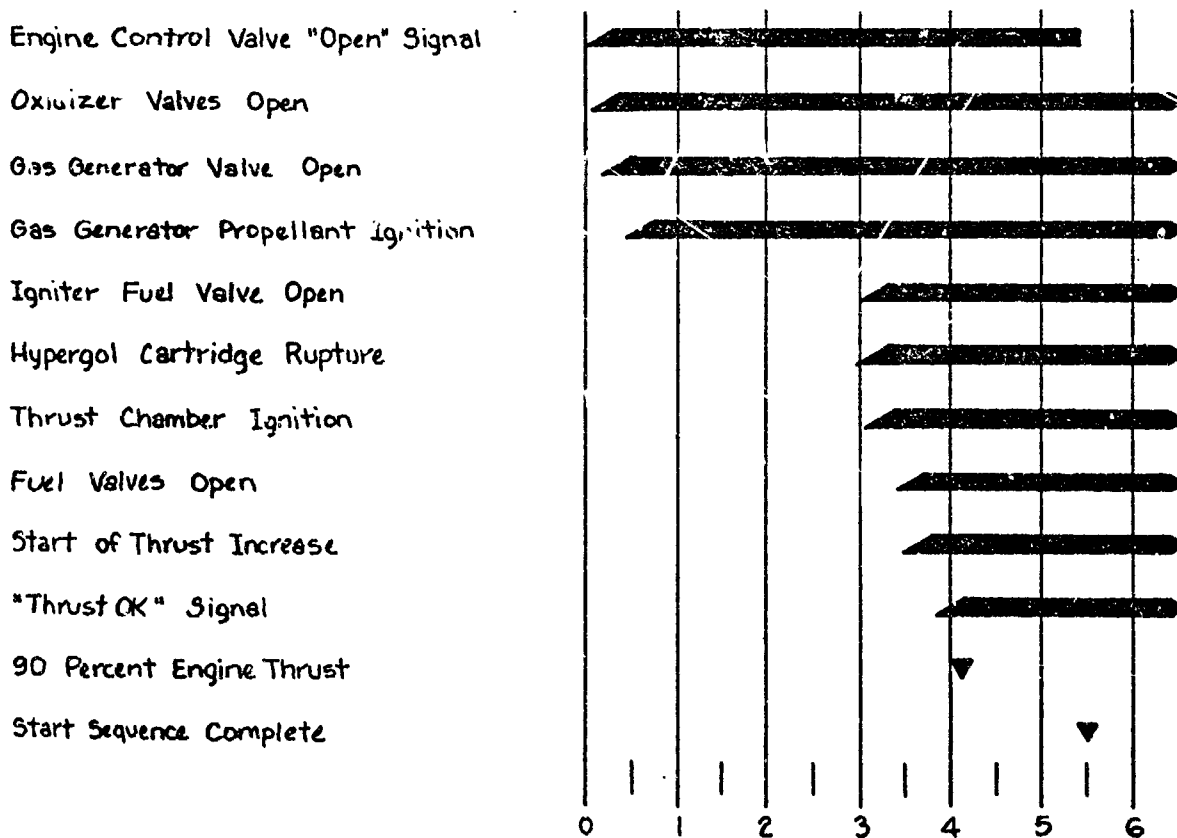

Engine Start Sequence in Seconds from Control Valve "Open" Signal

The turbopump is a combined LOX and fuel pump driven through a common shaft by a single gas turbine

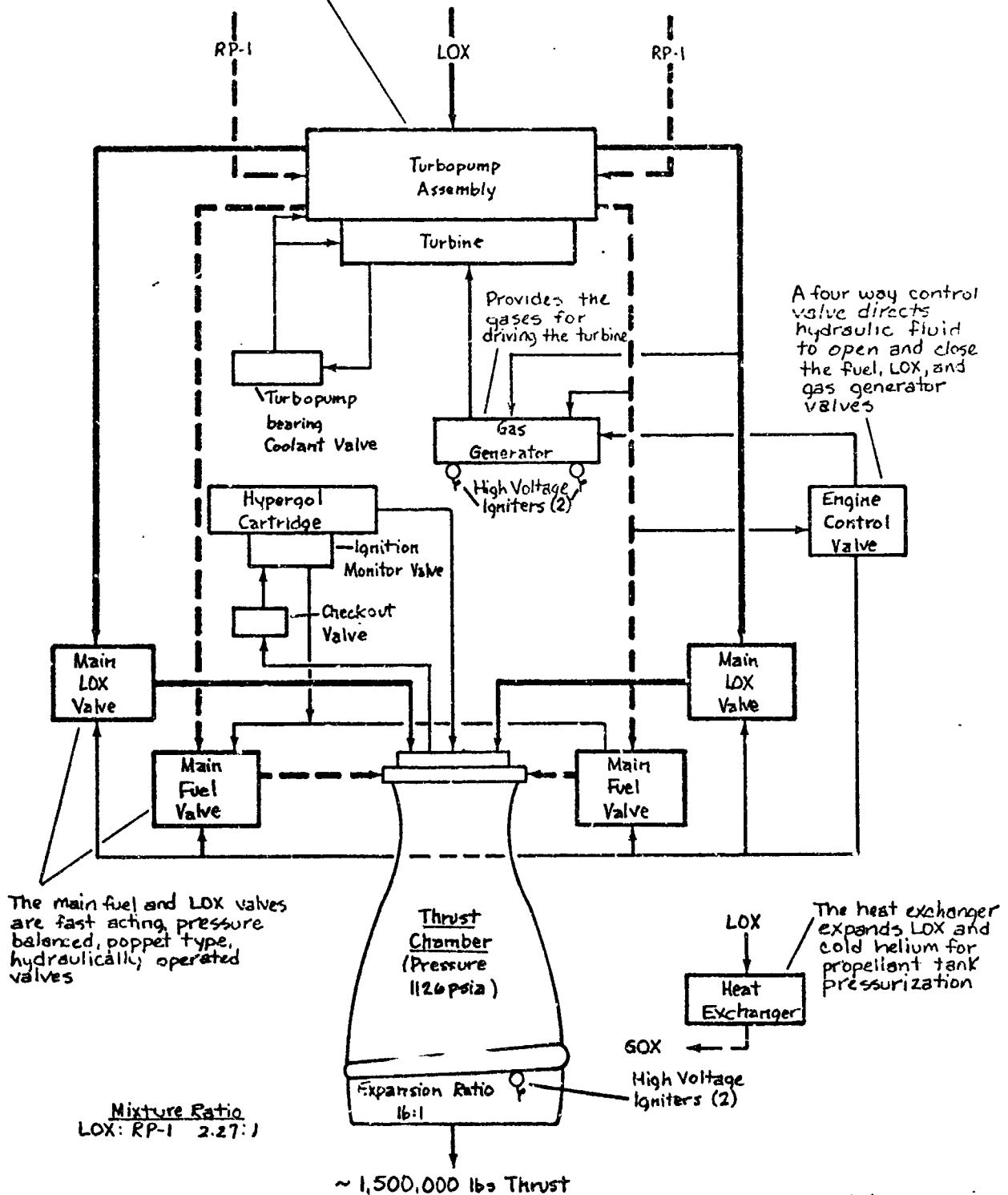

Figure 23

F-1 Engine System

S-IC STAGE PROPELLANT SYSTEM

The S-IC stage propellant system is composed of one LOX tank, one RP-1 tank, propellant lines, control valves, vents, and pressurization subsystems. Loading of LOX and RP-1 tanks is controlled by ground computers. RP-1 loading is completed approximately nine days prior to liftoff. LOX bubbling is started at the beginning of LOX chardown operation and is continued throughout LOX loading and again before liftoff to prevent possible geysering. Prior to liftoff the RP-1 tank and the LOX tank is pressurized by helium from a good source. At liftoff the RP-1 tank is pressurized with helium stored in bottles located in the LOX tank and heated by passing the helium through the heat exchanger. LOX tank pressurization is maintained by LOX bled from the engine and converted to GOX in the heat exchanger.

S-IC PROPELLANT LOAD AND OPERATIONAL SEQUENCE

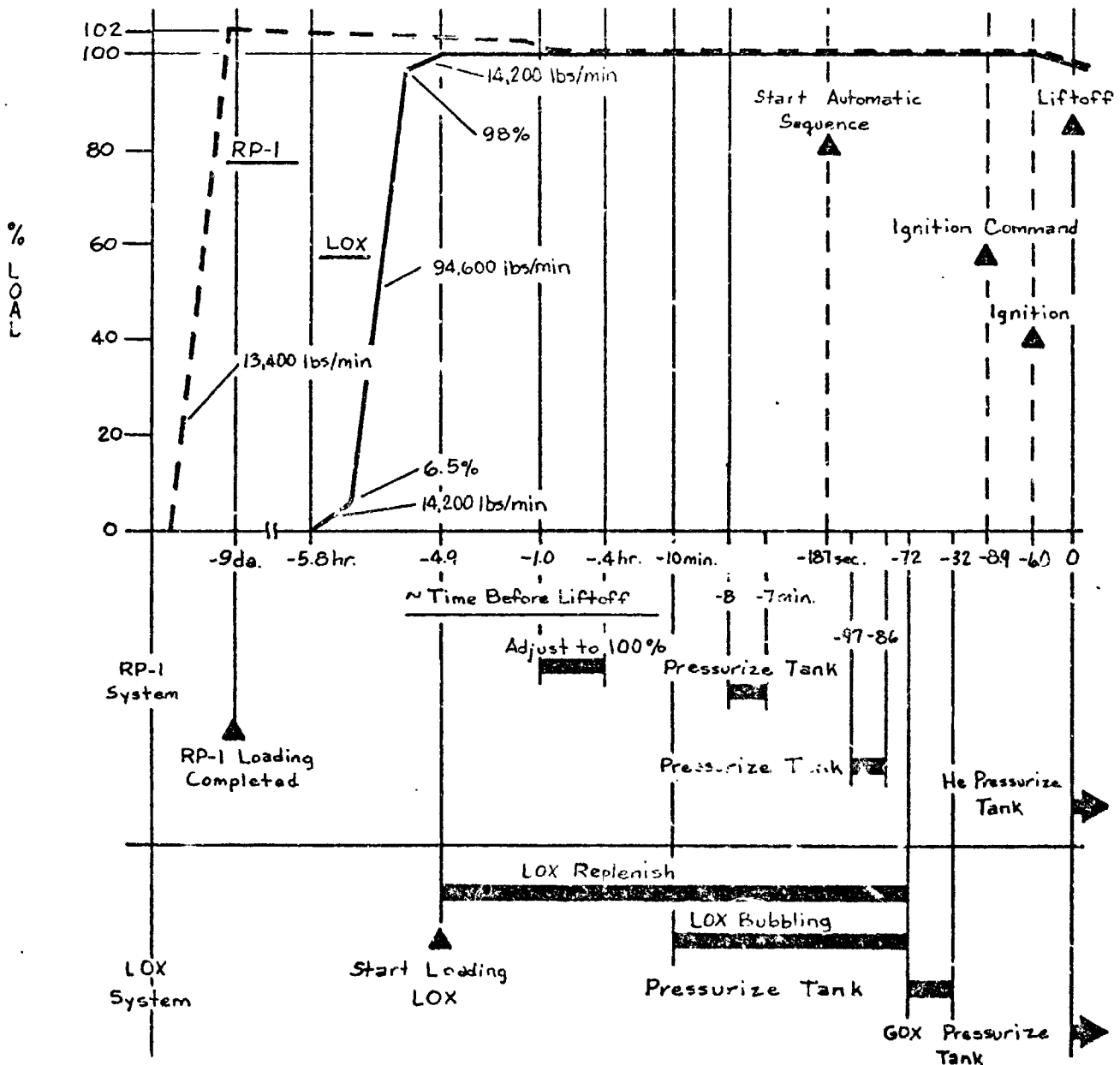

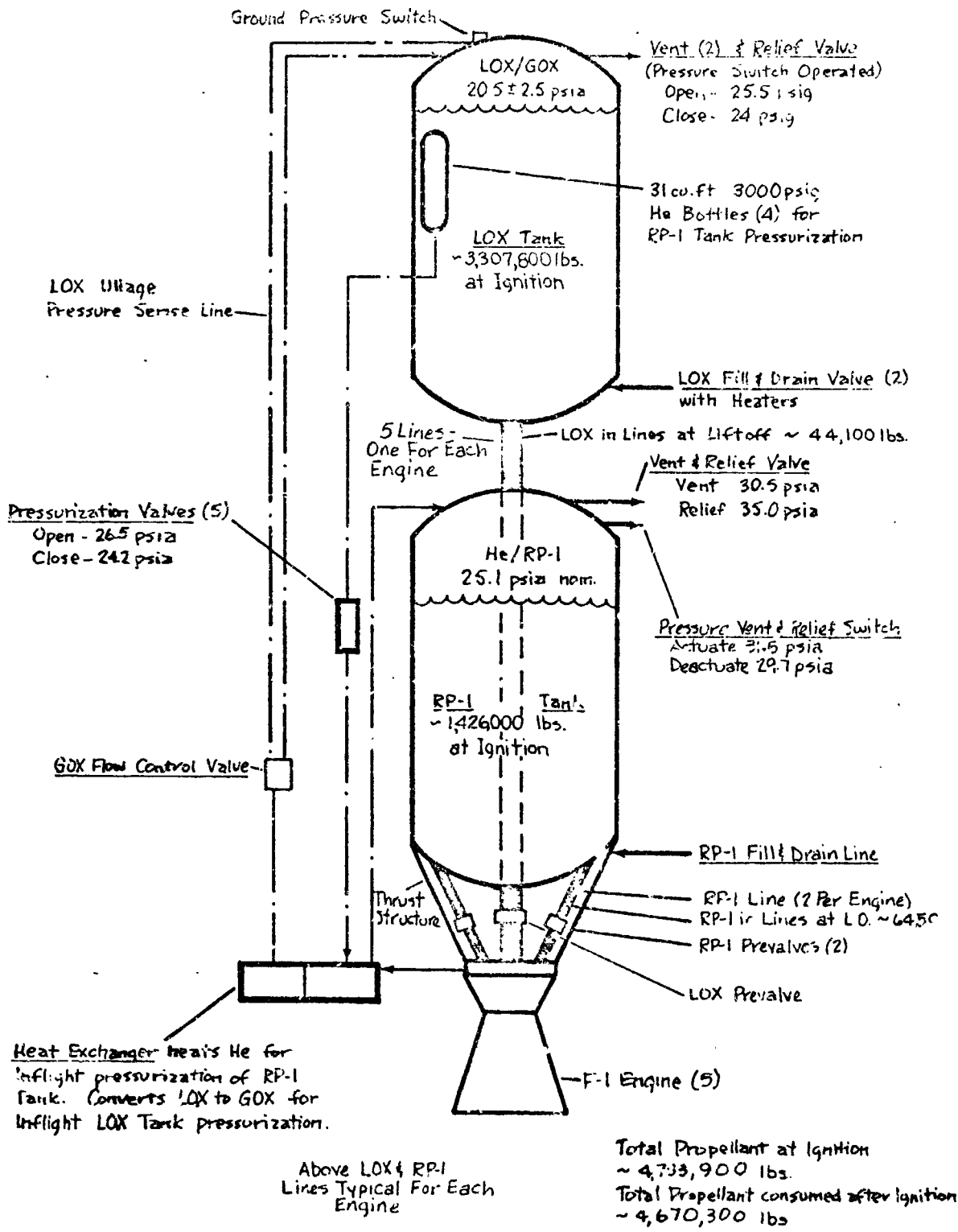

J-1C Propellant System

Figure 24

### S-IC STAGE THRUST VECTOR CONTROL SYSTEM

The four outboard F-1 engines are gimbal mounted on the stage thrust structure to provide attitude control during S-IC stage powered flight. Each independent gimbal system employs two hydraulic servo actuators. These servo actuators convert electrical command signals (from IU Flight Control Computer) and hydraulic pressure into mechanical outputs which gimbal the outboard engines on the S-IC stage. An integral mechanical feedback, varied by piston position, modifies the effect of the control signal from the FCC. Built-in servo actuator potentiometers sense servo actuator positions for telemetry as well as providing an interlock to preclude liftoff with an engine hardover.

Hydraulic pressure is supplied to the Thrust Vector Control System from a GSE pressure source during prelaunch checkout and engine start. The GSE pressure source utilizes RJ-1 ramjet fuel as the hydraulic fluid. During engine operation, hydraulic pressure is supplied from the fuel discharge of the engine turbo pump to the servo actuators. The fuel returns through a check valve to the fuel inlet of the turbo pump. RP-1, the fuel used by the S-IC stage, is used as the hydraulic fluid during engine operation.

# REPRODUCIBILITY OF THE ORIGINAL PAGE IS POOR

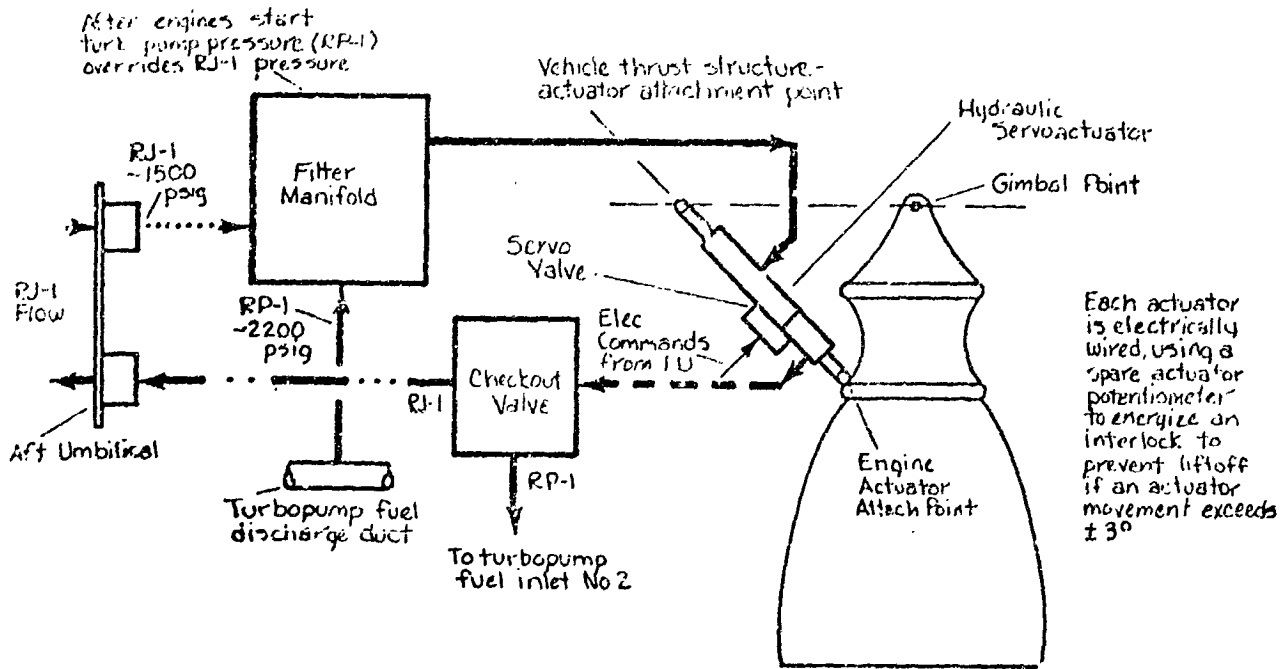

**NOTE:**  
Check valves in the Filter Manifold block the flow of fluid from the Filter Manifold to the engine when operating on ground supply and to the ground supply inlet when on flight supply

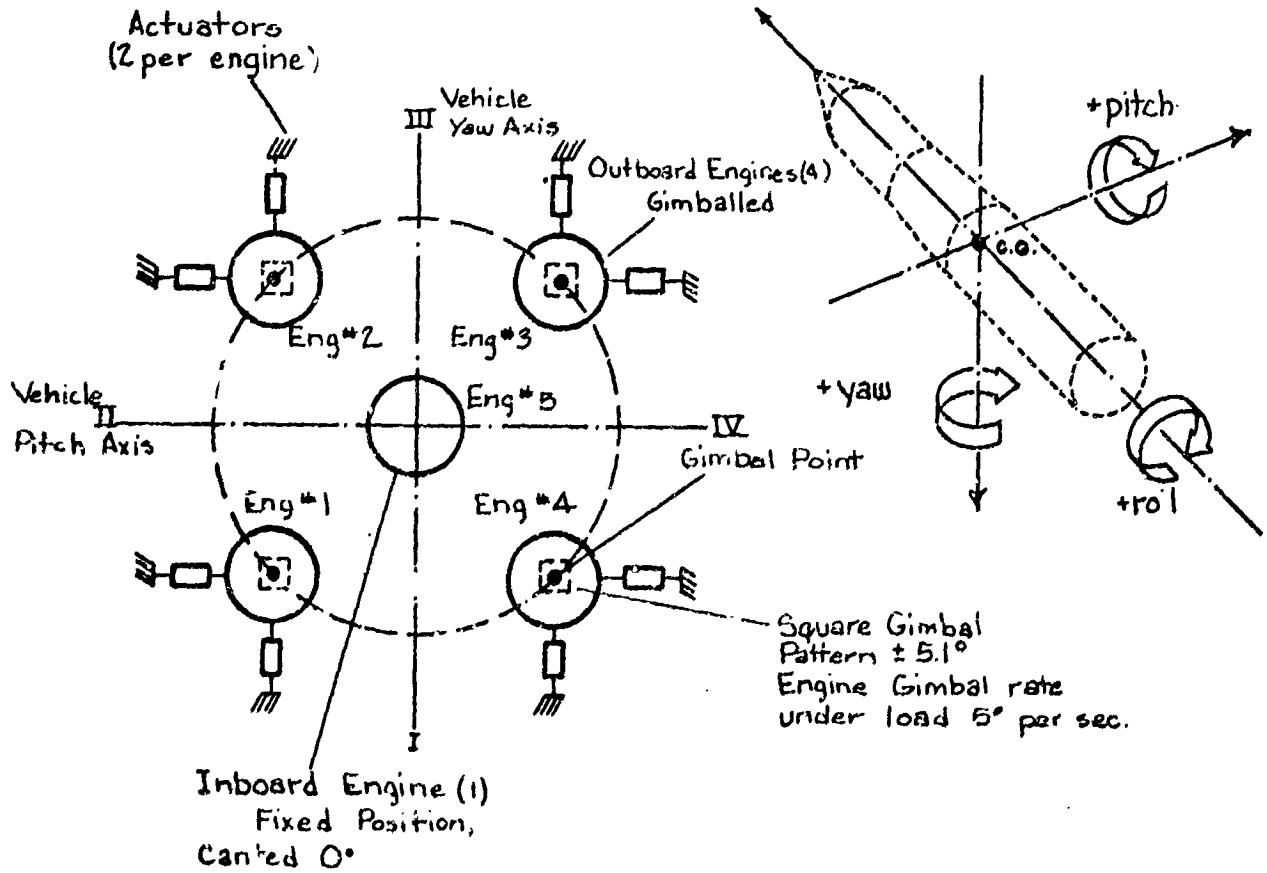

Figure 25

S-IC Thrust Vector Control System



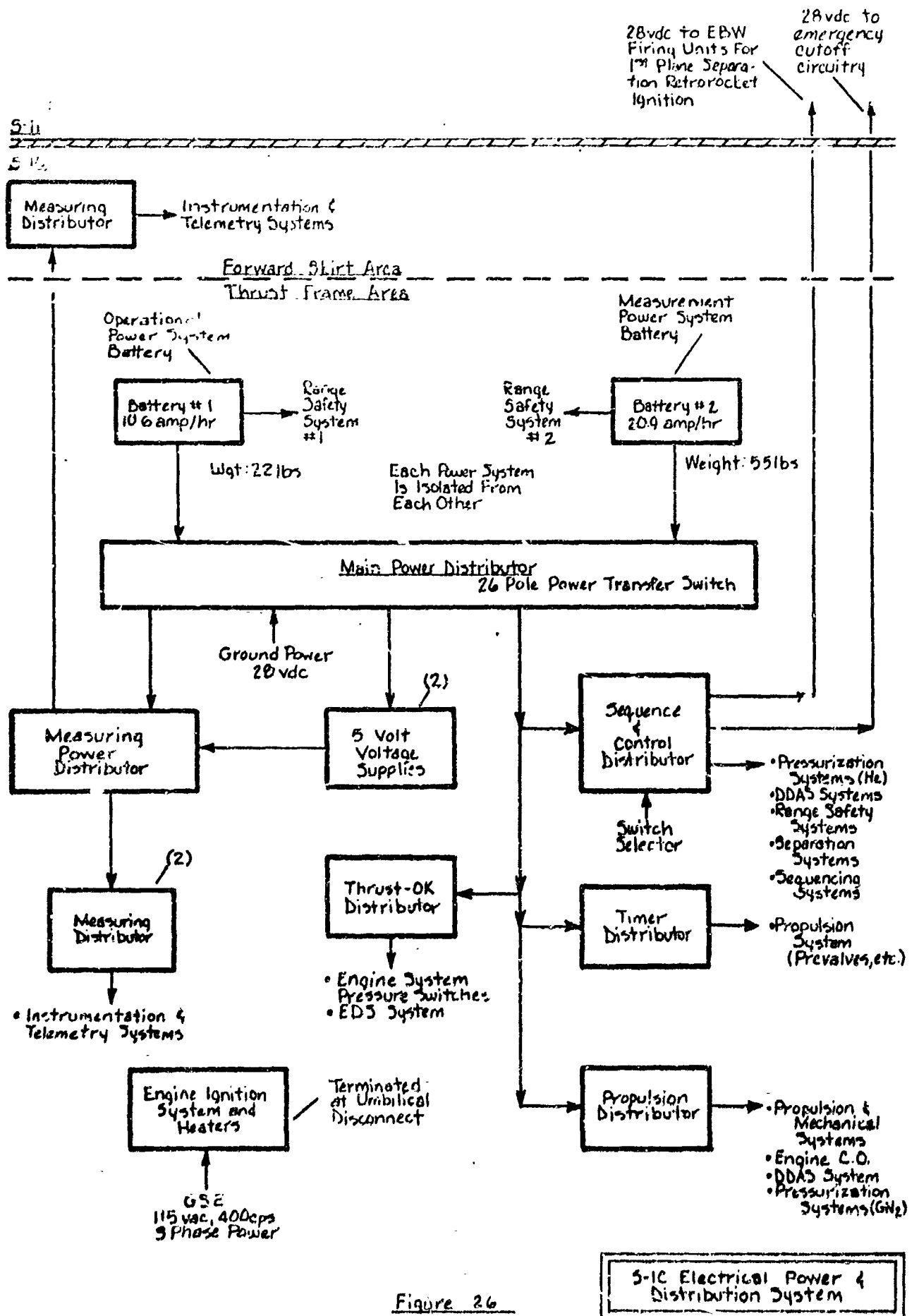
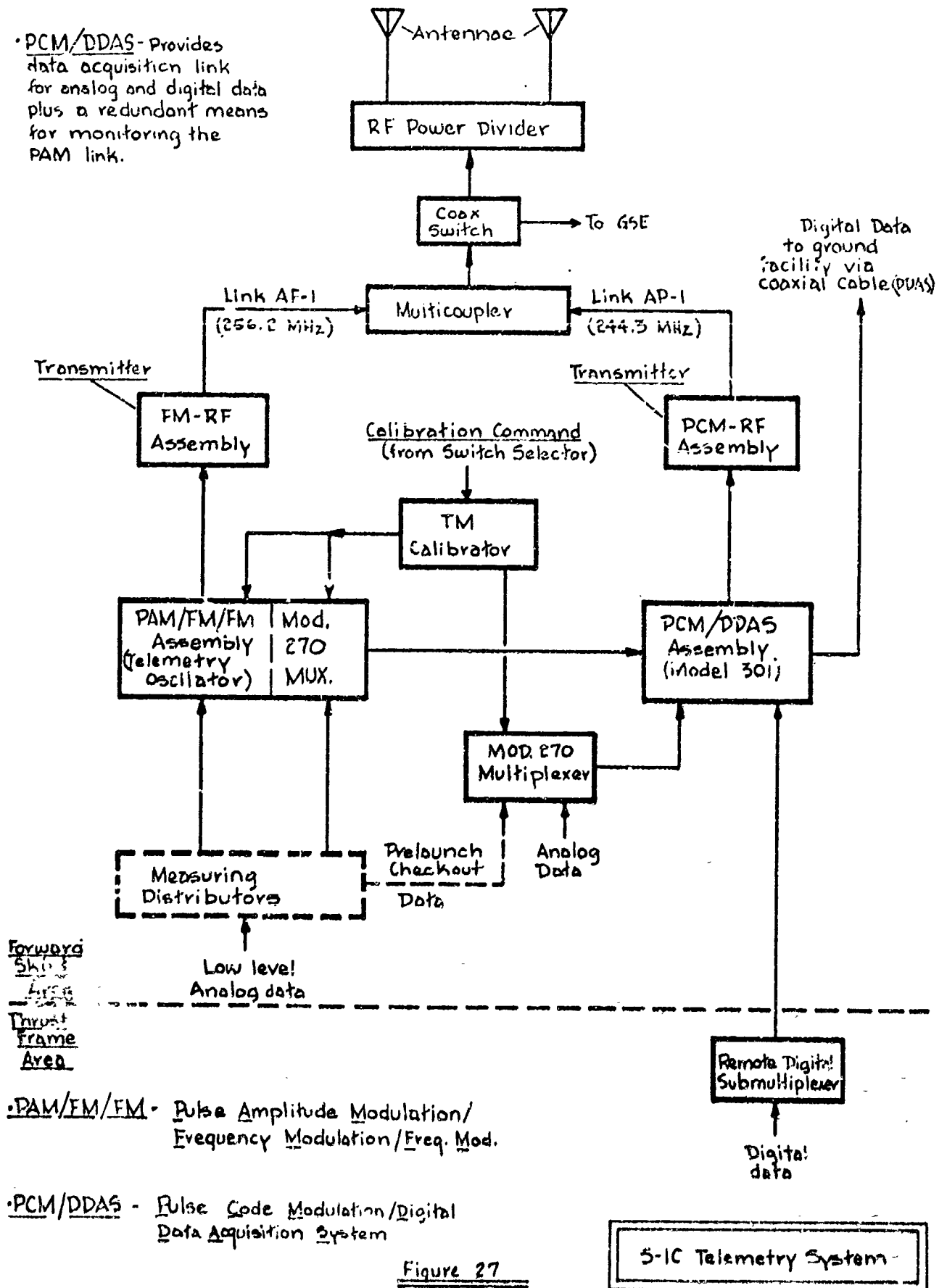

Figure 26

S-1C Electrical Power & Distribution System

• PCM/DDAS - Provides data acquisition link for analog and digital data plus a redundant means for monitoring the PAM link.



• PAM/FM/FM - Pulse Amplitude Modulation/  
Frequency Modulation/Freq. Mod.

• PCM/DDAS - Pulse Code Modulation/Digital  
Data Acquisition System

Figure 27

## S-II STAGE STRUCTURE

The S-II stage is a large cylindrical booster approximately 81 feet in length and 33 feet in diameter. The stage is powered by five liquid-propelled J-2 rocket engines which combine to develop a total thrust of 1,150,000 pounds.

### Forward Skirt

The forward skirt, a part of the S-II body shell structure, is a cylindrical aluminum alloy material, strengthened and supported internally and externally by stringers and circumferential ring frames. The forward skirt also houses the telemetry and command (range safety) antennae.

### The Fuel (LH<sub>2</sub>) Tank

The LH<sub>2</sub> tank is a long cylinder with a concave bulkhead forward and a convex bulkhead aft. The tank structure is made up of six cylindrical sections which incorporate stiffening members in both the longitudinal and circumferential directions.

### The Common Bulkhead

This is an adhesive-bonded assembly of aluminum alloy and fiberglass/phenolic honeycomb core to prevent heat transfer and retain the cryogenic properties of the fluids to which it is exposed (LOX and LH<sub>2</sub>). Fiberglass core material varies in thickness between .080 inches to 5 inches. No connections or lines pass through the common bulkhead.

### The LOX Tank

The LOX tank consists of ellipsoidal fore and aft halves with reinforced gore segments. Three ring type slosh baffles control propellant sloshing and minimize surface disturbances. A six part sump assembly at the lowest point provides fill and drain openings for the five engine feed lines.

### Aft Interstage

The aft interstage, also part of the body shell structure, is made up of aluminum alloy material and is supported internally by hat stringers and circumferential ring frames. The aft interstage has four ullage rockets mounted in its outer surface.

### System Tunnel

The systems tunnel houses electrical cables, pressurization lines and the propellant dispersion ordnance. The tunnel is attached externally from the S-II stage aft skirt to the forward skirt.

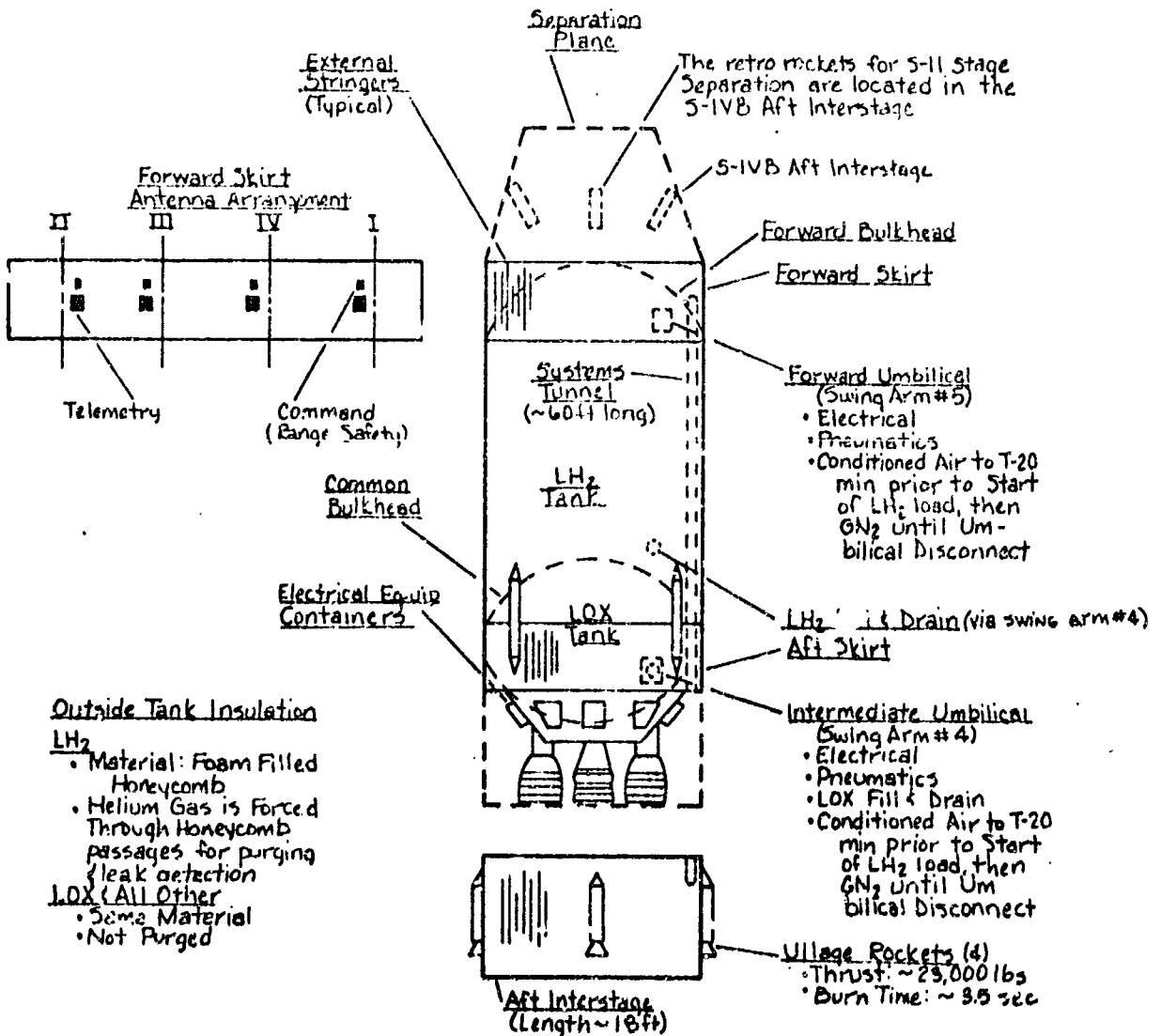

Outside Tank Insulation

- LH<sub>2</sub>
- Material: Foam Filled Honeycomb
  - Helium Gas is Forced Through Honeycomb passages for purging & leak detection
- LOX (All Other)
- Same Material
  - Not Purged

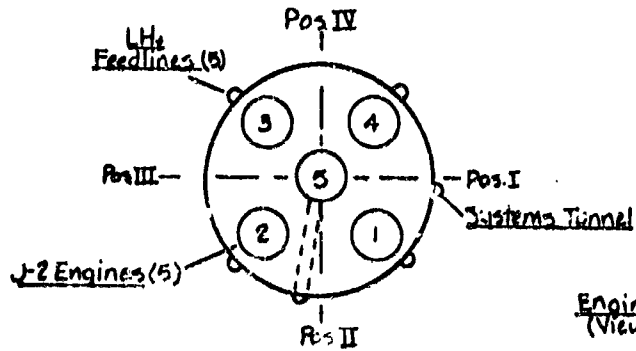

Engine Arrangement (View Looking Forward)

S-II Stage Weights

- Dry: ~79,900 lbs.
- At S-II Ignition: 1,059,900 lbs
- At S-II Cutoff: ~94,500 lbs
- At S-II Separation: ~94,100 lbs

S-II Configuration

Figure 2B

J-2 ENGINE OPERATION S-II STAGE

The operating cycle of the J-2 Engine consists of prestart, start, steady-state operation and cutoff sequences. During prestart, LOX and LH<sub>2</sub> flow through the engine to temperature-condition the engine components, and to assure the presence of propellant in the turbopumps for starting. Following a timed cool-down period, the start signal is received by the sequence controller which energizes various control solenoid valves to open the propellant valves in the proper sequence. The sequence controller also energizes spark plugs in the gas generator and thrust chamber to ignite the propellant. In addition, the sequence controller releases GH<sub>2</sub> from the start tank. The GH<sub>2</sub> provides the initial drive for the turbopumps that deliver propellant to the gas generator and the engine. The propellant ignites, gas generator output accelerates the turbopumps, and engine thrust increases to main stage operation. At this time, the spark plugs are de-energized and the engine is in steady-state operation.

Steady-state operation is maintained until a cutoff signal is received by the sequence controller. The sequence controller de-energizes the solenoid valves which in turn close the engine propellant valves in the proper sequence. As a result, engine thrust decays and the cutoff sequence is complete.

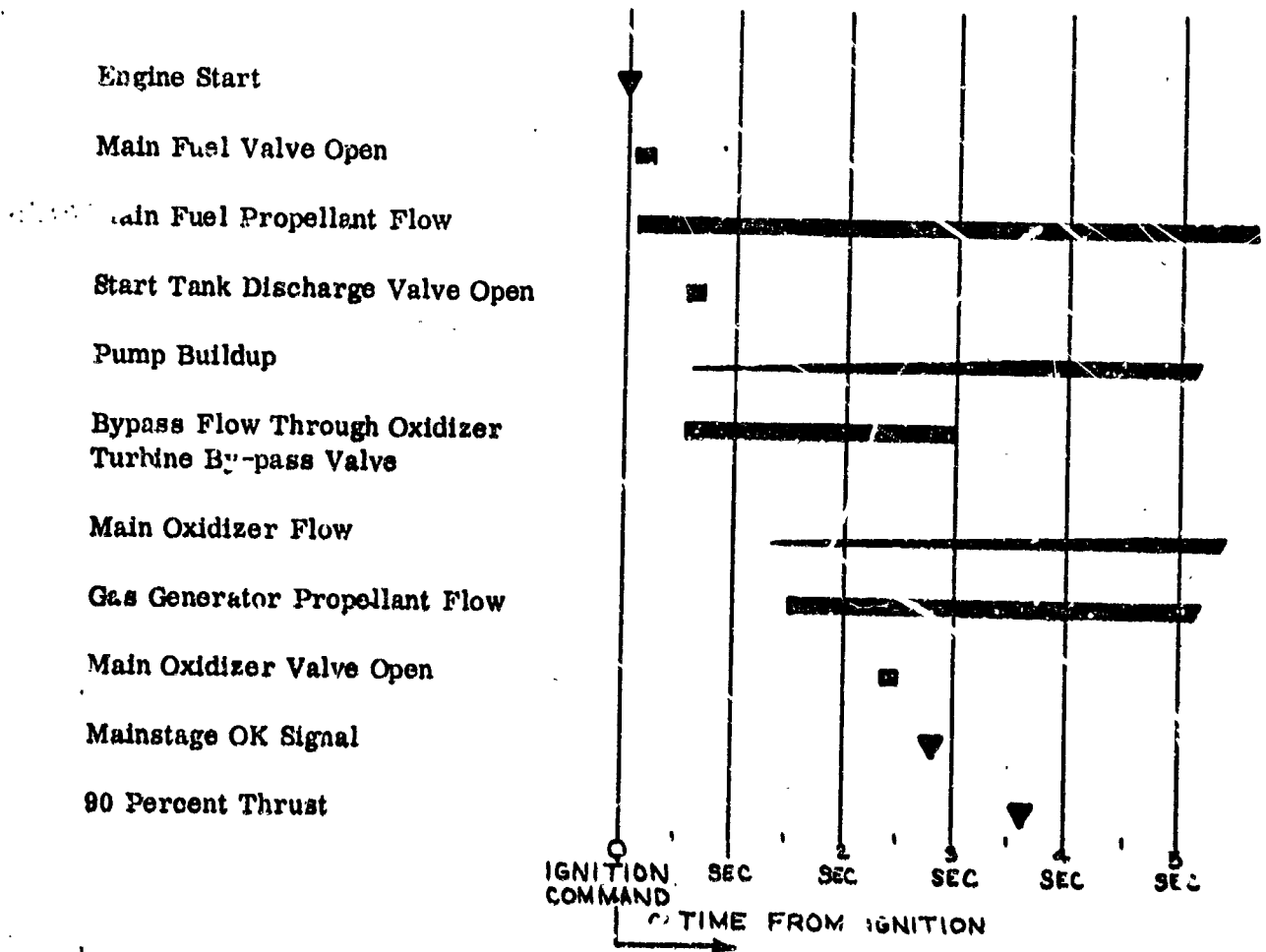

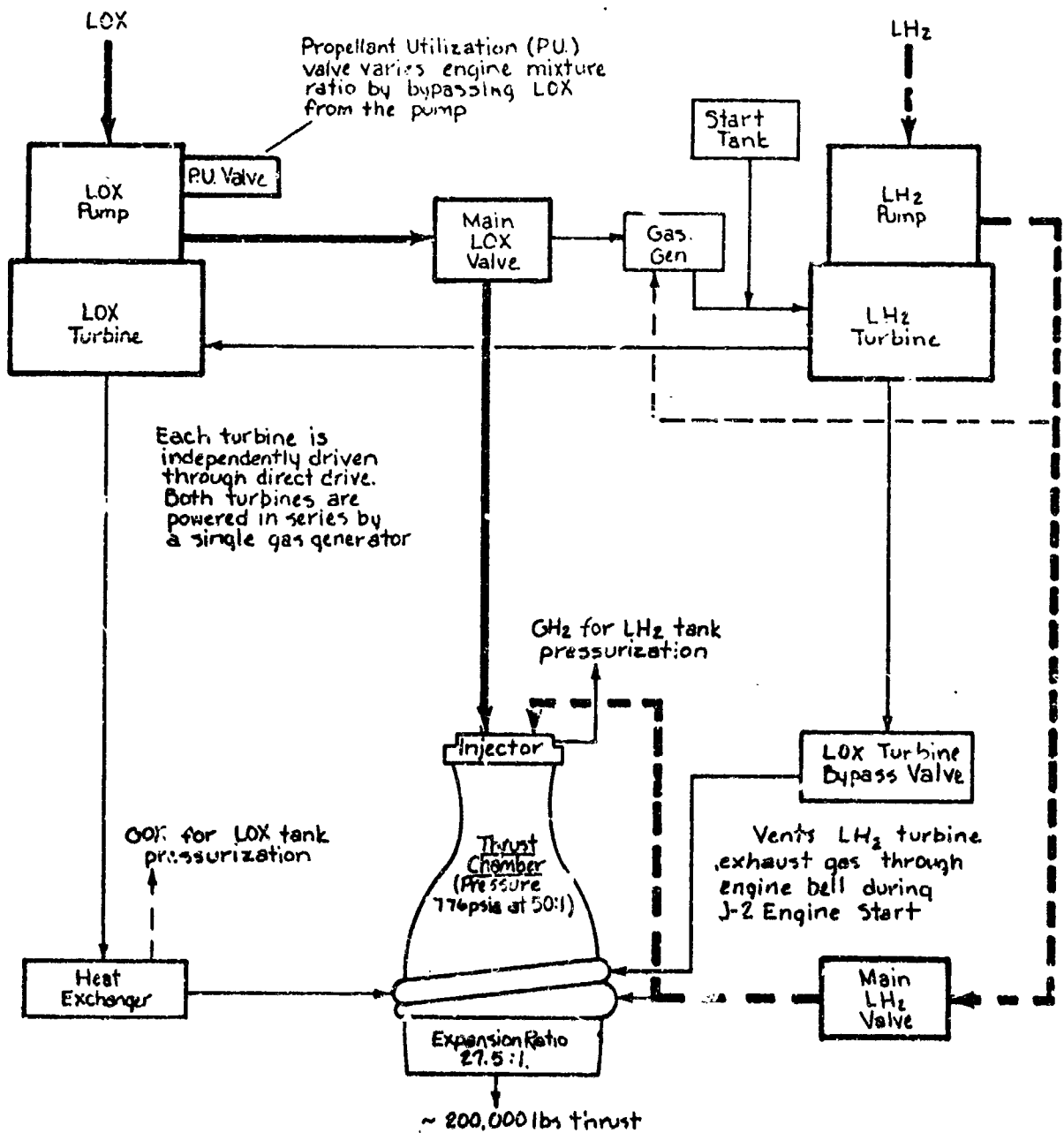

Mixture Ratio  
LOX:LH<sub>2</sub> 5.5-4.5:1

All components shown above are located on the engine

Each of the 5 5-11 J-2 engines is a high performance, high altitude engine utilizing liquid oxygen and liquid hydrogen as propellants and is capable of a single start

5-11  
J-2 Engine System

Figure 29

## S-II STAGE PROPELLANT SYSTEM

The S-II Stage propellant system is composed of integral LOX/LH<sub>2</sub> tanks, propellant lines, control valves, vents, and prepressurization subsystems. Loading of propellant tanks and flow of propellants is controlled by the propellant utilization systems. The LOX/LH<sub>2</sub> tanks are prepressurized by ground source gaseous helium. During powered flight of S-II Stage, the LOX tank is pressurized by GOX bled from the LOX heat exchanger. The LH<sub>2</sub> tank is pressurized by GH<sub>2</sub> bled from the thrust chamber hydrogen injector manifold; pressurization is maintained by the LH<sub>2</sub> Pressure Regulator.

## S-II PROPELLANT LOAD AND OPERATIONAL SEQUENCE

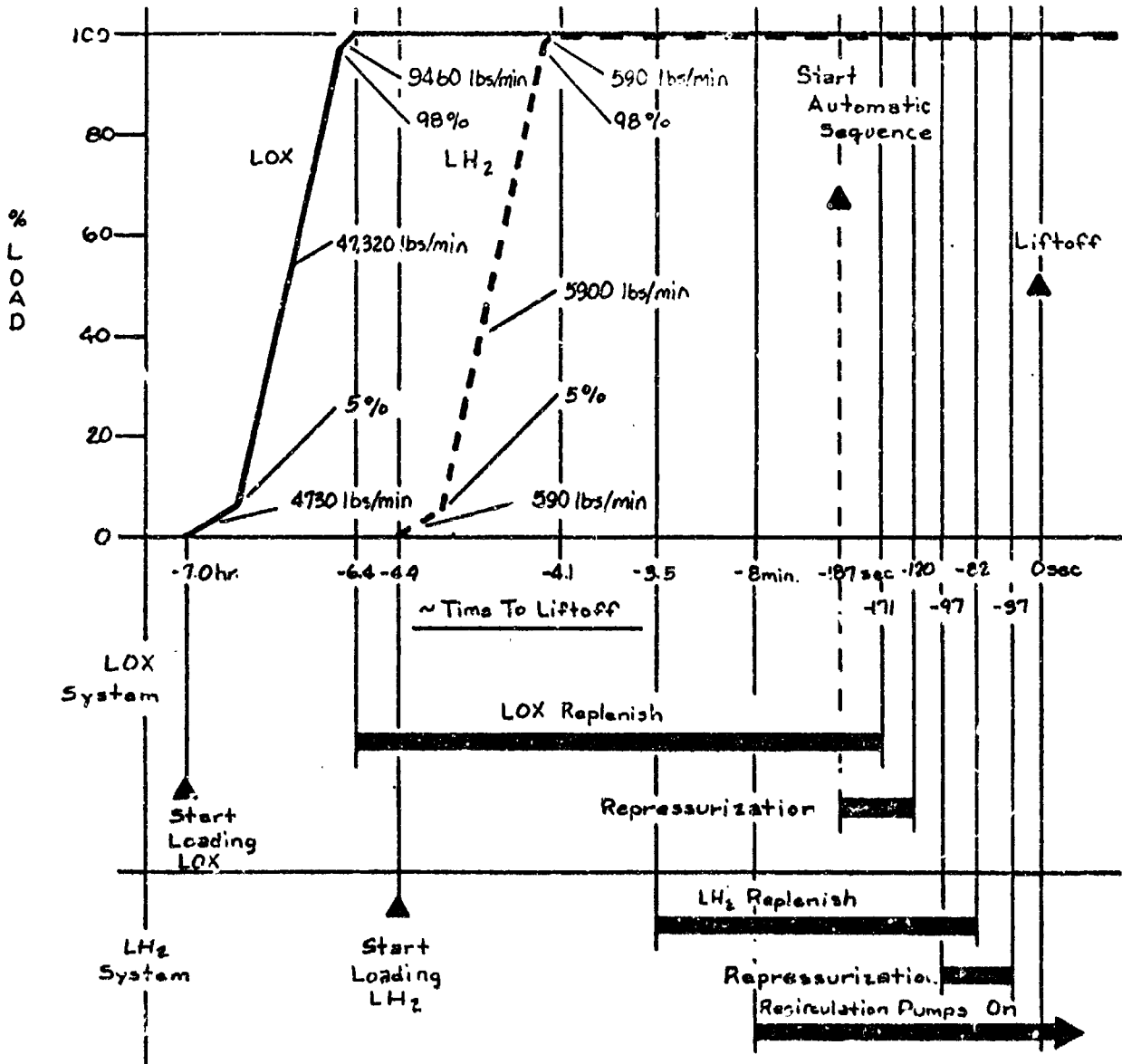

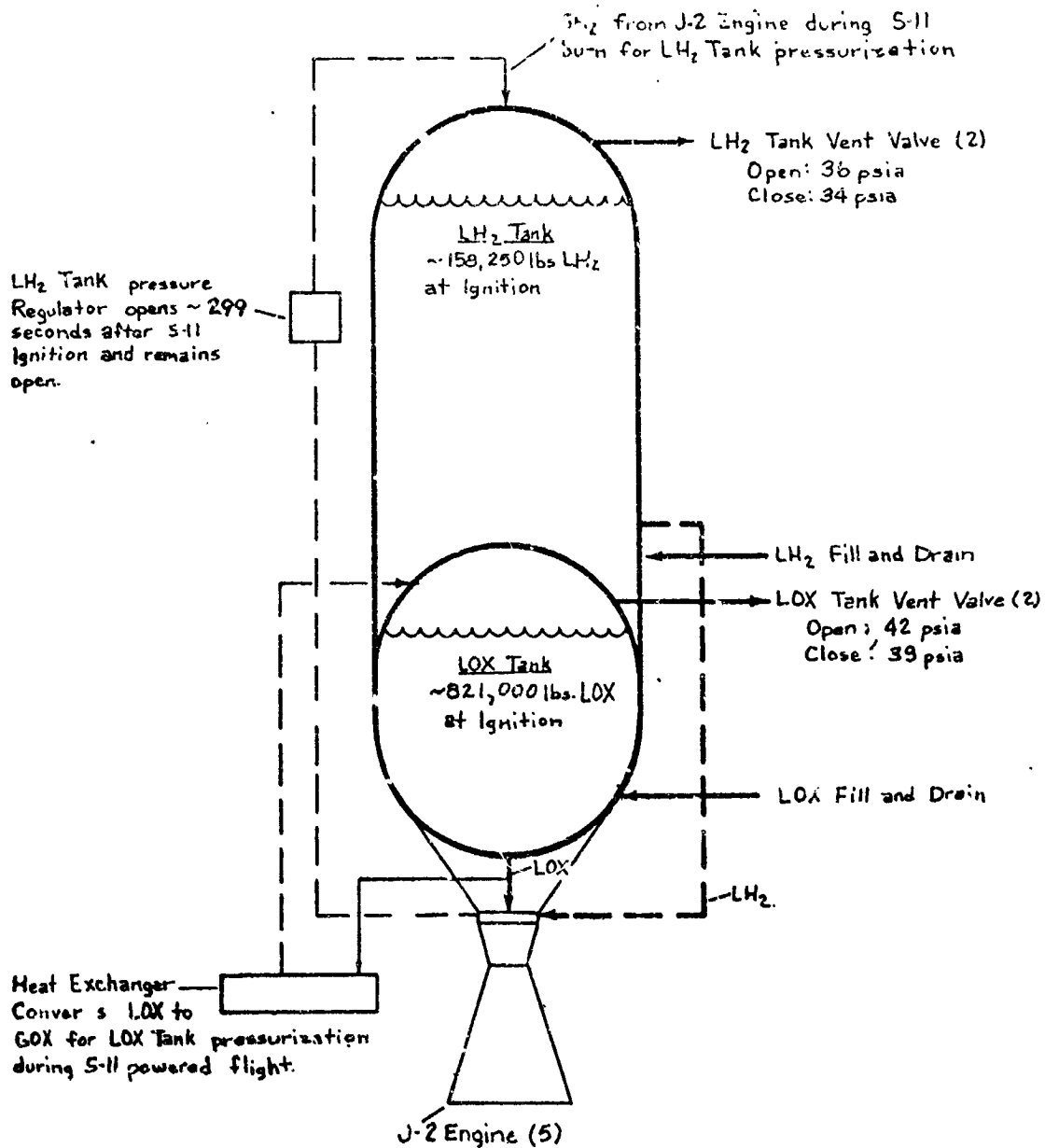

Above LOX and LH<sub>2</sub> lines typical for each engine.

Total propellant at ignition  
 ~979,250 lbs.  
 Total propellant consumed after  
 ignition ~971,450 lbs.

Figure 30

S-11 Propellant System



## S-II STAGE THRUST VECTOR CONTROL SYSTEM

The four outboard J-2 engines are gimbal mounted to provide thrust vector control during powered flight. Attitude control is maintained by gimbaling the outboard engines in response to electrical control signals from the IU flight control computer.

The system consists of four independent closed-loop hydraulic control subsystems which provide power for engine gimbaling. The primary components of the subsystem are an auxiliary pump, a main pump, an accumulator/reservoir manifold assembly and two servo actuators. The auxiliary pump is electrically driven from the GSE to provide hydraulic fluid circulation prior to launch. The main pump is mounted to and driven by the engine LOX turbopump. The accumulator/reservoir manifold assembly consists of a high pressure accumulator which receives high pressure fluid from the pump and a low pressure reservoir which receives return fluid from the servo actuators. The servo actuator is a power control unit that converts electrical signals and hydraulic power into mechanical outputs that gimbal the engine.

During the pre-launch period, the auxiliary hydraulic pump circulates the hydraulic fluid to preclude fluid freezing during propellant loading. Circulation is not required during the S-IC burn due to the short duration burn. After S-IC/S-II separation, an S-II switch selector command unlocks the accumulator lock up valves, releasing high pressure fluid to each of the servo actuators. The accumulators provide gimbaling power prior to the main hydraulic pump operation. During S-II mainstage operation, the main hydraulic pump supplies high pressure fluid to the servo actuators. The return fluid from the actuators is routed to the reservoir which stores hydraulic fluid at sufficient pressure to supply a positive pressure at the main pump inlet.

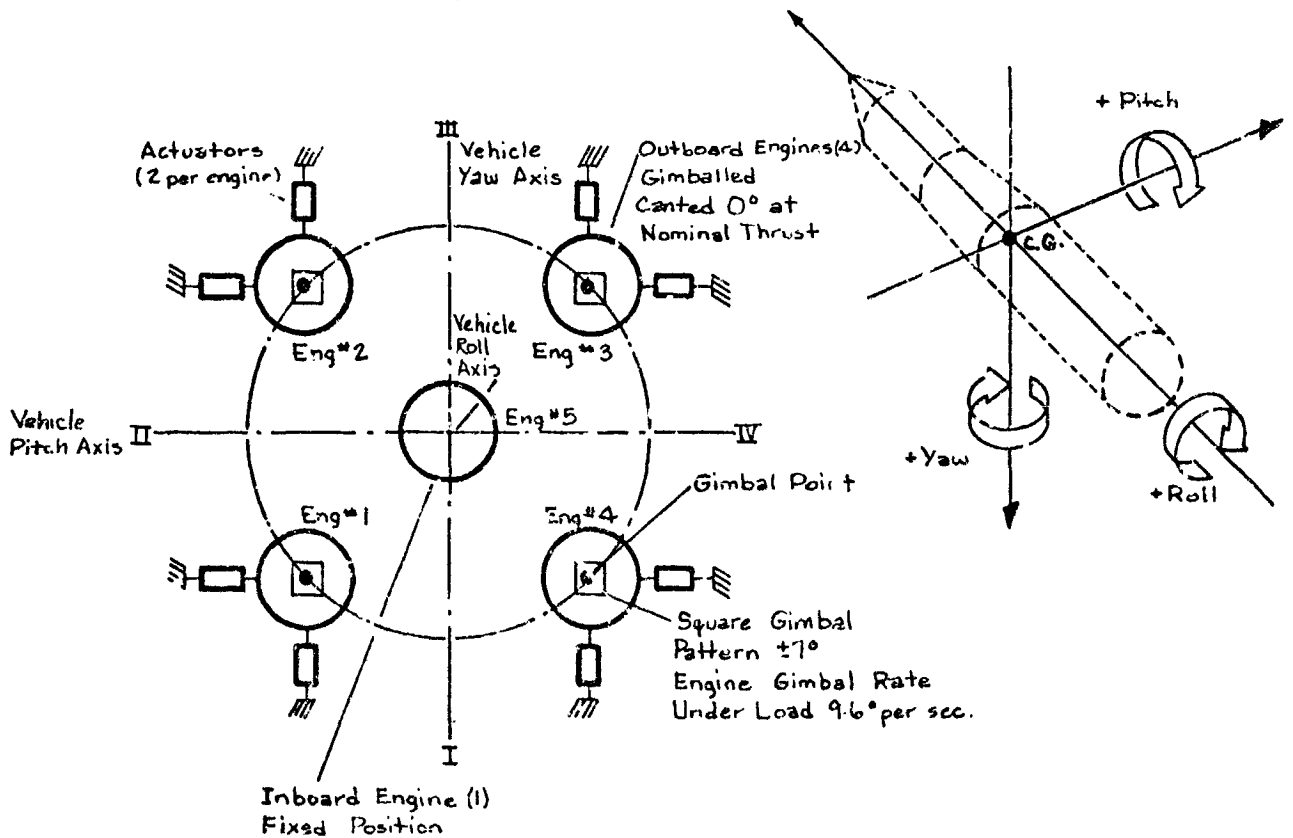
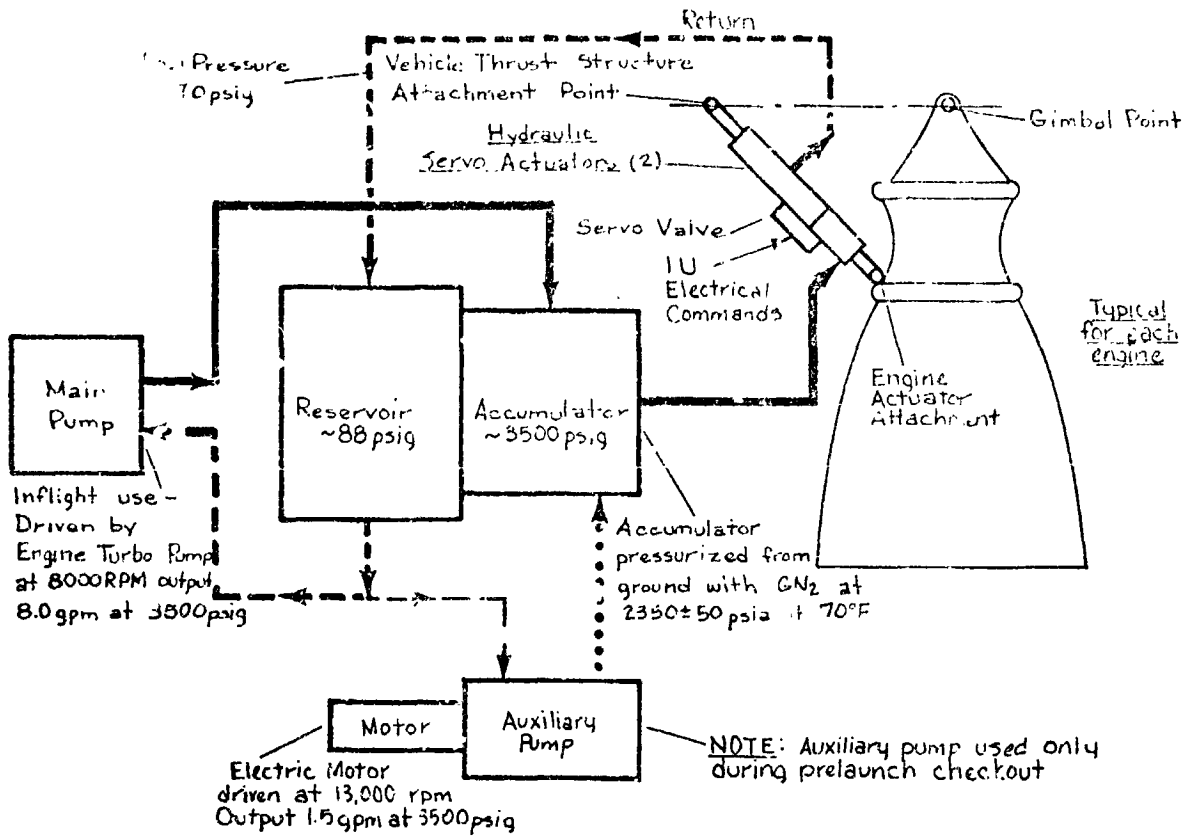

Figure 31

5-11 Thrust Vector Control System

## 5-II STAGE PROPELLANT MANAGEMENT SYSTEM

The propellant management system provides a means for controlling and monitoring propellants during ground loading, powered flight and engine shutdown.

Continuous capacitance probes and point level sensors in the LH<sub>2</sub> and LOX tanks monitor propellant mass. During the propellant loading sequence, a signal from each capacitance probe is transmitted from the on board propellant electronics to GSE to indicate the level of propellants in the tanks. Overfill point level sensors are provided for both the LH<sub>2</sub> and LOX systems. When the propellant mass in the tanks reach a predetermined amount, the GSE loading computer automatically stop the loading sequence.

The propellant utilization (PU) subsystem controls the mixture ratio (MR) of the LOX/LH<sub>2</sub>. The PU subsystem consists of a rotary valve, to control the amount of LOX flowing to the engine, and electrical controls for the valve. At engine start, the PU valve is in a neutral position and supplies a MR of 5.0:1. Approximately 5 seconds after engine start, electrical signals from the LVDC in the IU commands the PU valve to supply a nominal MR of 5.5:1. Five minutes and 20 seconds after engine start the LVDC commands the PU valve to a MR of 4.5:1 for the remainder of the 5-II Stage burn. Capacitance probes in the propellant tanks provide telemetered data to ground stations so that propellant consumption can be monitored.

Center engine shutdown is initiated by a programmed command (timed) from the IU through the 5-II switch selector. Outboard engine shutdown is initiated when any two of the five liquid level sensors in either propellant tank indicate propellant depletion.

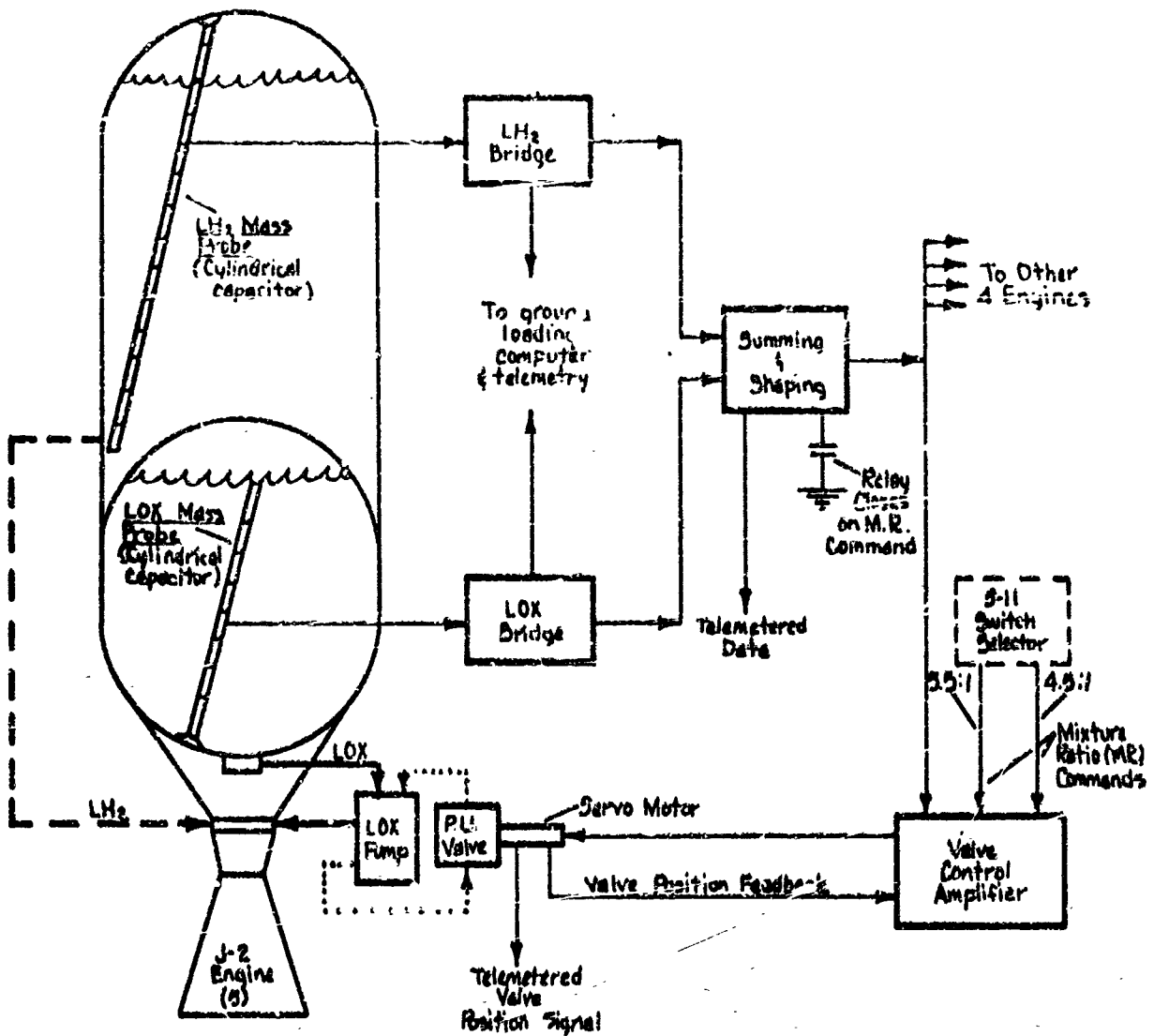

5-11 Propellant Utilization (PU) Timeline

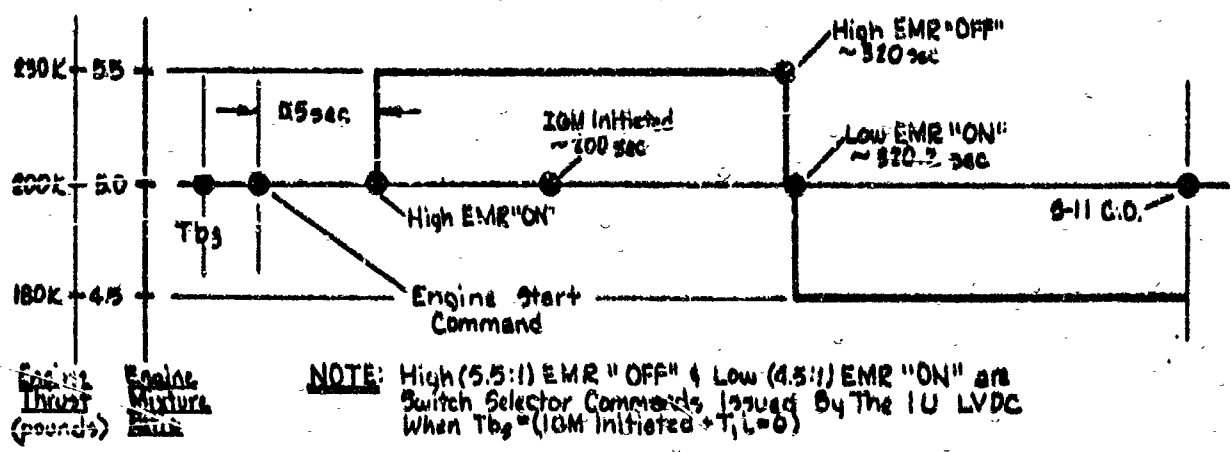

Figure 96

5-11 Propellant Management System

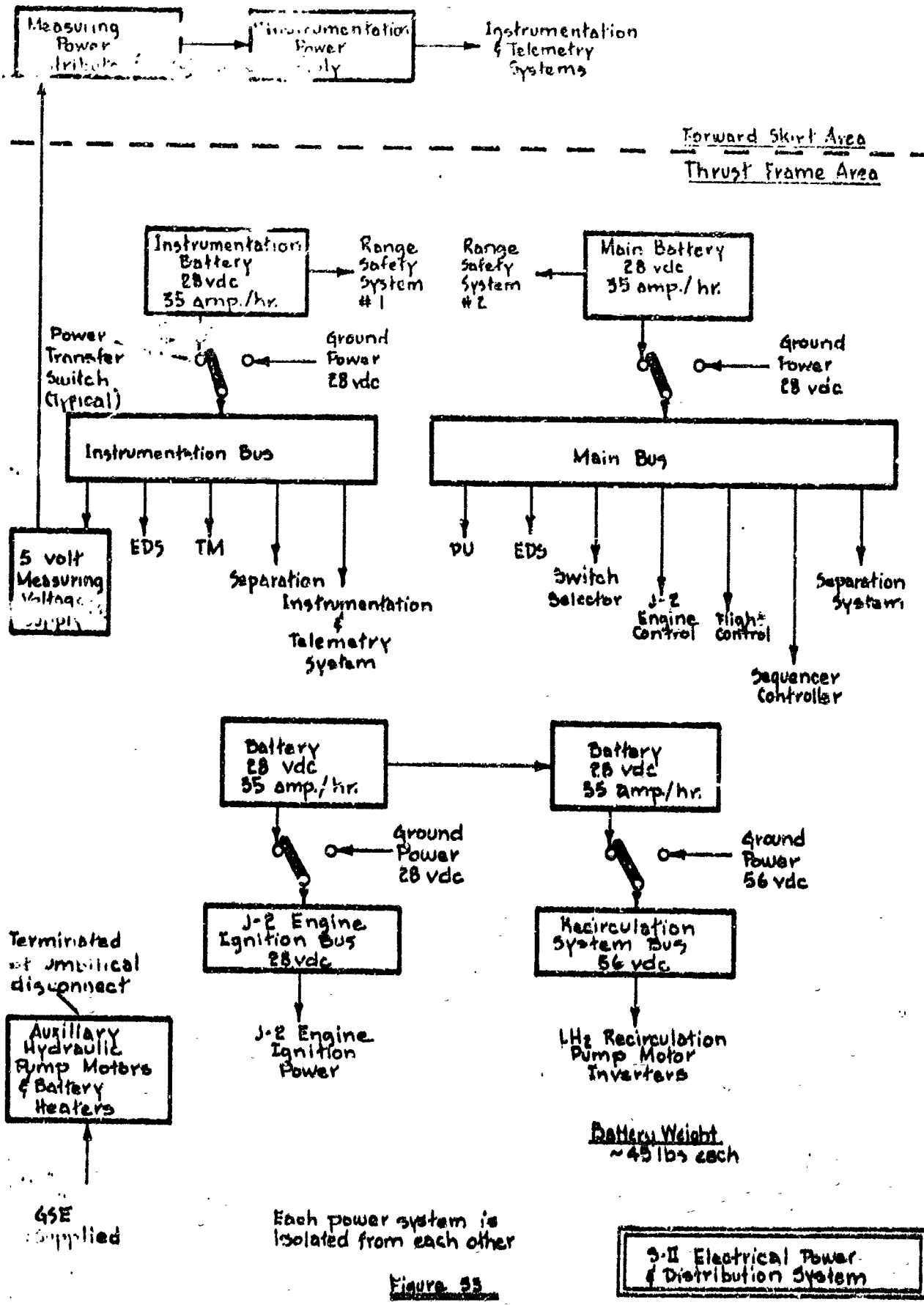

Figure 55

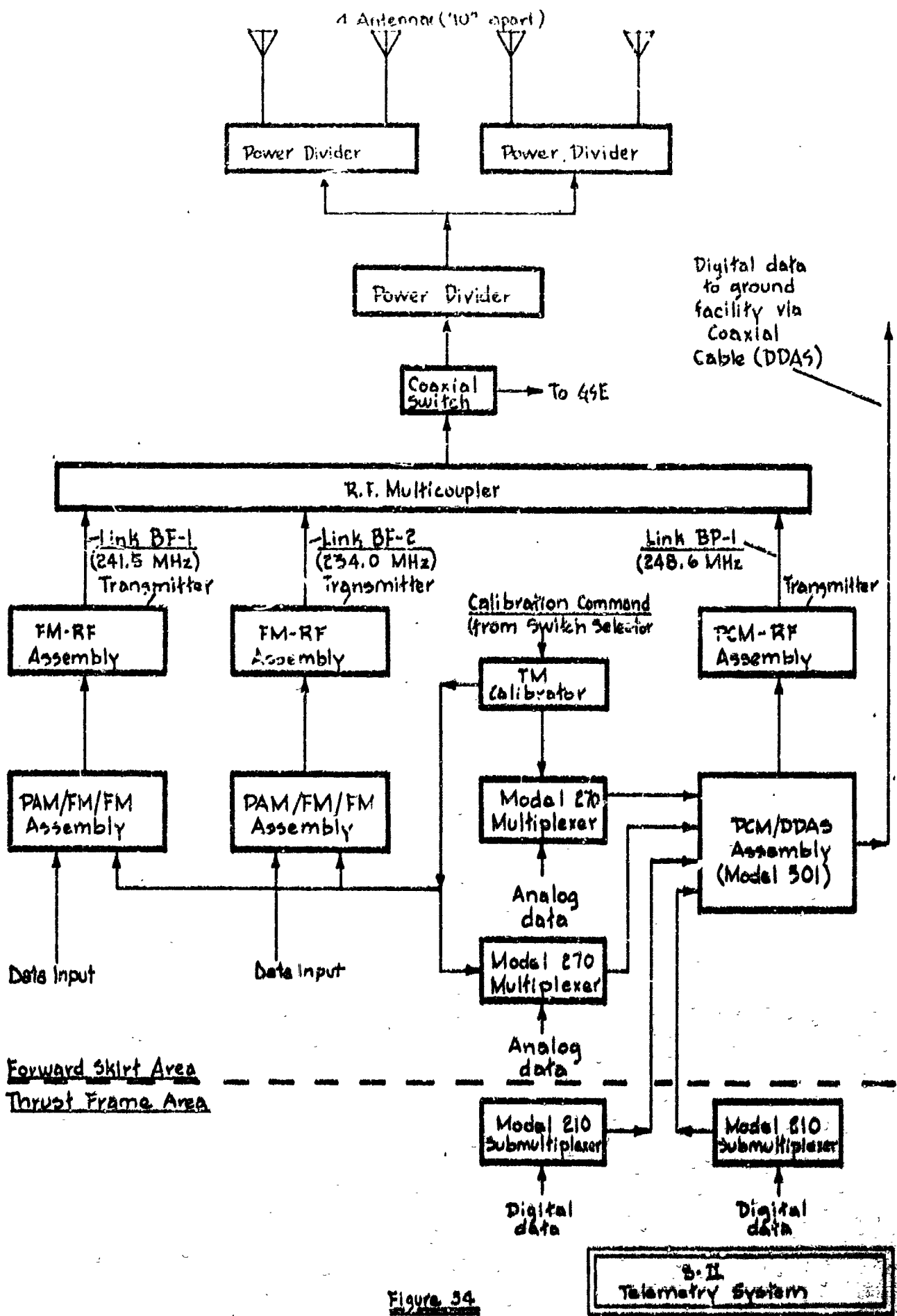

Figure 34

## S-IVB STAGE STRUCTURE

The S-IVB, the third booster stage, is approximately 59 feet in length with a stage weight at ground liftoff of approximately 262,150 pounds. The S-IVB stage is powered by a single J-2 engine capable of providing 232,000 pounds of thrust at first burn and 211,000 pounds during second burn.

### The Forward Skirt Assembly

The forward skirt is the load supporting member between the LH<sub>2</sub> tank and the Instrument Unit. The forward umbilical plate, antennas, the LH<sub>2</sub> flight vents and tunnel fairings are attached externally to this skirt.

### Propellant Tank Assembly

The propellant tank assembly is a cylindrical aluminum structure with a hemispherical shaped dome at each end. LOX and LH<sub>2</sub> are separated by a common bulkhead of sandwich type construction which is bonded to and separated by a fiberglass-phenolic honeycomb core.

### LH<sub>2</sub> Tank

The internal surface of the LH<sub>2</sub> tank is a machined, waffle-like pattern to provide structural rigidity. Polyurethane insulation blocks, covered with fiberglass and a sealant coating, are bonded to the intertank waffle-like pattern to minimize LH<sub>2</sub> boiloff. The LH<sub>2</sub> tank is equipped internally with a slosh baffle, propellant utilization probe, temperature and level sensors and fill, pressurization and vent pipes.

### LOX Tank

The LOX tank is located in the aft end of the propellant structure and is surrounded by the aft skirt assembly. The LOX tank is equipped internally with a slosh baffle, a chilldown pump, a 13.5 foot propellant utilization probe, temperature and level sensors, and fill, pressurization and vent pipes.

### Aft Skirt Assembly

The aft skirt assembly is the load bearing structure between the LOX tank and the aft interstage.

### Thrust Structure

The thrust structure is an inverted, truncated cone attached at its larger end to the aft dome of the LOX tank and at the smaller end to the J-2 engine mount.

### Aft Interstage

The aft interstage is a truncated cone that provides a load support structure between the S-II and the S-IVB stages. S-II retro rocket mounts are attached to this stage. The aft interstage remains with the S-II at interstage separation.

Access door in the IU allows servicing of the equipment in the forward skirt

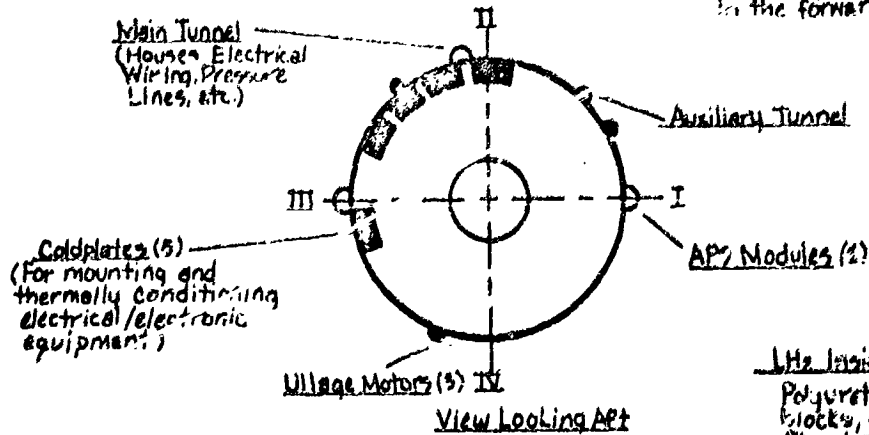

LH<sub>2</sub> Inside Tank Insulation  
 Polyurethane insulation blocks, covered with a fiberglass sheet and coated with a sealant

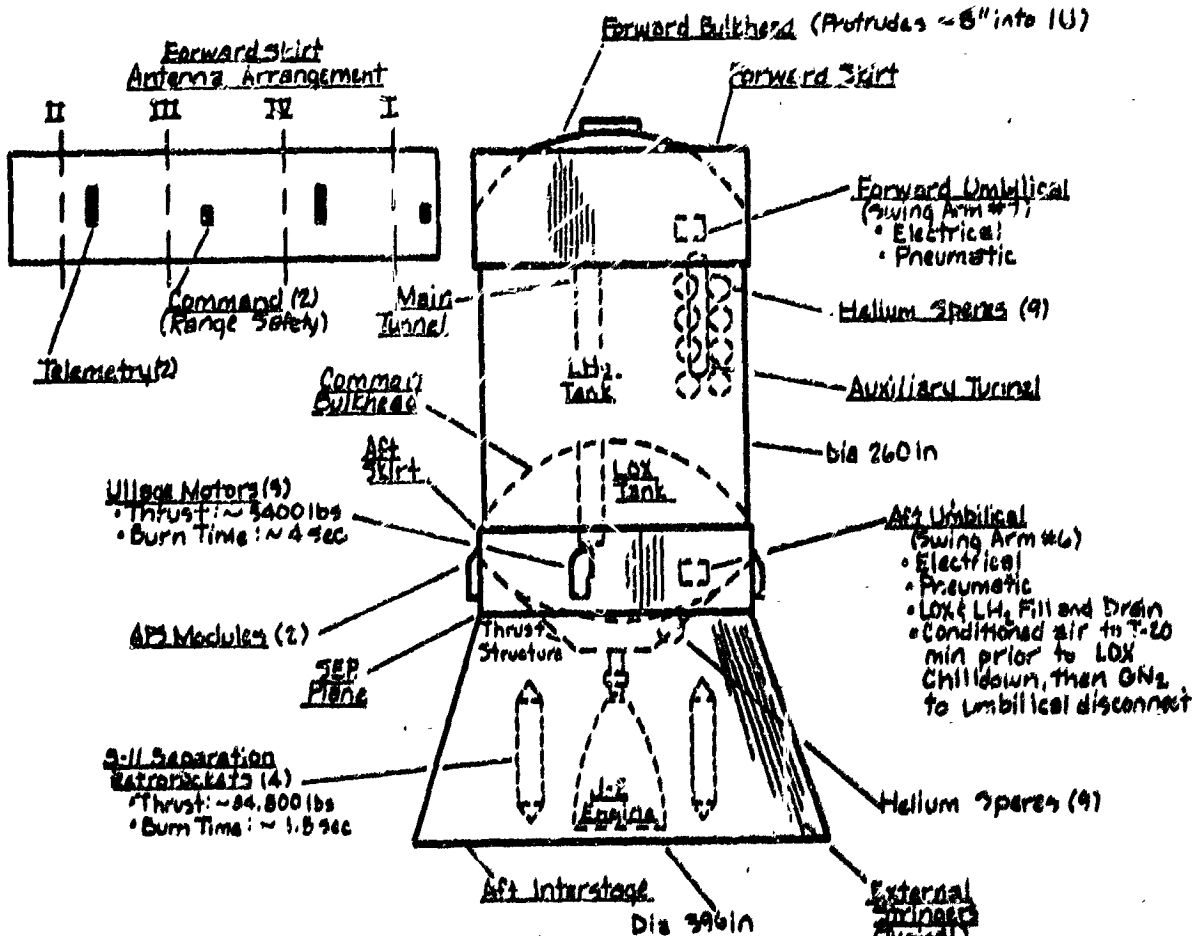

- 3-IVB Stage Weights**
- Dry: ~23,000 lbs
  - At 3-IVB Ignition: ~261,800 lbs
  - At 3-IVB Cutoff: ~192,400 lbs
  - At 3-IVB 2nd Cutoff: ~28,800 lbs
  - At 3-IVB Sep: ~28,300 lbs

3-IVB Configuration

Figure 29



**J-2 ENGINE OPERATION S-1V8 STAGE**

The operating cycle of the J-2 Engine consists of prestart, start, steady-state operation and cutoff sequences. During prestart, LOX and LH<sub>2</sub> flow through the engine to temperature-condition the engine components, and to assure the presence of propellant in the turbopumps for starting. Following a timed cool-down period, the start signal is received by the sequence controller which energizes various control solenoid valves to open the propellant valves in the proper sequence. The sequence controller also energizes spark plugs in the gas generator and thrust chamber to ignite the propellant. In addition, the sequence controller releases GH<sub>2</sub> from the start tank. The GH<sub>2</sub> provides the initial drive for the turbopumps that deliver propellant to the gas generator and the engine. The propellant ignites, gas generator output accelerates the turbopumps, and engine thrust increases to main stage operation. At this time, the spark plugs are de-energized and the engine is in steady-state operation.

Steady-state operation is maintained until a cutoff signal is received by the sequence controller. The sequence controller de-energizes the solenoid valves which in turn close the engine propellant valves in the proper sequence. As a result, engine thrust decays and the cutoff sequence is complete.

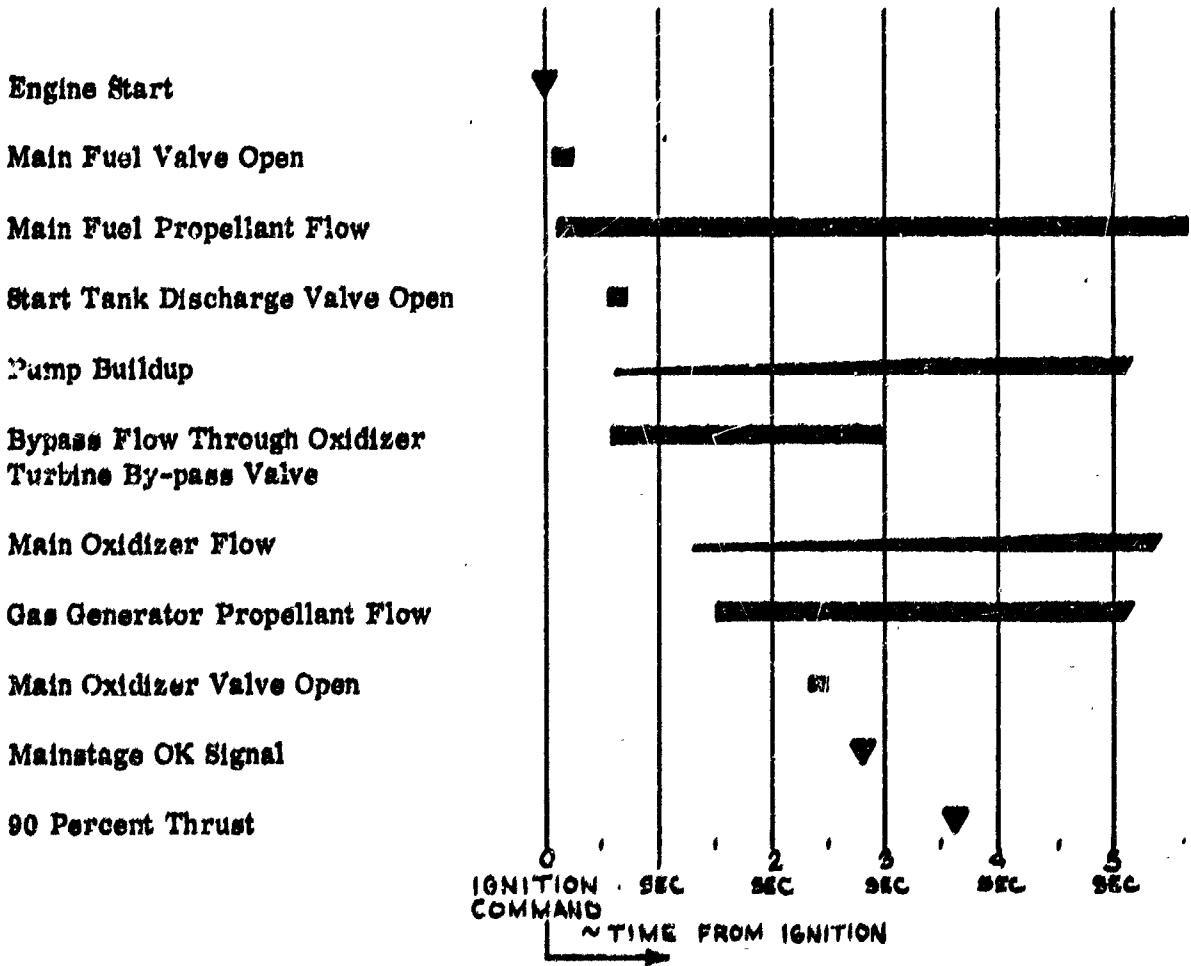

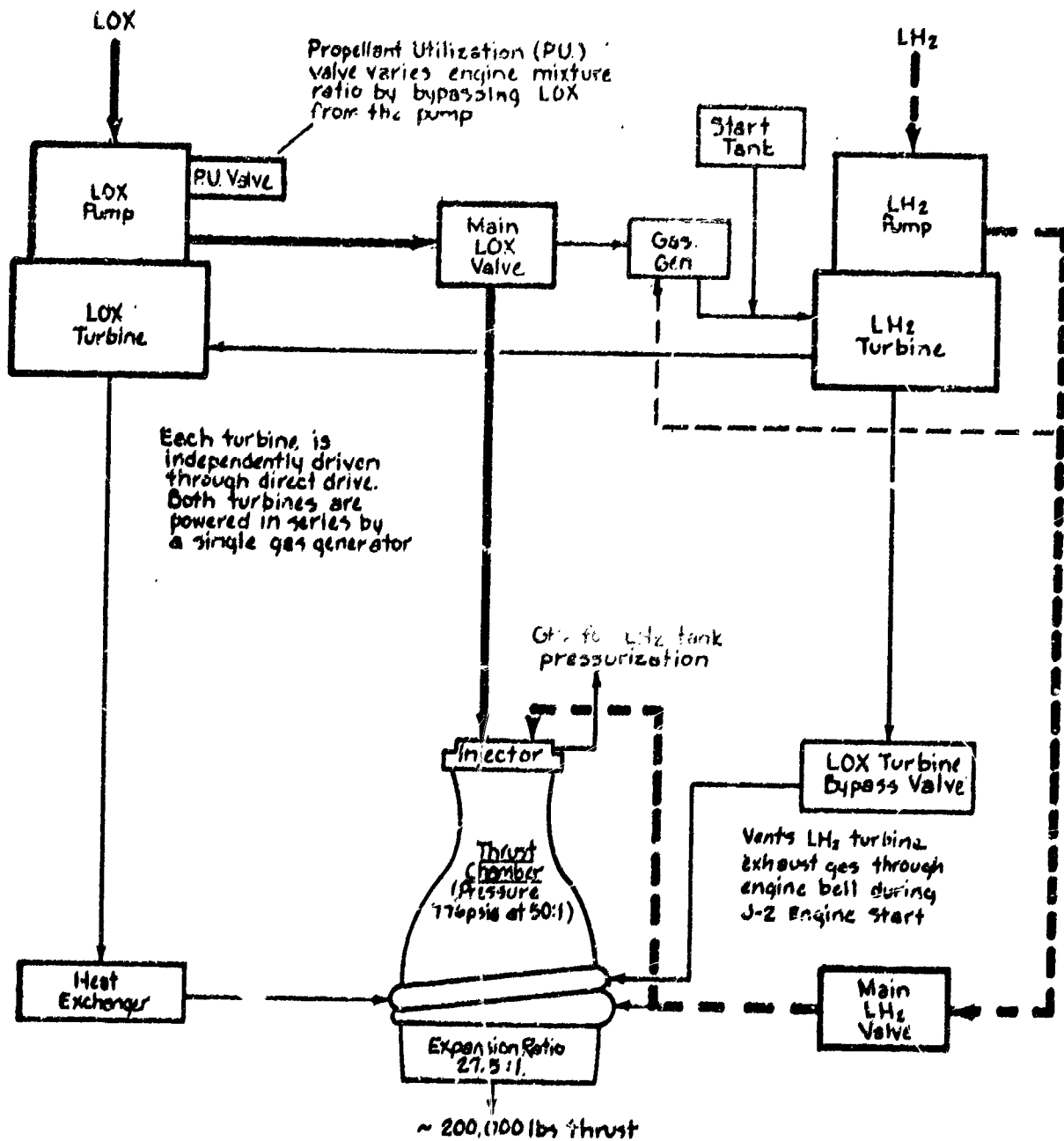

Mixture Ratio  
LOX:LH<sub>2</sub> 5.5-4.5:1

All components shown above are located on the engine

The 3-IVB J-2 engine is a high performance, high altitude engine utilizing liquid oxygen and liquid hydrogen as propellants and is capable of multiple restarts

Figure 36

4-IVB  
J-2 Engine System

## S-IVB STAGE PROPELLANT SYSTEM

The S-IVB stage propellant system is composed of integral LOX/LH<sub>2</sub> tanks, propellant lines, control valves, vents and pressurization subsystems. Loading of the propellant tanks and flow of propellants is controlled by the propellant utilization system. Both propellant tanks are initially pressurized by ground source cold helium.

LOX tank pressurization during S-IVB stage burn is maintained by helium supplied from spheres in the LH<sub>2</sub> tank, which is expanded by passing through the heat exchanger, to maintain positive pressure across the common tank bulkhead and to satisfy engine net positive suction head. LH<sub>2</sub> tank pressurization during S-IVB stage burn is maintained by GH<sub>2</sub> from the J-2 engine injector. Pressurization of the LH<sub>2</sub> tank strengthens the stage in addition to satisfying engine net positive suction head.

Repressurization of the propellant tanks, prior to J-2 engine restarts, is attained by passing cold helium, from the helium spheres in the LH<sub>2</sub> tank, through the O<sub>2</sub>/H<sub>2</sub> burner. The heated helium is then routed to the propellant tanks. Should the O<sub>2</sub>/H<sub>2</sub> burner fail, ambient repressurization will ensure propellant tank pressure for engine restarts.

## S-IVB PROPELLANT LOAD AND OPERATIONAL SEQUENCE

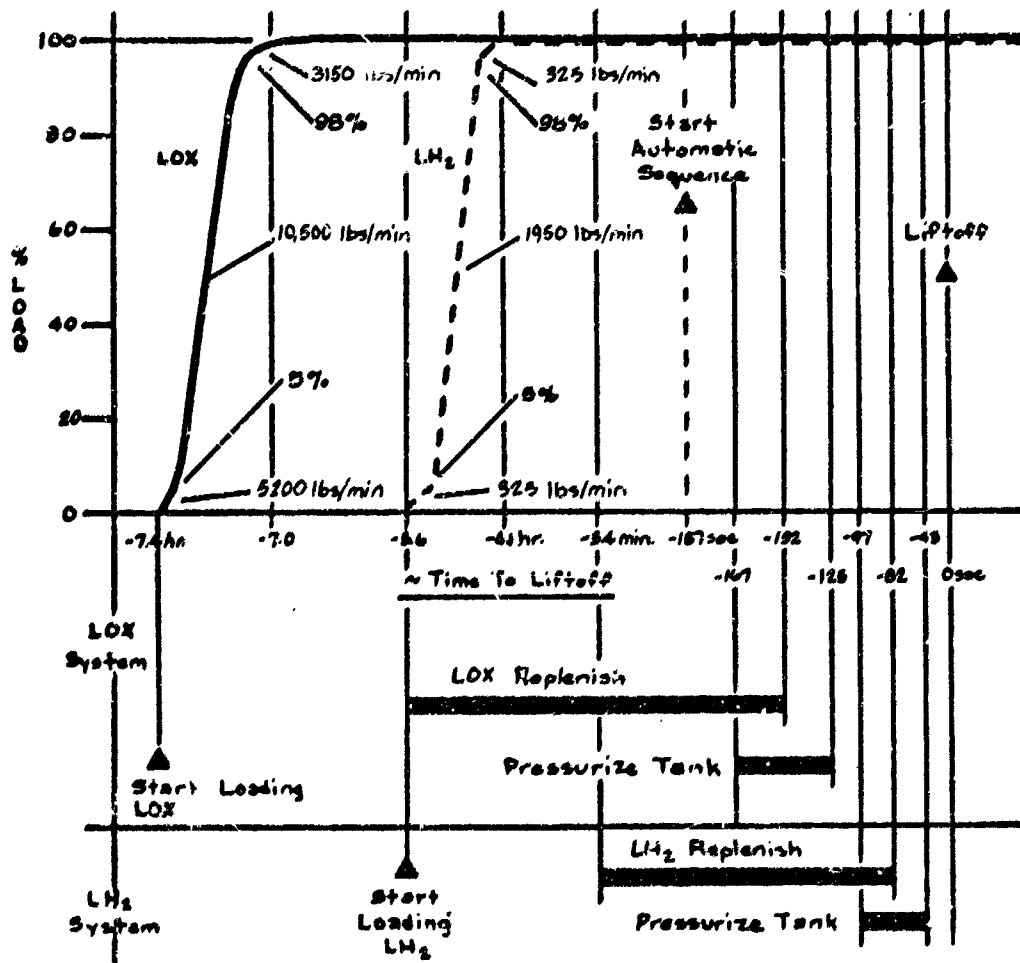

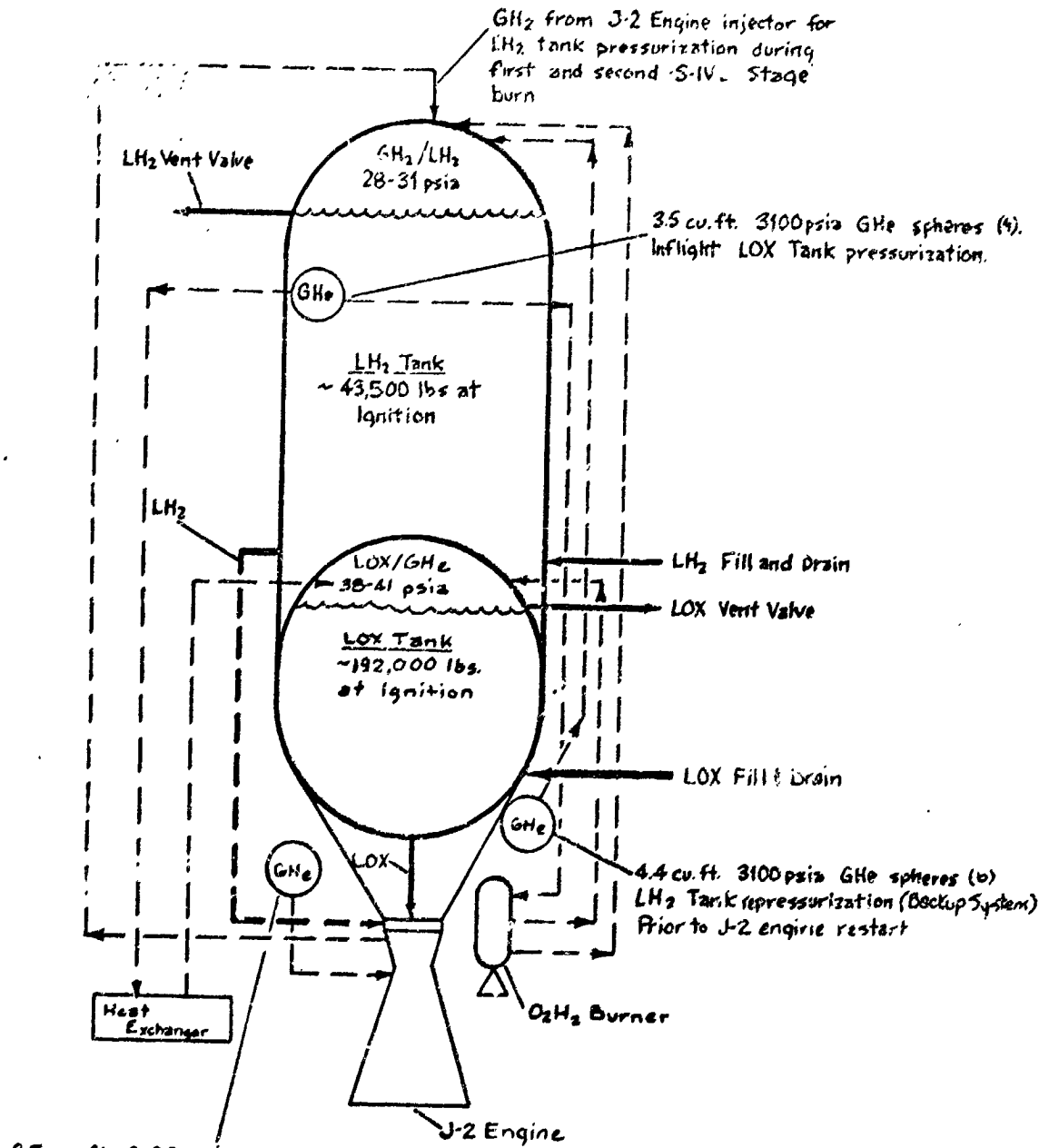

35 cu ft 3100 psia GHe spheres (2) for J-2 engine pneumatic system

Total propellant at ignition ~ 235,500 lbs.  
 Total propellant consumed after ignition ~ 223,900 lbs.

Figure 37

S-IVB Propellant System

### S-IVB THRUST VECTOR CONTROL SYSTEM

The single J-2 Engine is gimballed mounted on the longitudinal axis of the S-IVB Stage to provide pitch and yaw control during S-IVB powered flight. Engine gimballing is accomplished by an independent closed loop hydraulic system which supplies power to the two servo-actuators. The two servo-actuators may extend or retract individually or simultaneously. Gimbal position is proportional to the magnitude of an electrical input to the electro-hydraulic servo valve located on each actuator. Mechanical feedback from the actuator to the servo valve completes the closed engine position loop.

During S-IC and S-II stage burns, the actuators hold the engine position to null. This is accomplished by utilizing the electrically driven auxiliary hydraulic pump. The auxiliary hydraulic pump is also used during orbit to periodically circulate the hydraulic fluid to prevent freezing. During the S-IVB burn, the main hydraulic pump, driven by the engine, provides the necessary pressure and circulation for actuator operation (pitch and yaw control). Roll control is provided by the Auxiliary Propulsion System (see page 71).

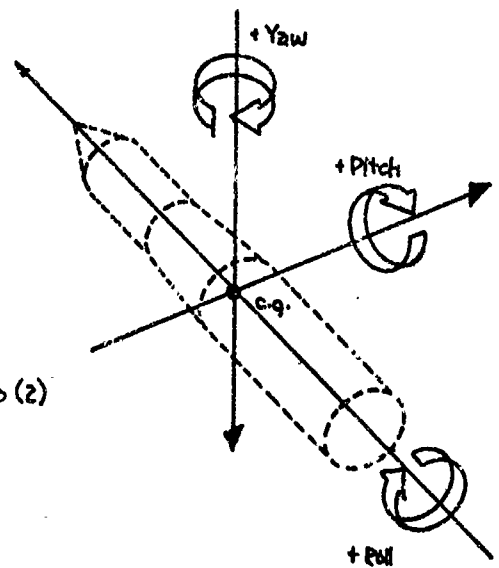
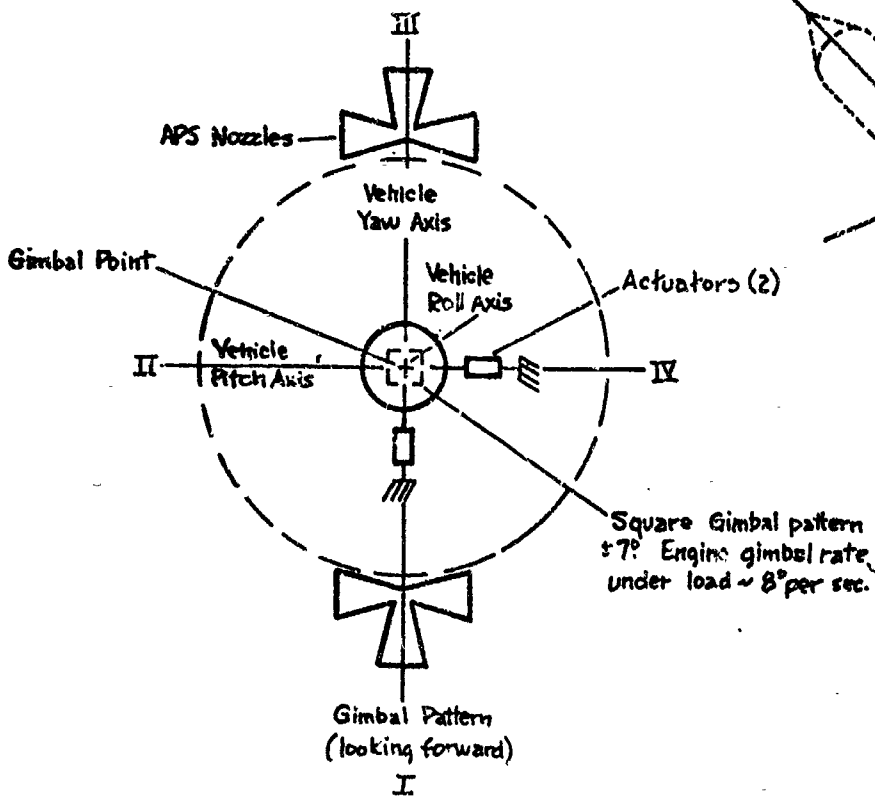
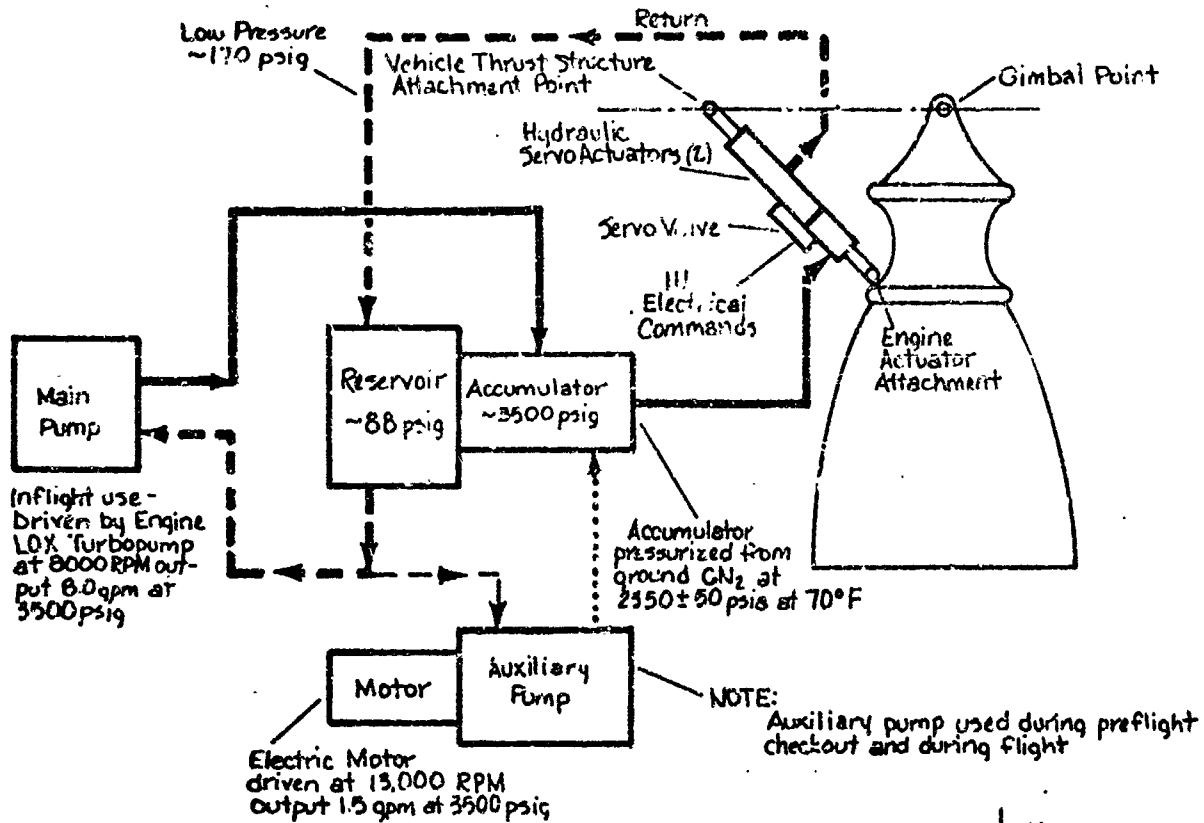

S-108 Thrust Vector Control System

Figure 3B

## AUXILIARY PROPULSION SYSTEM

The S-IVB Auxiliary Propulsion System (APS) provides vehicle attitude control during powered flight in the roll axis only and during S-IVB coast provides control in the pitch, yaw, and roll axes. Attitude corrections are made by firing the control engines, individually or in combination, in short bursts of approximately 65 ms minimum duration. Commands from the Flight Control Computer actuate fuel and oxidizer solenoid valve clusters that admit hypergolic propellants to the control engine combustion chambers.

The attitude control engines are located in two aerodynamically shaped modules, 180 degrees apart, on the aft end of the S-IVB stage (positions I and III). Each module contains four hypergolic engines, three 150 pound thrust attitude control engines and one 70 pound thrust ullage engine. The 70 pound thrust (ullage) engine in each module is used to settle the main stage propellants after S-IVB cutoff and again prior to restart. One control engine of each module is used to control the vehicles' attitude in pitch, while the other two are used for yaw and roll control.

Each APS module contains its own propellant supply and pressurization system. The hypergolic propellants used by the engines are monomethyl hydrazine (MMH) for the fuel and nitrogen tetroxide ( $N_2O_4$ ) for the oxidizer. Helium is the pressurant used in the system.

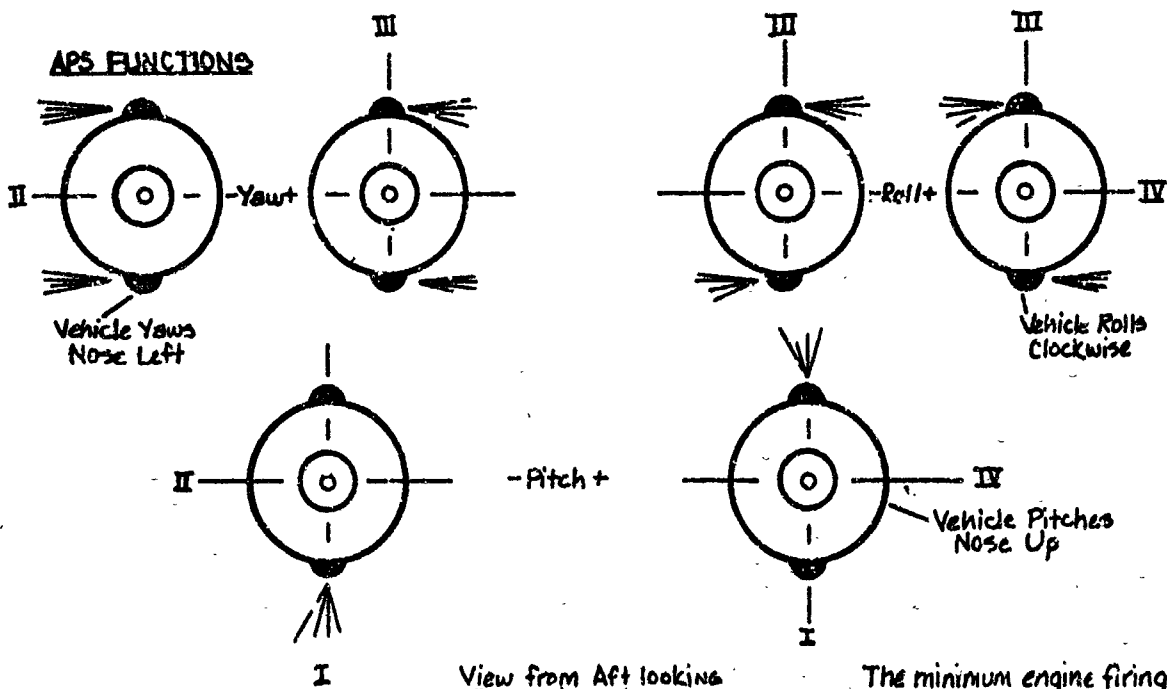
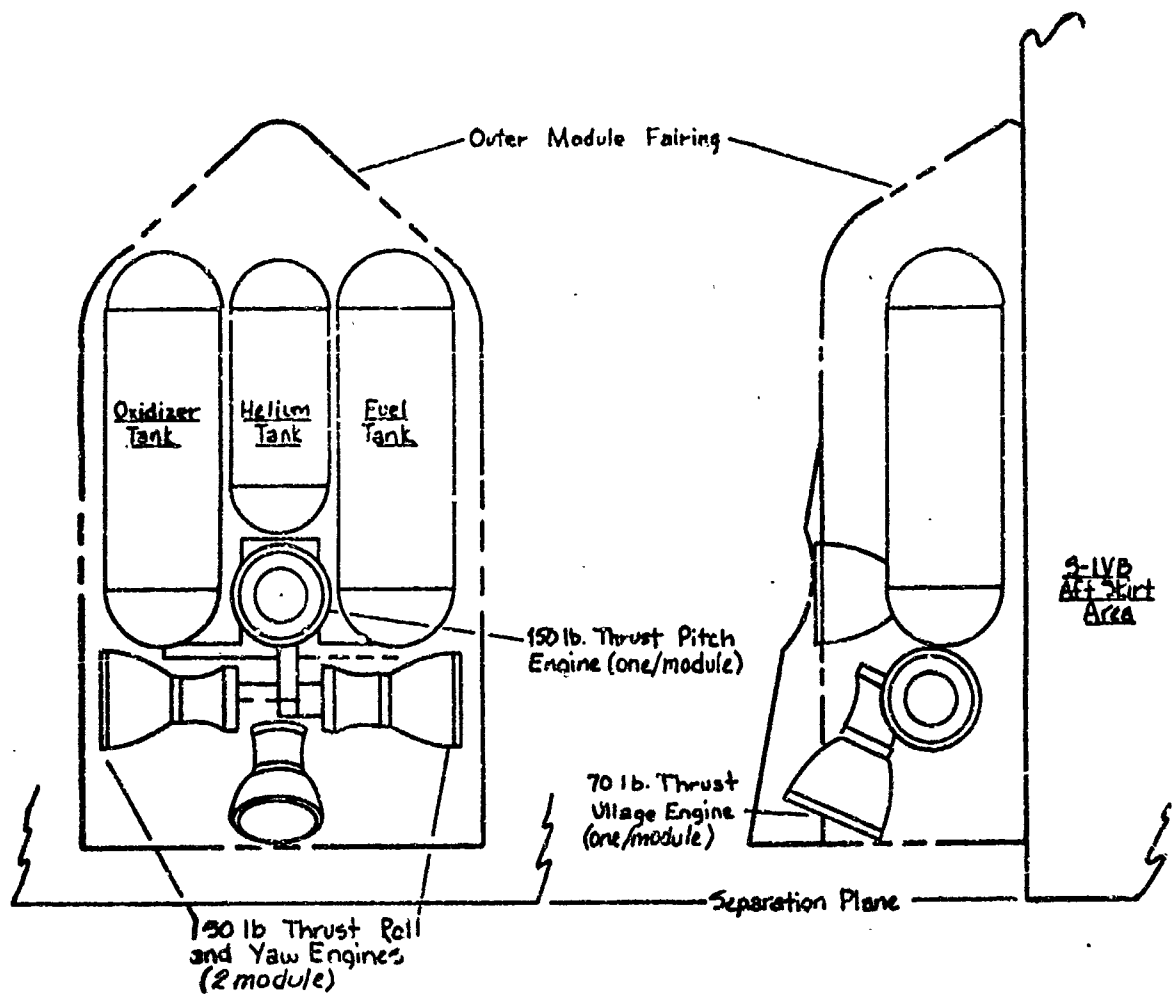

Figure 39

3-IVB  
Auxiliary Propulsion System



## S-IVB STAGE PROPELLANT MANAGEMENT SYSTEM

The propellant management system provides a means for controlling and monitoring propellants during ground loading, powered flight and engine shutdown.

Continuous capacitance probes and point level sensors in the LOX and LH<sub>2</sub> tanks monitor propellant mass. During the propellant loading sequence, a signal from each capacitance probe is transmitted from the on board propellant electronics to GSE to indicate the level of propellants in the tanks. Overfill point level sensors are provided for LOX and LH<sub>2</sub> systems. When the propellant mass in the tanks reach a predetermined amount, the GSE loading computer automatically stops the loading sequence.

The propellant utilization (PU) subsystem controls the mixture ratio (MR) of the LOX/LH<sub>2</sub>. The PU subsystem consists of a rotary valve, to control the amount of LOX flowing to the engine, and electrical controls for the valve. The MR is controlled by the switch selector outputs which are used to operate the PU valve.

Prior to engine start the PU valve is commanded to the neutral position to obtain a MR of 5.0:1. The PU valve remains at the 5.0:1 position during the first burn. Prior to engine restart (first opportunity) the PU valve is commanded by the switch selector to a MR of 4.5:1 and remains at this position for approximately one minute and 55 seconds of the S-IVB burn. The PU valve is then commanded to the neutral position (5.0:1). If the S-IVB restart is delayed to the second opportunity, the MR is shifted from 4.5:1 to 5.0:1 when the engine reaches 90 percent thrust.

Engine shutdown, during first burn, is initiated by a programmed command (velocity) from the IU through the switch selector. Engine shutdown after second burn is initiated by a programmed command (velocity) from the IU through the S-IVB switch selector. Backup shutdown is provided by any two of the five liquid level sensors in either propellant tank indicating propellant depletion.

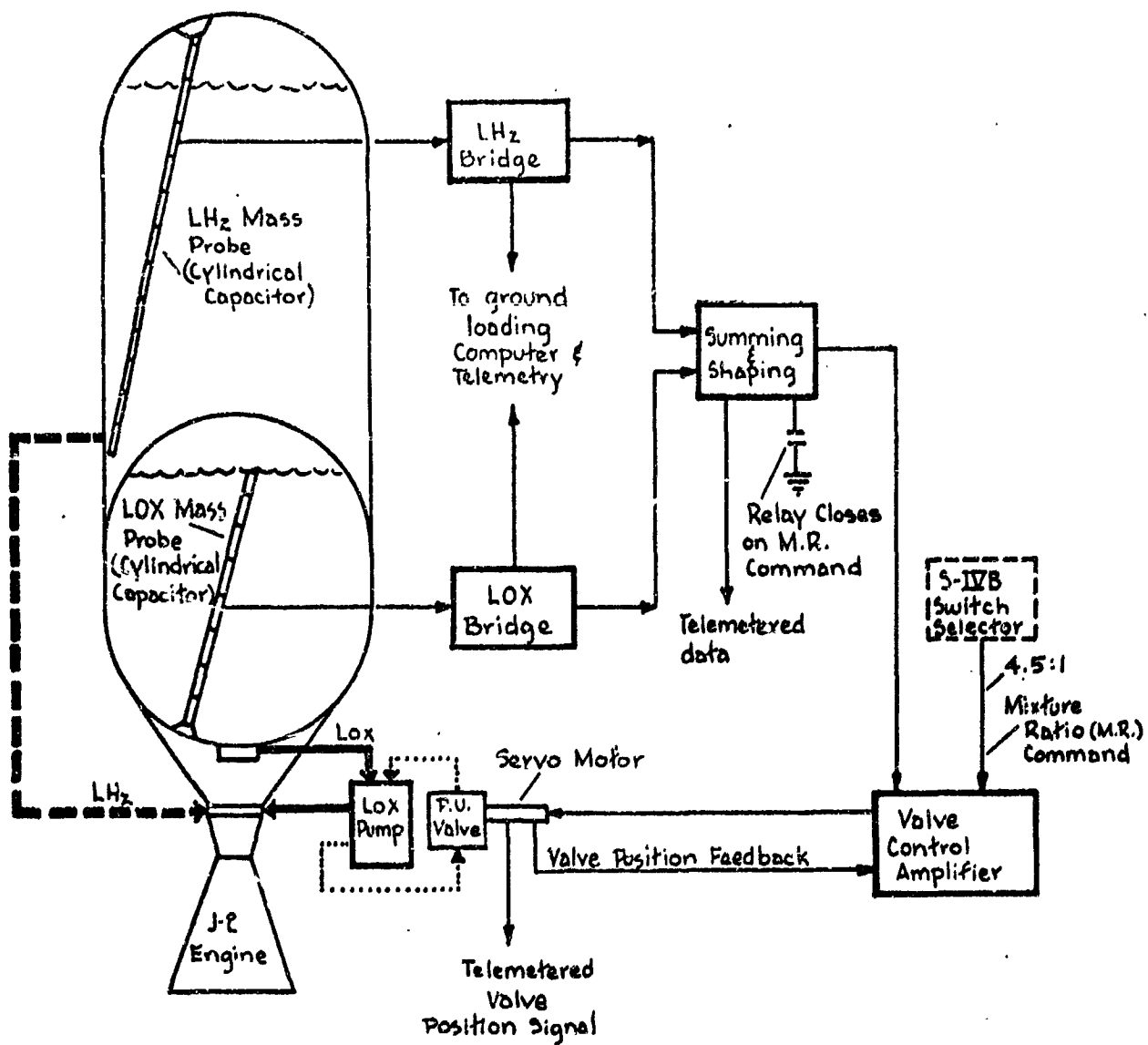

5-IVB Propellant Utilization (P.U.) Timeline  
For 5-IVB Second Burn

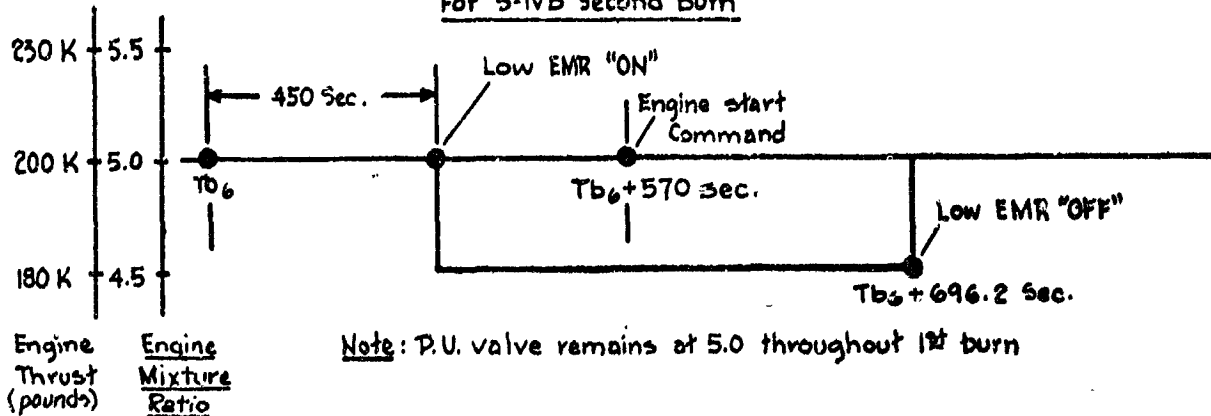

Figure 40

5-IVB Propellant Management System

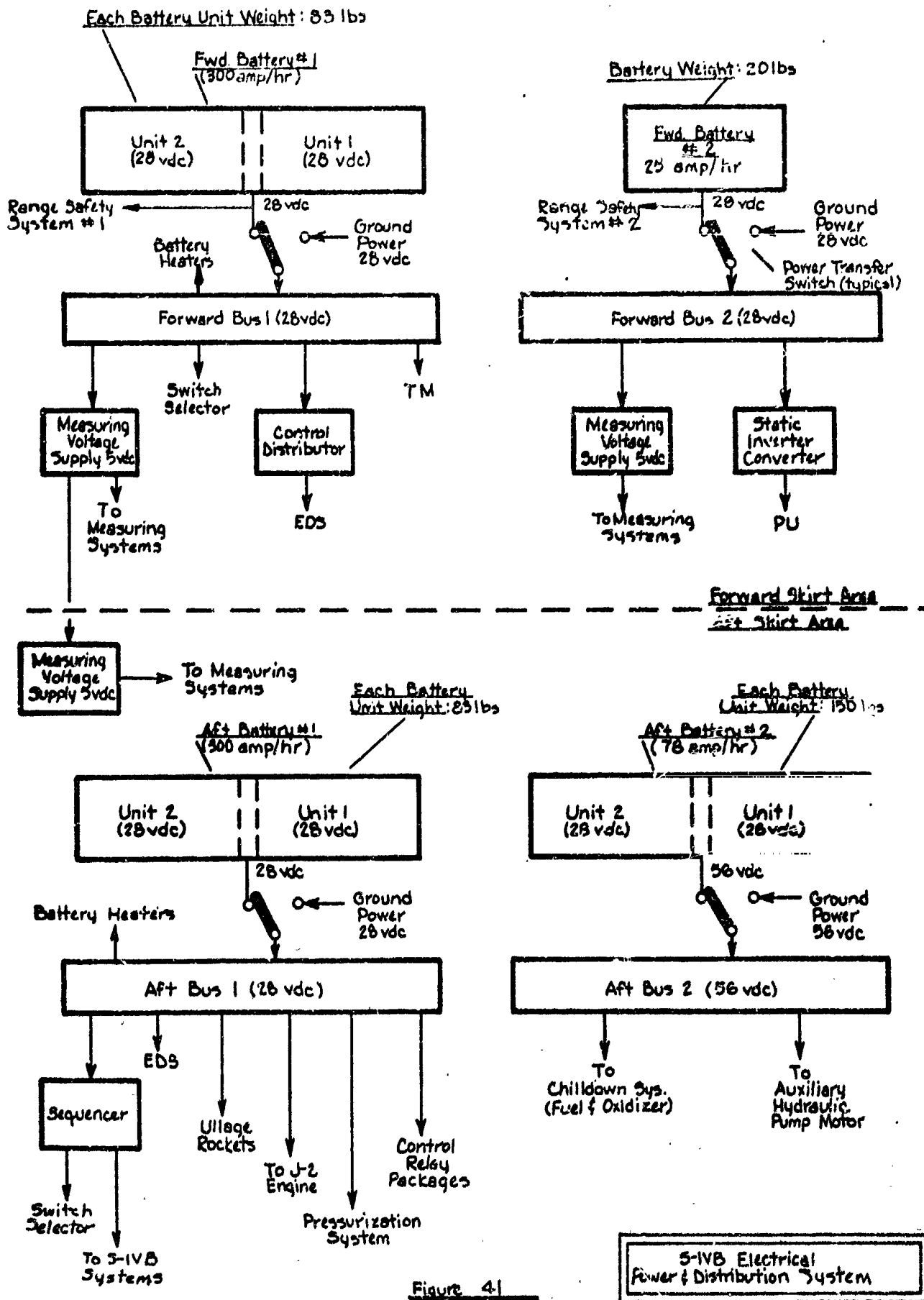

Figure 4-1

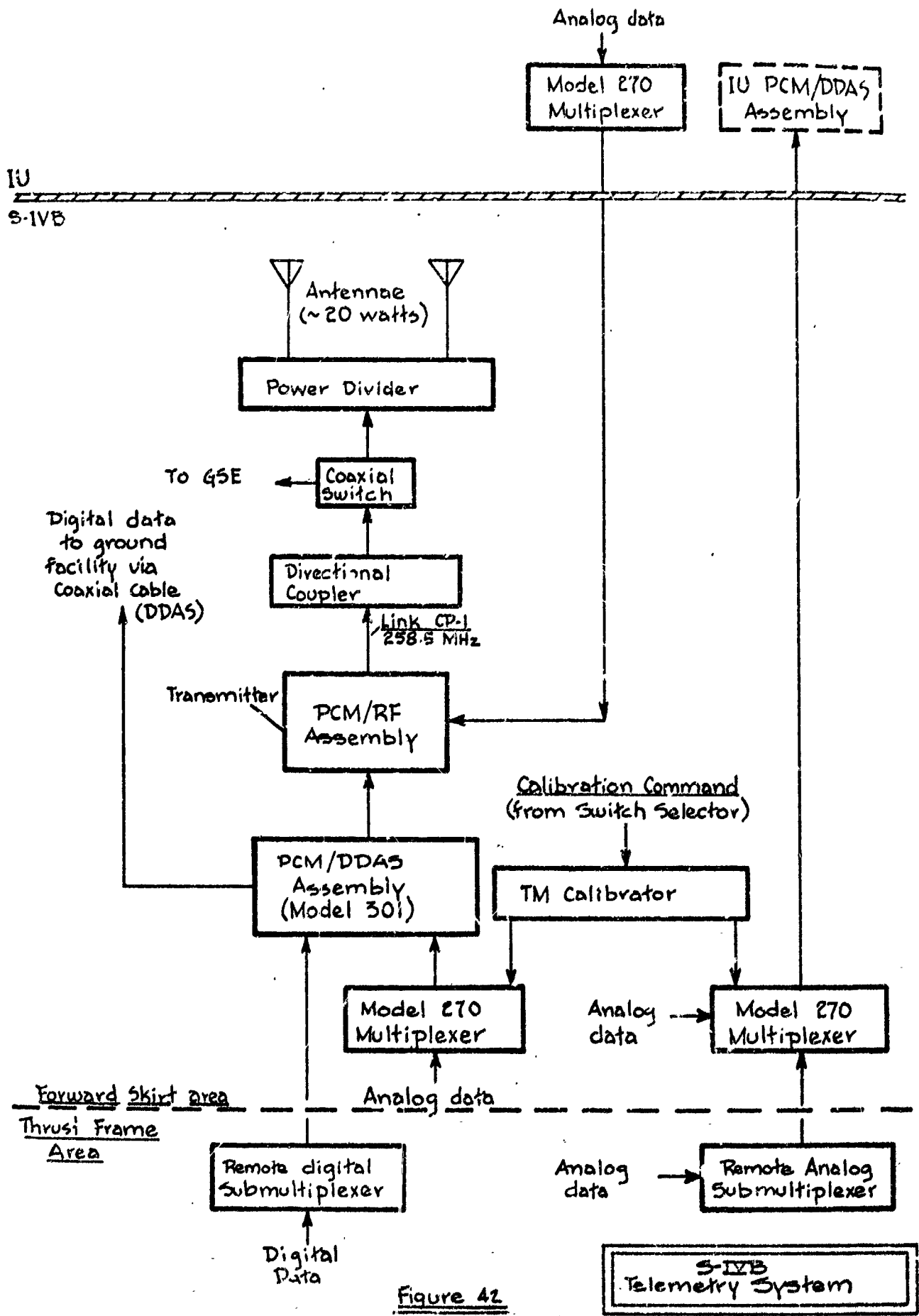

Figure 42

S-IVB Telemetry System

## INSTRUMENT UNIT

The Instrument Unit is a cylindrical structure approximately 260 inches in diameter and 36 inches high which is attached to the forward end of the S-IVB stage. IU structure is composed of an aluminum alloy honeycomb sandwich material which was selected for its high strength-to-weight ratio, acoustical insulation, and thermal conductivity properties.

The cylinder is composed of three 120 degree segments--the access door segment, the flight control computer segment, and the ST-124-M segment.

The IU Stage contains:

Guidance, Navigation and Control Equipment

Telemetry Systems

Tracking Systems

Crew Safety Systems

Environmental Control System

The guidance, navigation and control equipment contained in the IU includes that which is necessary for vehicle guidance and control during boost through orbital coast and subsequently for translunar injection.

Telemetry along with measuring systems is used to monitor certain conditions and events which take place in the IU and to transmit these monitored signals to ground receiving stations.

Tracking systems assist in the determination of the vehicle's trajectory. Tracking data is used for mission control, range safety and post flight evaluation of vehicle performance.

Crew Safety is provided by the Emergency Detection System, a portion of which is located in the IU stage. EDS senses conditions in the vehicle during boost phase which could cause vehicle failure.

Environmental Control maintains an acceptable operating environment during preflight and flight operations.

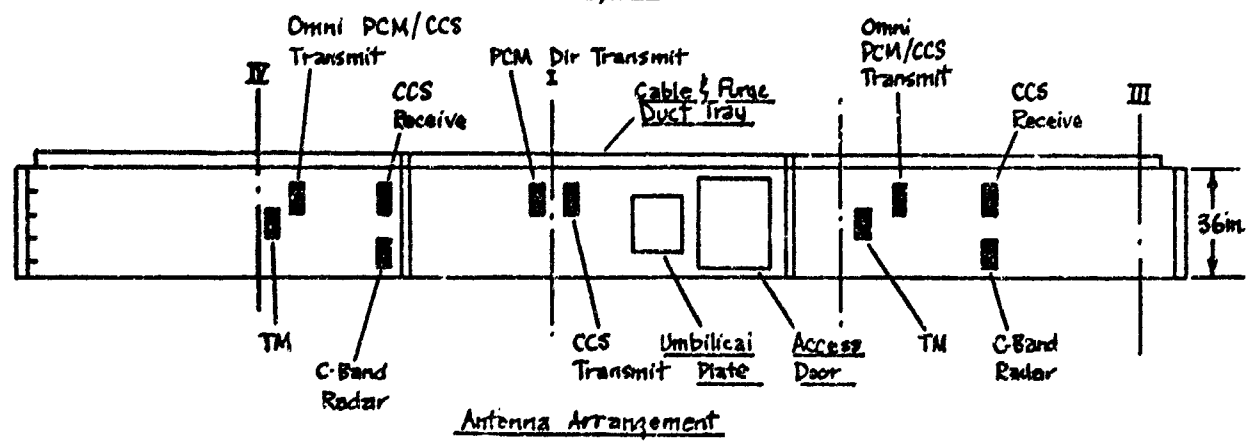
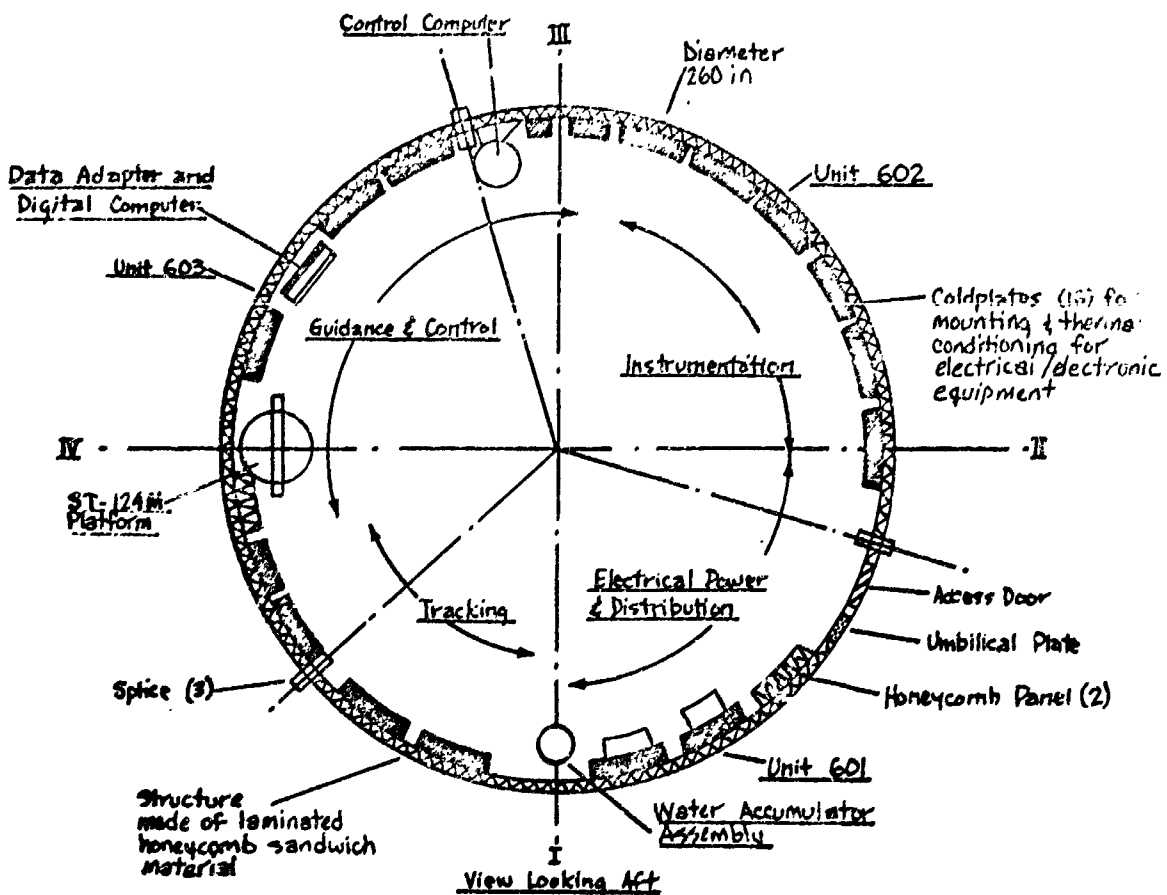

**Weight:**  
 • Dry ~ 4,000 lbs.  
 • Serviced ~ 4,300 lbs.

Instrument Unit Configuration

Figure 4.3

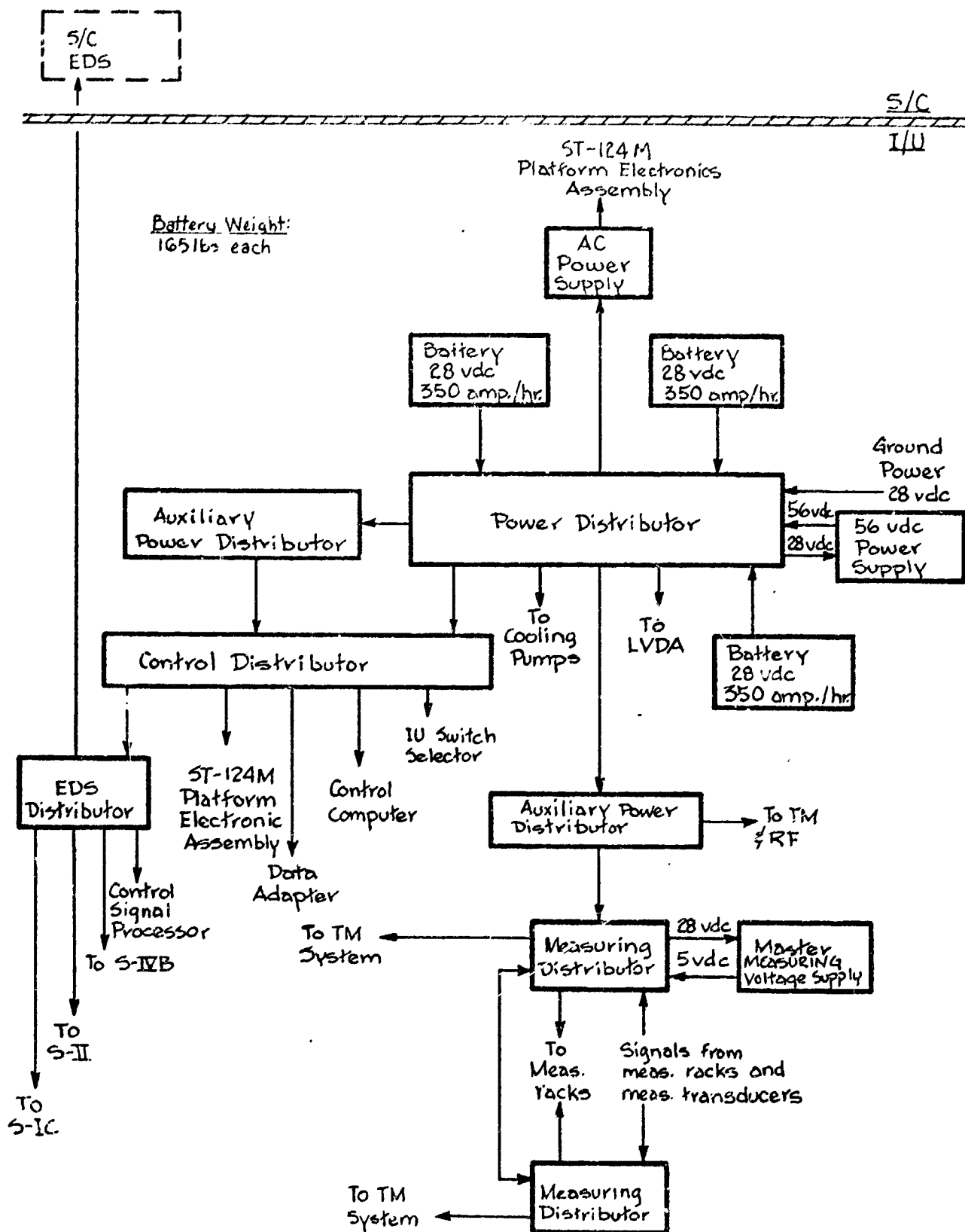
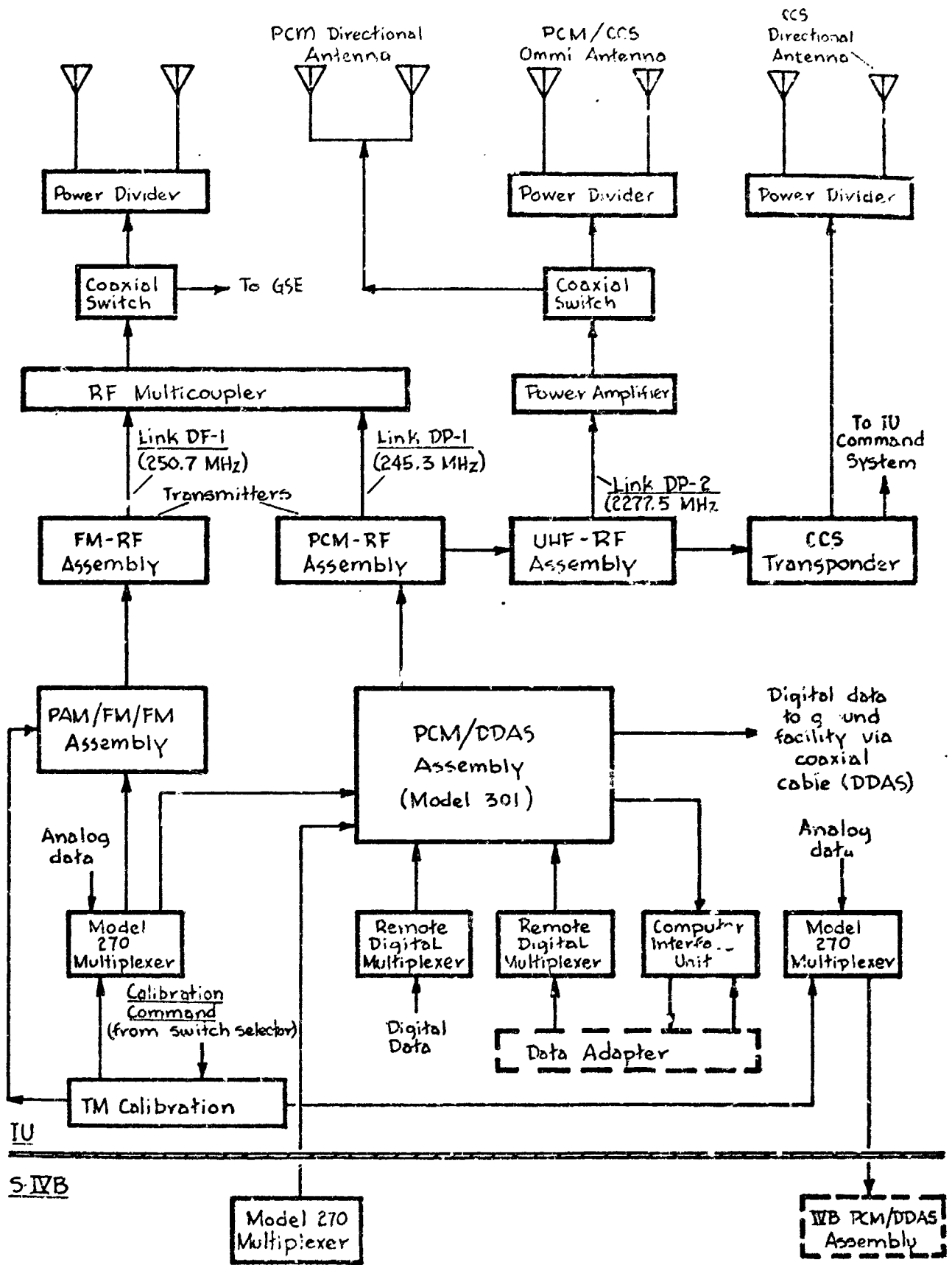

Figure 44

IU Electrical Power & Distribution System



CCS - Command Communication System

Figure 45

IU Telemetry System



## ENVIRONMENTAL CONTROL SYSTEM (ECS)

The Environmental Control System (ECS) has been developed to maintain an acceptable operating environment for the IU/S-IVB equipment during preflight and anflight operations.

The ECS is made up of the following:

Thermal Conditioning System - maintains a circulating Methanol Water coolant temperature of approximately  $59^{\circ} \pm 1^{\circ}\text{F}$ .

Preflight Purging System - maintains a supply of temperature and pressure regulated air/ $\text{GN}_2$  in the IU/S-IVB equipment.

Gas Bearing Supply System - furnishes  $\text{GN}_2$  to the ST-124-M3 inertial platform gas bearings.

Hazardous Gas Detection System - monitors the IU/S-IVB forward inter-stage area for the presence of hazardous vapors.

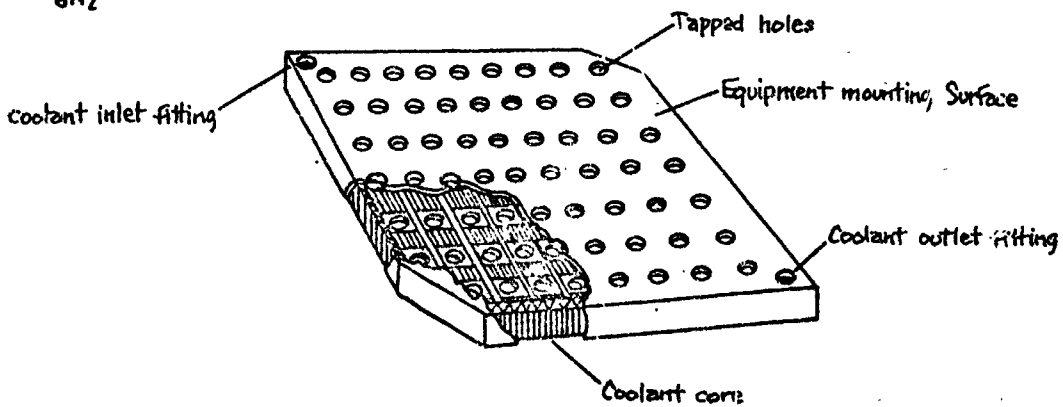
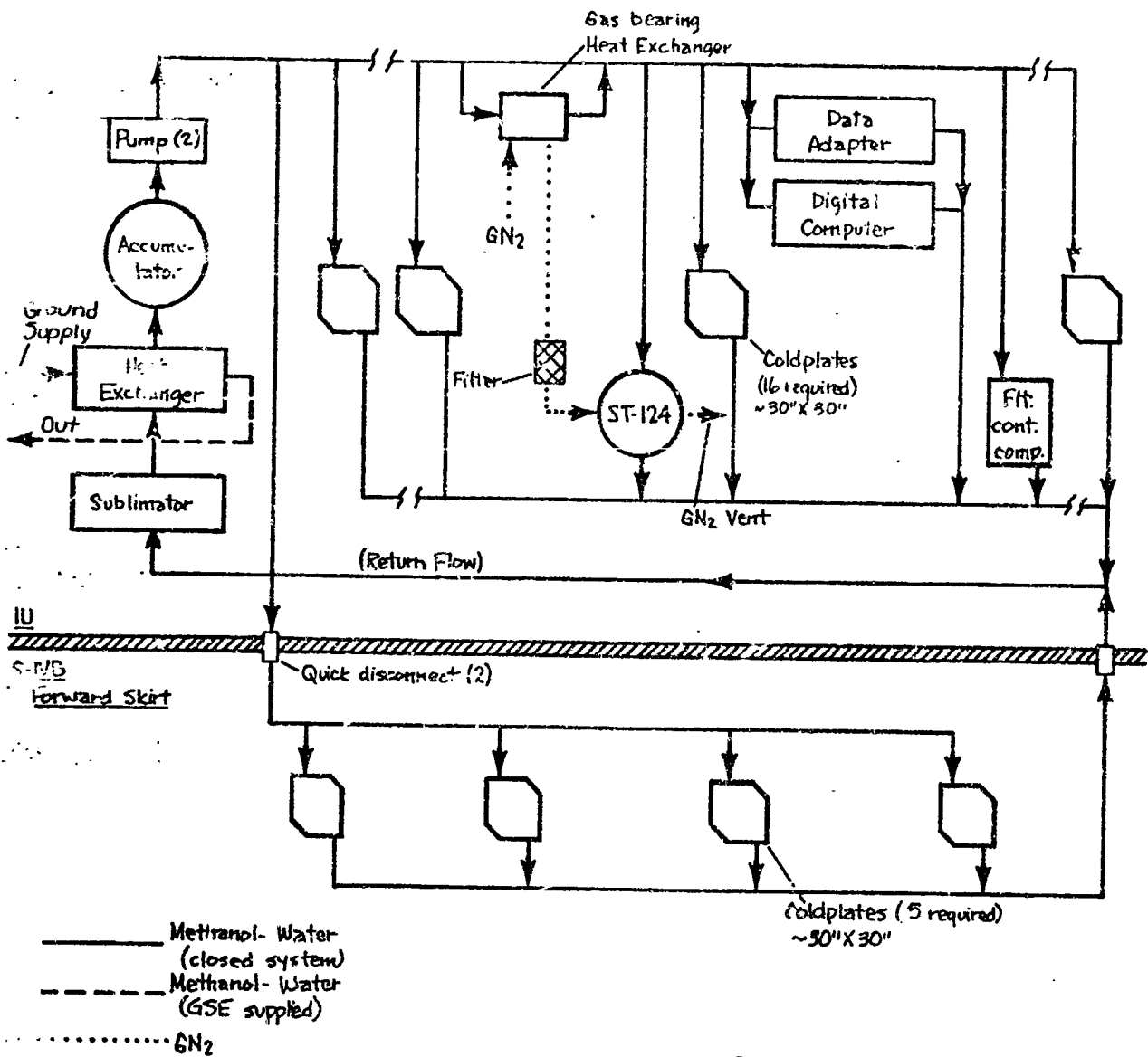

Typical Coldplate

Figure 46

IU/S-IVB Environmental Control System

## SPACECRAFT DESCRIPTION

The Spacecraft for the AS-306 mission is composed of:

Launch Escape System (LES)  
Command Module (CM)  
Service Module (SM)  
Lunar Module (LM)  
Spacecraft Lunar Module Adapter (SLA)

### Launch Escape System

The Launch Escape System, which is jettisoned approximately 35 seconds after S-II Ignition, is made up of a Launch Escape Tower (LET), and a three-motor propulsion system (Tower Jettison, Launch Escape and Pitch Control Motors).

### Command Module

The Command Module is a Block II Configuration. The module's inner structure, or pressure vessel, is separated from the outer structure by a layer of insulation. A heat shield structure is made up in three segments consisting of a forward heat shield, a crew compartment heat shield, and an aft shield. The CM is slightly over 11 feet in length and is about 12 feet in diameter. A propulsion system consists of Reaction Control Engines which may operate pulsed or continuous.

### Service Module

The Service Module may be described as a cylindrical, aluminum shell which is made up of honeycomb-sandwich panels and a forward and aft bulkhead. One gimbaled propulsion engine (capable of up to 30 restarts) and a reaction control system (4 clusters, 4 chambers each) make up the SM Propulsion System. The Command and Service Module are joined by three tension ties each of which is equipped with explosive charges for SM/CM separation.

### Lunar Module

The Lunar Module consists primarily of an Ascent and Descent Stage. The Ascent Stage, which contains the crew compartment, is equipped with a Reaction Control System which provides thrust capability, an ingress and egress hatch to the crew's instrumentation and controls. The Descent Stage, consists primarily of a descent engine and four retractable landing gear assemblies. Over all weight of the Lunar Module is approximately 30,000 pounds.

### Spacecraft Lunar Module Adapter

The Spacecraft Lunar Module Adapter (SLA) joins the Service Module (SM) to the S-IVB/IU. The SLA encloses the Lunar Module. Adapter panels which enclose the Lunar Module are jettisoned prior to docking and Lunar Module extraction.

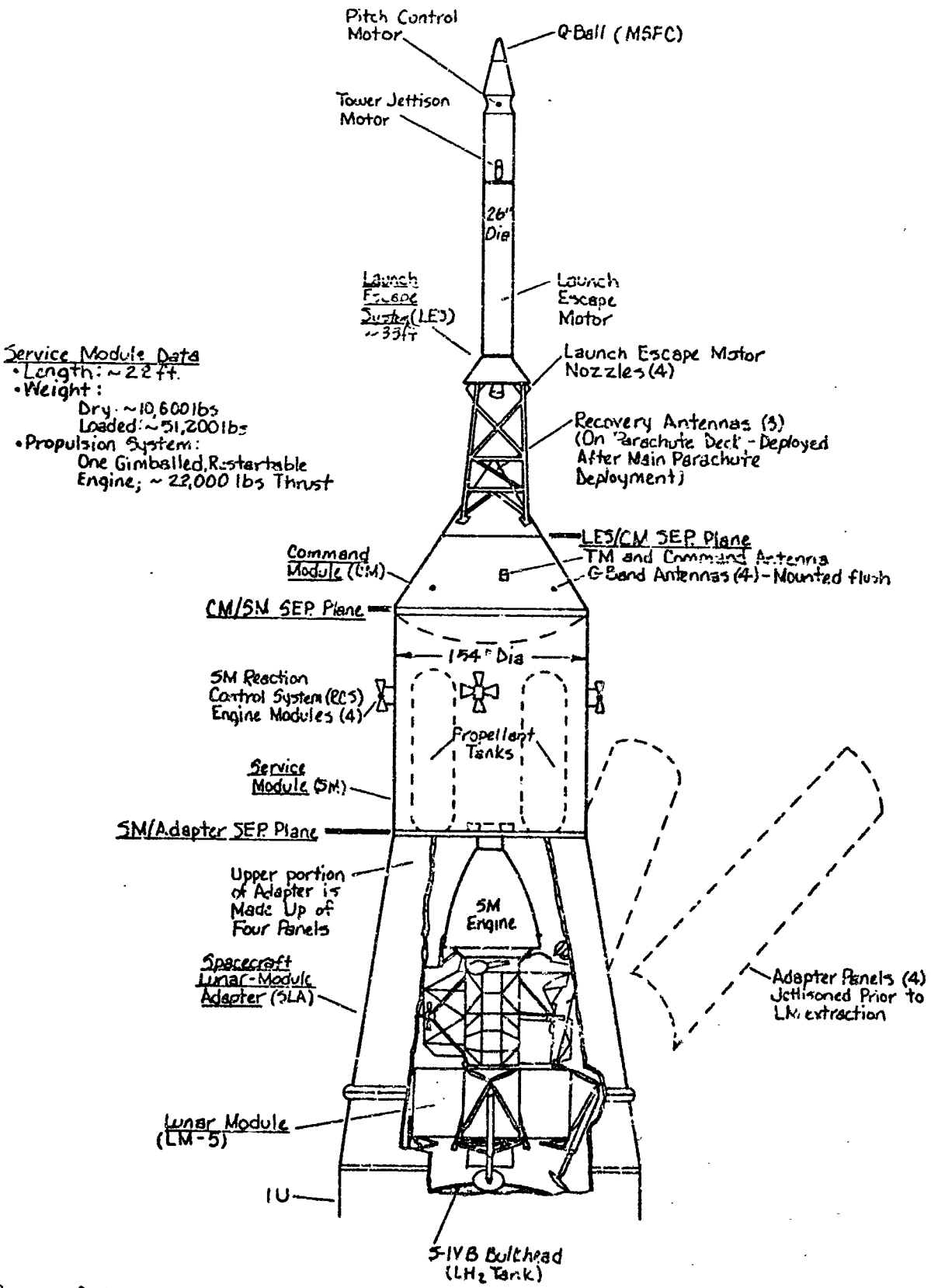

Service Module Data  
 • Length: ~22 ft.  
 • Weight:  
 Dry: ~10,600 lbs  
 Loaded: ~51,200 lbs  
 • Propulsion System:  
 One Gimbaled, Restartable  
 Engine; ~22,000 lbs Thrust

Spacecraft Data  
 • Length: ~81.5 ft  
 • Weight:  
 At L.O. ~100,800 lbs (Less LET)  
 LET ~ 8,900 lbs

Figure 47

Spacecraft CSM 107  
 Configuration

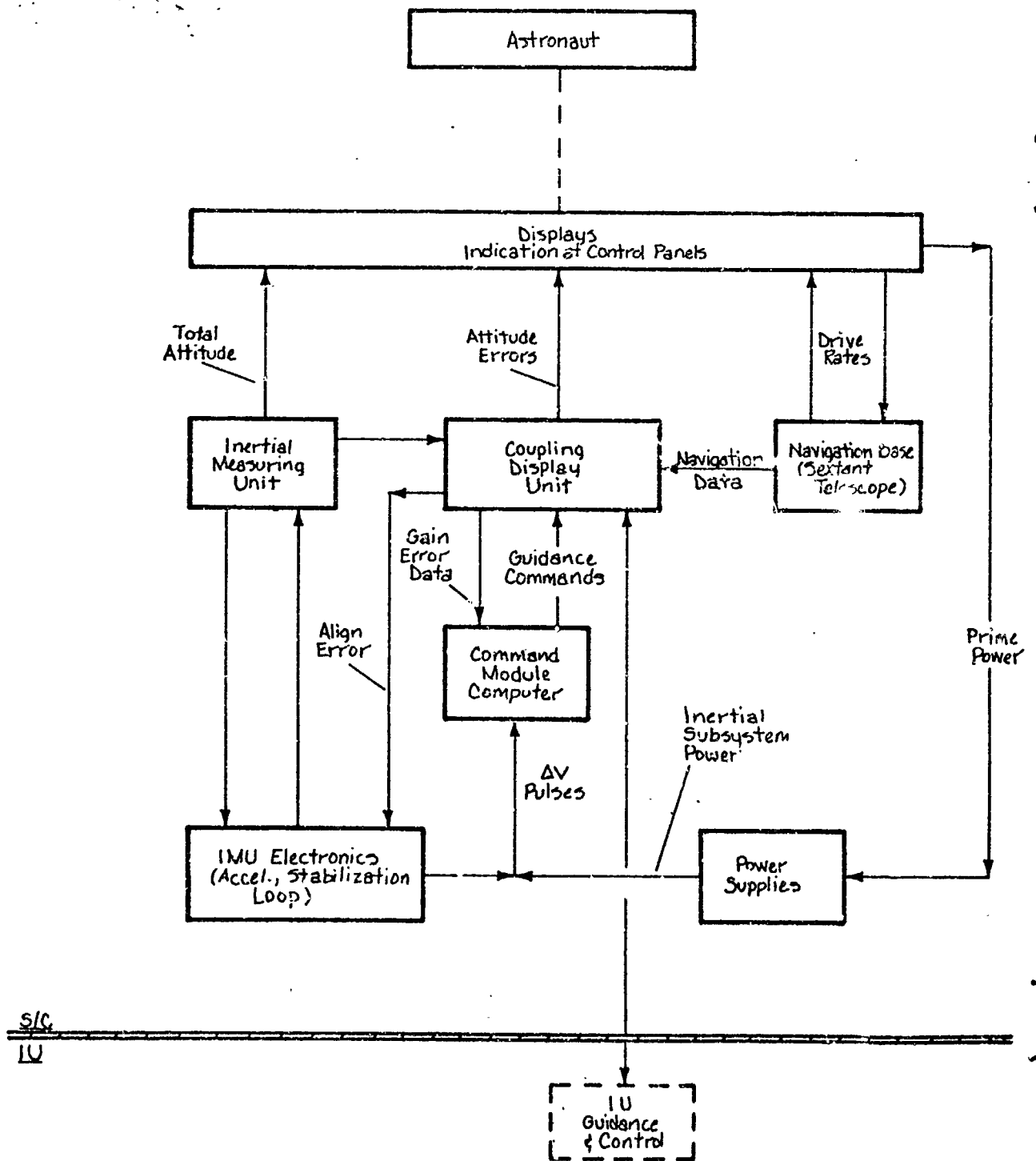

Spacecraft Guidance & Navigation System

Figure 4B

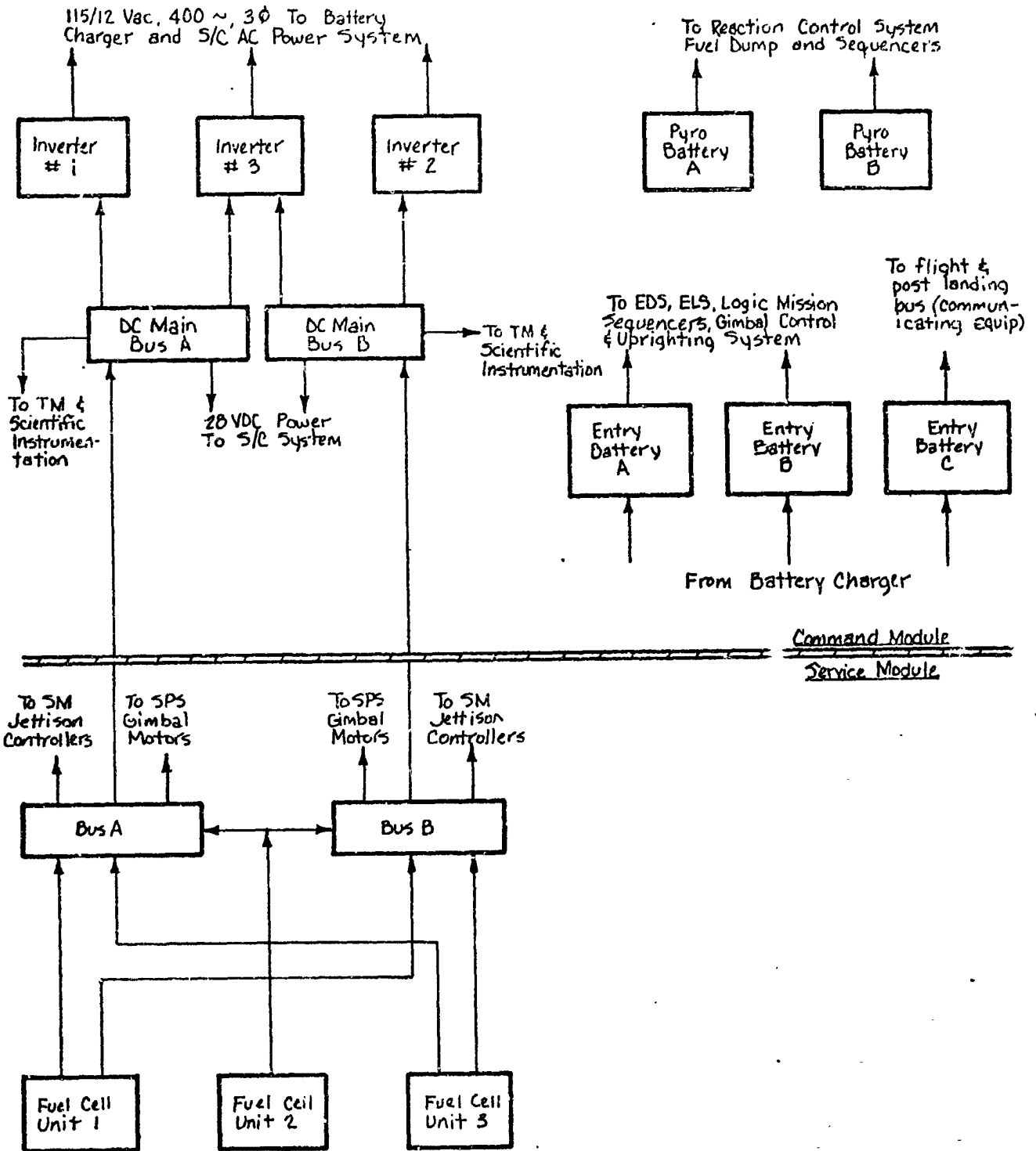
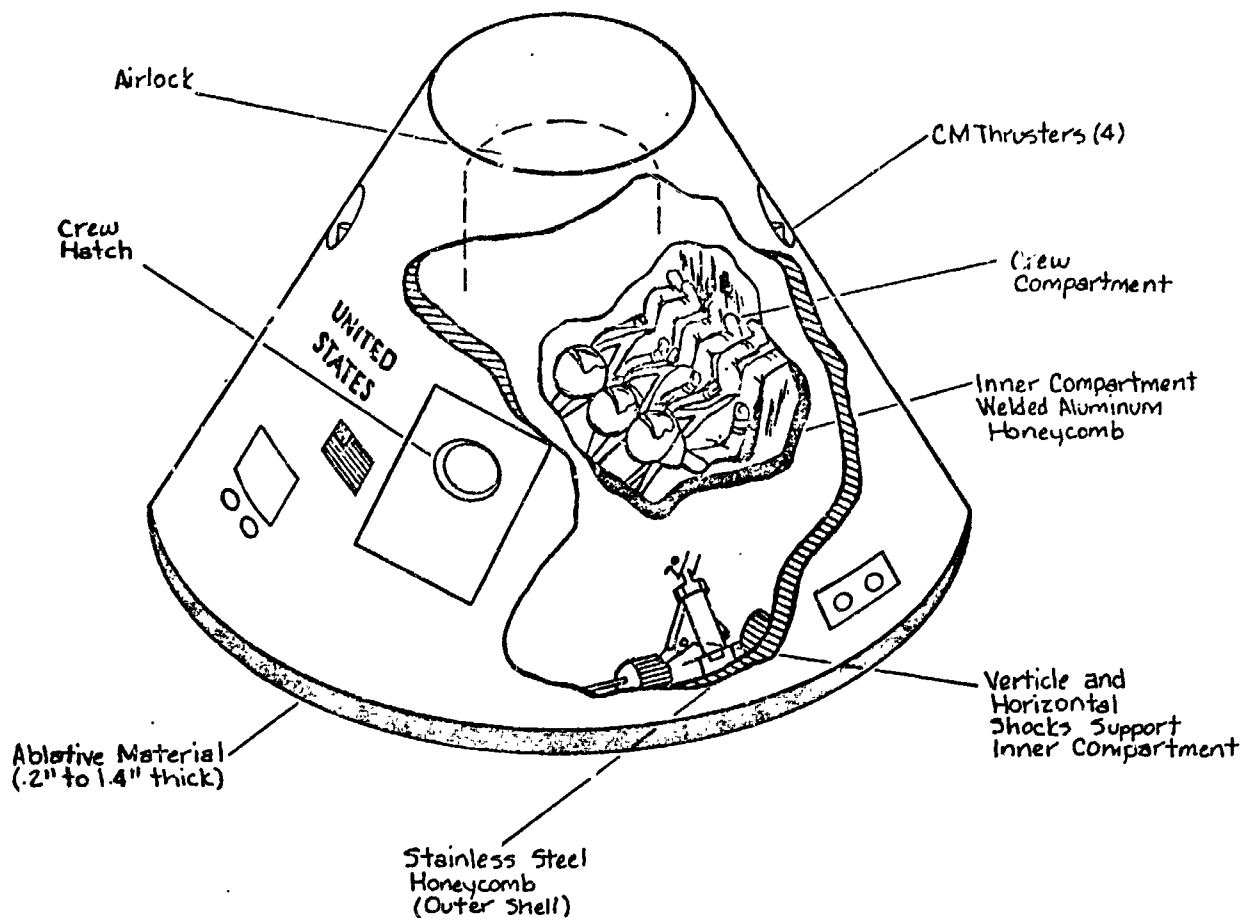

Figure 49

Spacecraft Electrical Power & Distribution System



Type: Block II (manned)

Dimensions: ~ 11 ft in length  
~ 12 ft in diameter

Weights:  
at CM/SM Sep. ~ 13,000 lbs  
at reentry ~ 12,000 lbs  
at splashdown ~ 11,000 lbs

Propulsion System:  
12 Reaction Control Motors  
~ 100 lbs Thrust each

Figure 50

Command Module

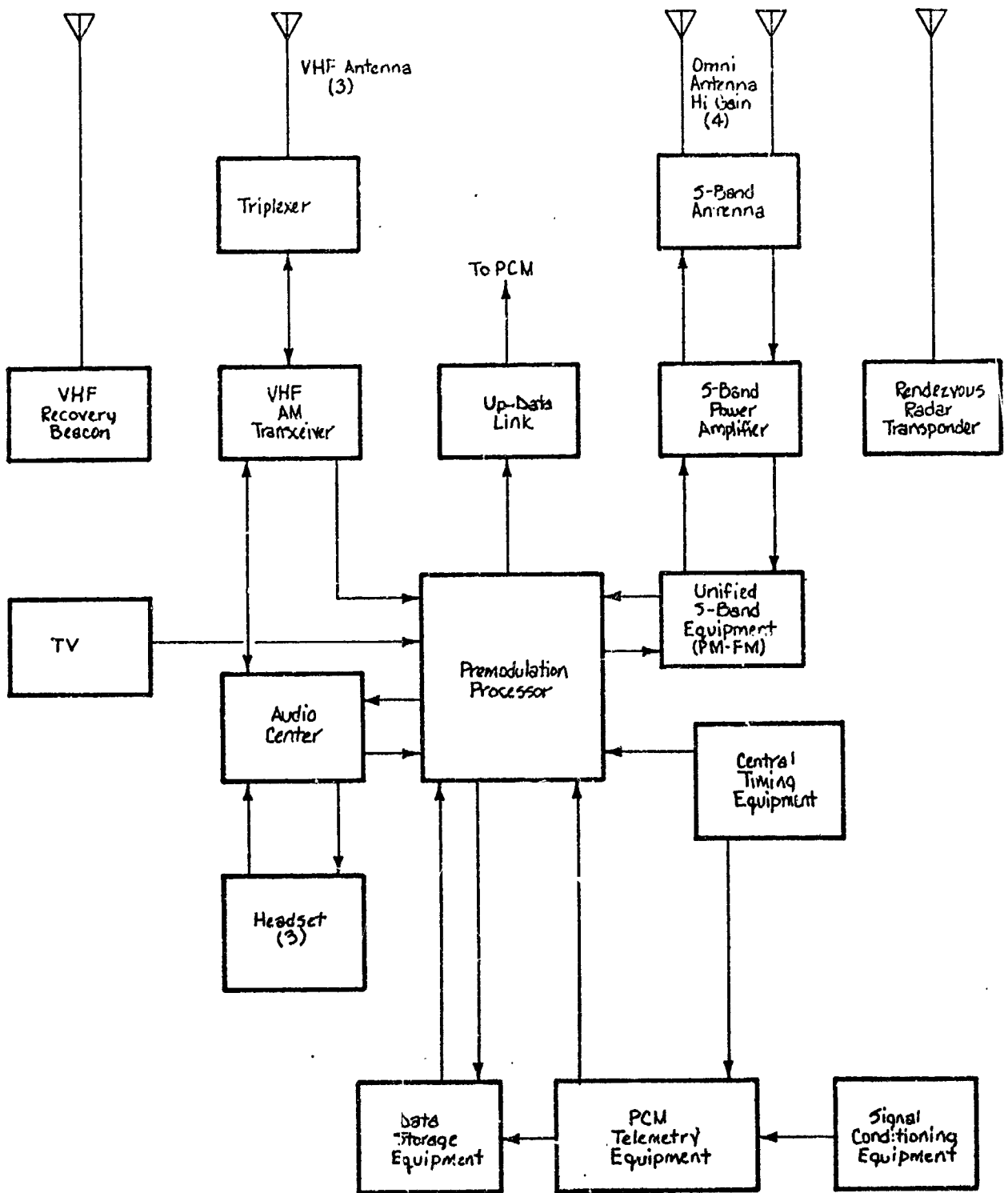

CM Telecommunication System

Figure 51



REPRODUCIBILITY OF THE ORIGINAL PAGE IS POOR.

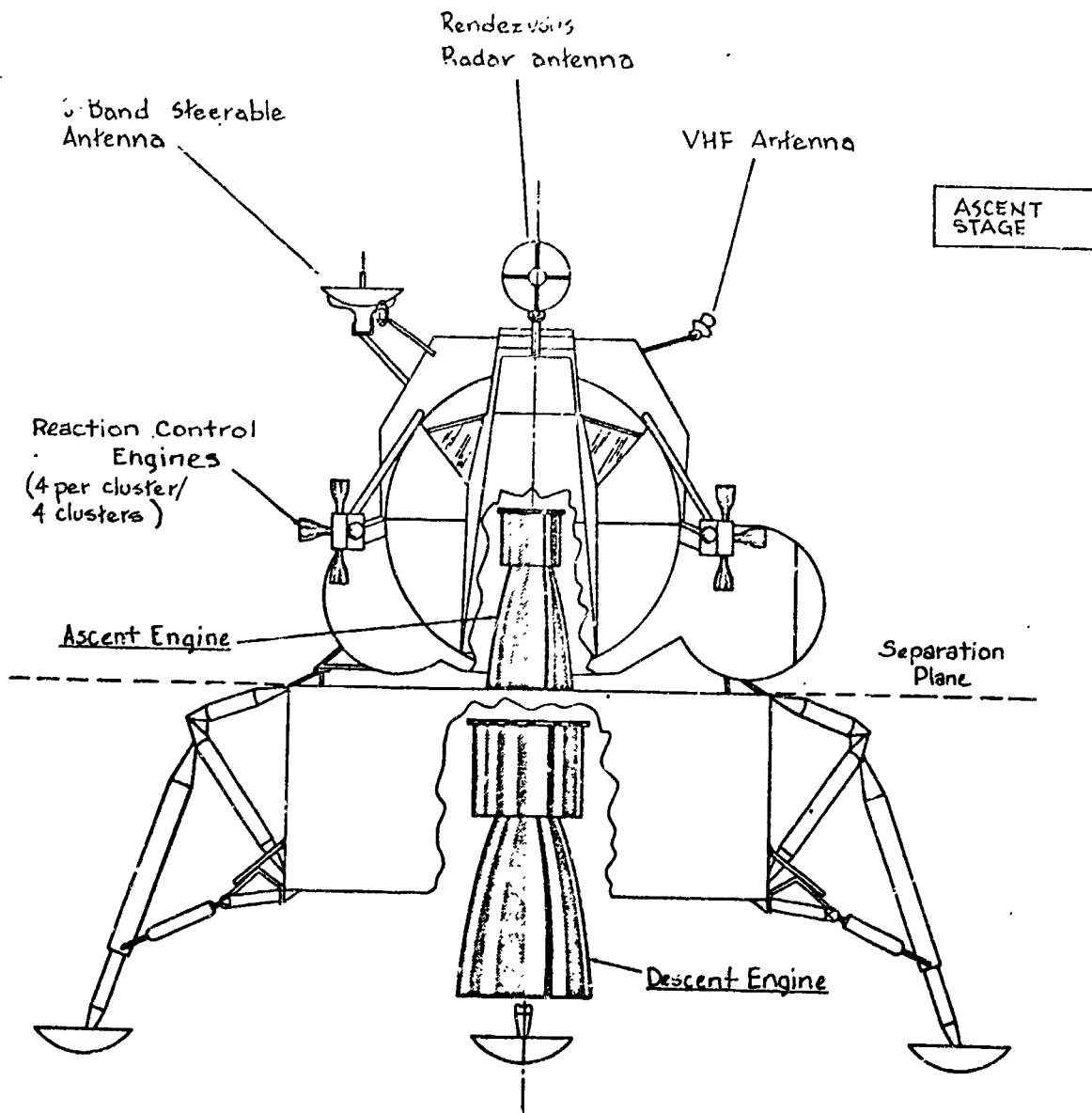

- Weight ~ 33,300 lbs.
- Envelope dimensions:
  - Height ~ 250 in
  - Width ~ 350 in (legs extended)
- Diameter ~ 177 in (Ascent Stage Main Body)
- Propulsion System:
  - 1 Descent Engine  
Throttle controlled thrust  
from 1000 to 10,500 lbs.
  - 1 Ascent Engine  
3500 lbs. thrust
  - Reaction controlled motors  
(4 clusters/4 chambers each)  
~100 lbs thrust each motor.

Figure 52

Lunar Module

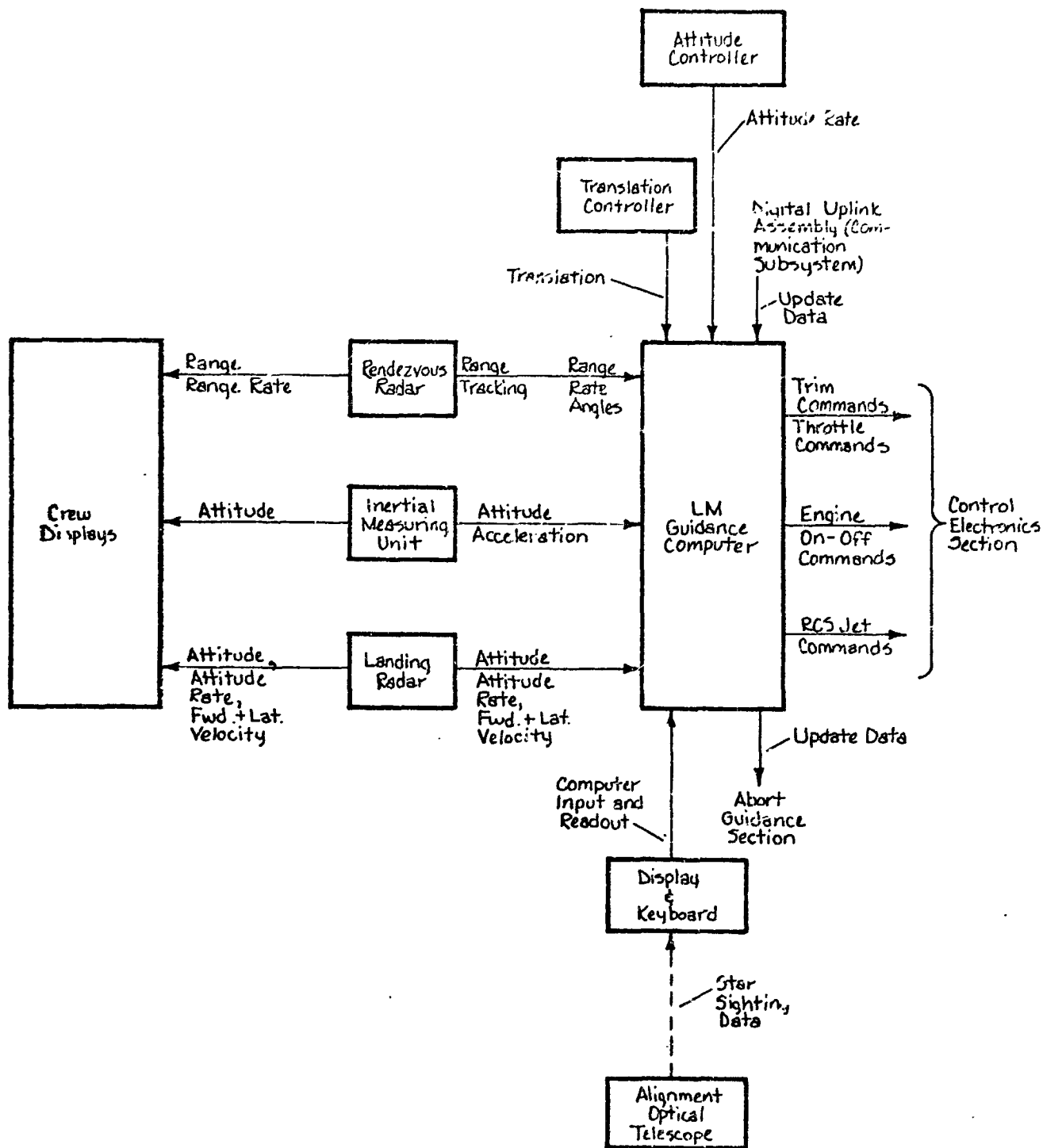

LM Guidance and Navigation System

Figure 53

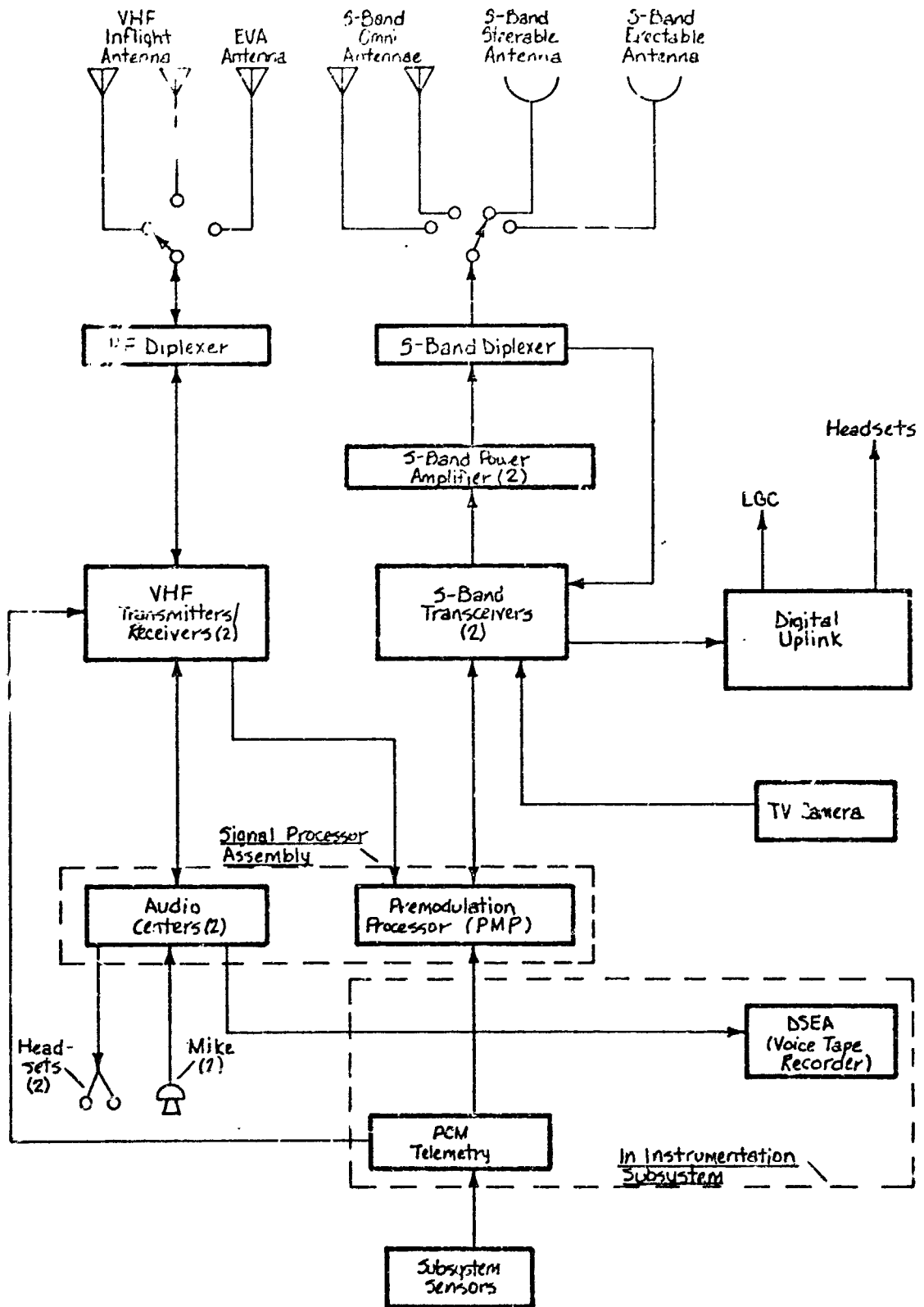

LM Communications Subsystem

Figure 54

REPRODUCIBILITY OF THE ORIGINAL PAGE IS POOR.

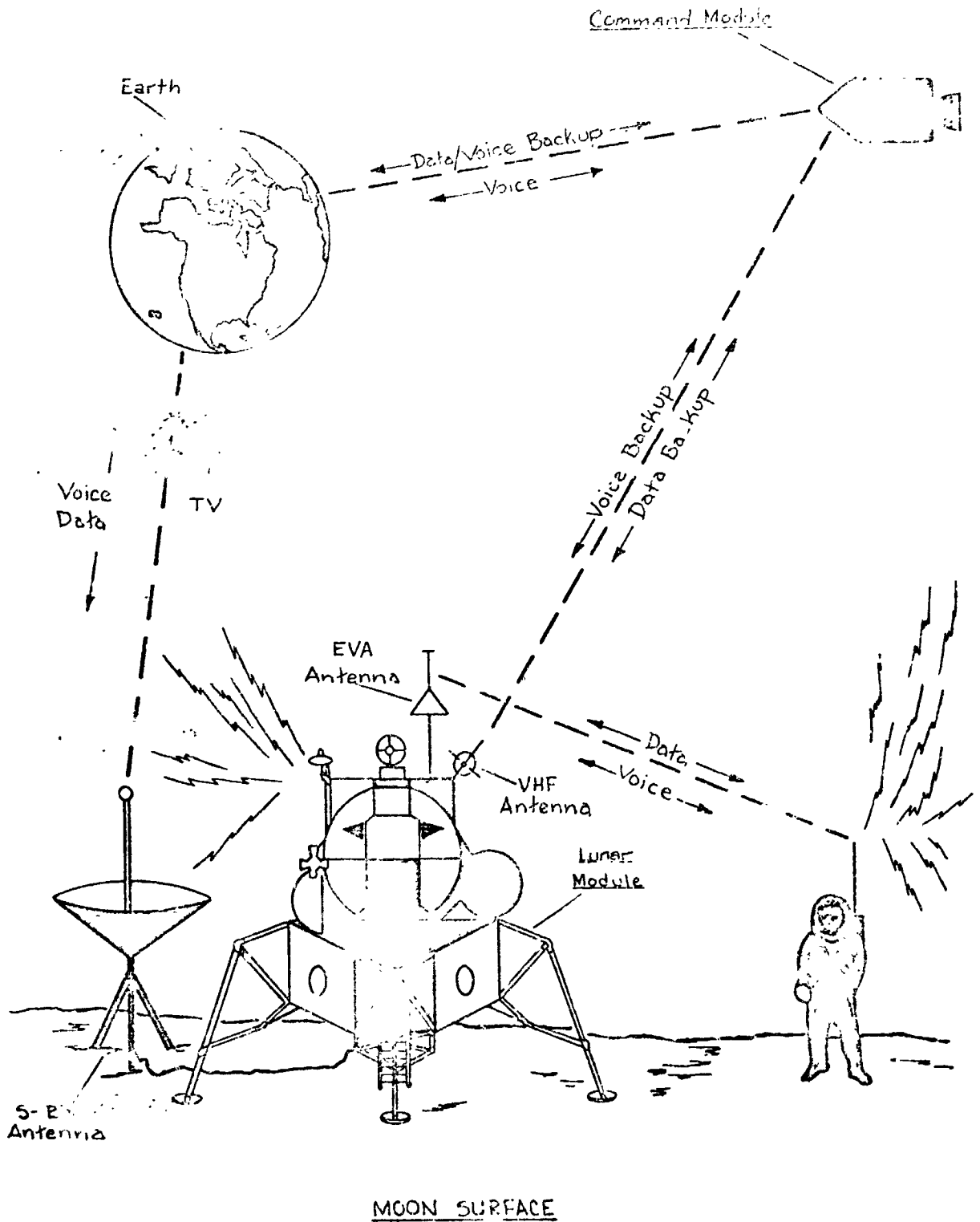

EVA (Extra Vehicular Activity) will consist of:

- Lunar Walk  
(First one then both crew members)
- collect soil and rock samples
- set up experiments for use after departure

Figure 55

LUNAR SURFACE  
COMMUNICATIONS