

ALL ABOUT FREQUENCY MODULATION

Selected Articles Affording
A Comprehensive Insight to
The New Art of F. M. Radio



COMPILED
BY THE EDITORS OF



RADCRAFT PUBLICATIONS, Inc.
PUBLISHERS

20 VESEY STREET

NEW YORK, N. Y.

Copyright 1941 by Hugo Gernsback

Printed in U.S.A.

Contents

| CHAPTER 1 | | Page |
|-----------|--|------|
| | THE ABC OF F. M. | |
| | Frequency vs. Amplitude Modulation..... | 3 |
| | Basic Facts About F. M. Broadcasting..... | 8 |
| CHAPTER 2 | | |
| | CONSTRUCTION | |
| | Build This Practical F. M. Adapter..... | 10 |
| CHAPTER 3 | | |
| | AUDIO AMPLIFICATION | |
| | F. M. Audio Amplifier—Part 1..... | 15 |
| | F. M. Audio Amplifier—Part 2..... | 20 |
| | F. M. Audio Amplifier—Part 3..... | 24 |
| CHAPTER 4 | | |
| | F. M. SERVICE | |
| | Part 1—Antenna Installation and Service..... | 29 |
| | Part 2—Receiver Alignment and Diagnosis..... | 38 |
| | Part 3—Test Equipment for F. M. Servicing..... | 44 |
| CHAPTER 5 | | |
| | ENGINEERING | |
| | Part 1—The How and Why of F. M..... | 47 |
| | Part 2—The How and Why of F. M..... | 51 |
| | Theory and Design Considerations of R. F. and I. F. Coils In F. M. Receivers..... | 55 |

CHAPTER I

THE A-B-C OF FREQUENCY MODULATION

PART I — FREQUENCY VS. AMPLITUDE MODULATION

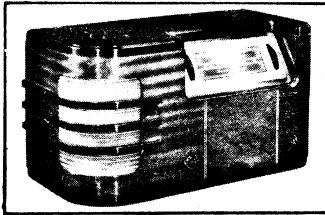

Frequency-modulated receiver.

ONE of the pioneers in radio has again scored an outstanding success. Major Armstrong, who will be remembered as the Father of the superheterodyne type of receiver, has again advanced the art by developing a new type of transmission and reception which bids fair to far out-

strip, in scientific importance, all previous developments.

For years the Major worked to perfect methods and means of eliminating or reducing static and other radio interference — probably the foremost problem confronting the radio industry. After trying various methods of attacking the problem, he had practically given up the idea as he and his associates could see no practical answer.

Over 10 years ago he started a new line of attack which eventually led into a system known as the *wide-band* frequency modulation system which reduced all sorts of disturbances to a very small percentage of their original value. This was accomplished by transmitting a signal having such characteristics that it could not be reproduced by either natural or man-made static; and designing a receiver which was not responsive to ordinary types of modulated waves but only responsive to waves having the special characteristic.

Thus this type of transmission and reception emerges from the laboratory and bids fair to revolutionize the transmission of intelligence.

It is the purpose of this article to explain what frequency modulation is, how it operates, and the advantages which it presents as compared to amplitude-modulated systems.

"A.M." AND "F.M."

A concept of *amplitude modulation* (or "A.M.") may be obtained from the diagram of a high-frequency alternating voltage which changes its amplitude with time, as shown in Fig. 1. This is the type of modulated carrier transmitted by present-day methods. Figure 2 shows a carrier frequency, the frequency of which is changing at some definite rate. This is the type of signal which is transmitted by a *frequency-modulated* (or "F.M.") station. Now let us examine tuned circuits and see how amplitude and frequency modulation can actually be effected.

"A.M."—Assume that the tuned circuit shown in Fig. 3 is continually supplied with energy so that the alternating current set up therein has the same amplitude at all times. Let us insert in this tuned circuit a microphone which has the property of varying its resistance according to the amplitude of sound waves impinging on the diaphragm. It is well known that if the resistance of a tuned circuit varies, the amplitude of the current flowing in the tuned circuit varies accordingly. Consequently, sound waves striking the diaphragm of the microphone would cause a current to flow in the tuned circuit such as that shown in Fig. 1.

"F.M."—An idea of the method in which a frequency-modulated signal could be produced may be had from the same tuned circuit and again assuming that energy is being supplied to this tuned circuit so that the amplitude of the current is at all times constant.

Now let us connect across the tuned circuit a condenser type of microphone which consists essentially of 2 thin metallic plates, the positions of which vary in respect to each other in accordance with the sound waves striking the microphone. As this microphone does not change its resistance appreciably, a sound wave impinging on the microphone would simply vary the frequency of the tuned circuit because the total capacity of the tuned circuit would be altered and its frequency is dependent upon the capacity. This circuit is shown in Fig. 4. Sound waves thus may be made to vary the carrier frequency such as shown in Fig. 2.

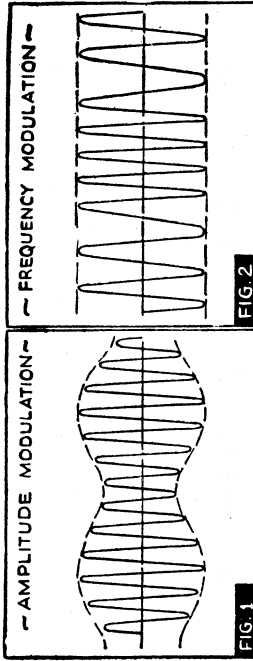

FIG 1

FIG 2

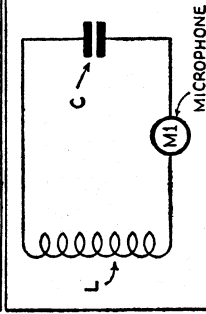

FIG 3

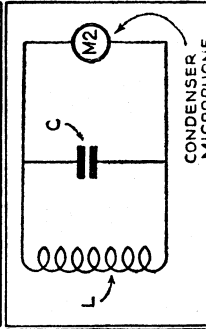

FIG 4

At 1 and 3 are shown, respectively, a representative waveform of an amplitude modulated signal, and the manner in which it may be produced. An equivalent arrangement for frequency modulation is shown at 2 and 4. In 3, microphone M1 varies its resistance according to the amplitude of sound waves; at 4, condenser-type microphone M2 varies its capacity as the sound waves strike the diaphragm.

In the foregoing analysis only theoretical arrangements have been considered both for the amplitude-modulation and frequency-modulation methods. In practice, of course, more complicated arrangements must be employed to effect either type of modulation to give a commercially useful result.

STATIC FREE

A simple explanation of why the system is so free from static and other disturbances lies in the fact that these disturbances, while they have very great amplitude-modulation changes have relatively small frequency changes. Hence by designing a receiver for frequency modulation which does not respond to amplitude changes and which only responds well

ALL ABOUT FREQUENCY MODULATION

to large frequency changes practical immunity from interference can be obtained.

Then by designing a transmitter which sends out a widely swinging frequency modulated wave a full response can be obtained in the receiver. The differentiation between noise and signal resides mostly in this special characteristic.

Estimates on the effectiveness of elimination of static due to lightning, etc., vary from 96% to about 99%. It is certainly true that frequency modulation signals can be heard right through a local thunderstorm while amplitude modulation

signals are entirely blotted out due to noise.

RECEIVER REQUIREMENT

Limiter.—As frequency modulation is considerably different from the standpoint of its transmission, it is only natural that the receiver picking up frequency modulation signals is materially different in its design.

Fundamentally, the receiver has an R.F. amplifier system which should pass a broad band of frequency as will be evident from future considerations. It then has a wide-band I.F. amplifier in which is incorporated a "limiter circuit," the function of which is to keep the amplitude of the amplified signal constant at all times. This limiter might be likened to a very rapidly-acting automatic volume control system.

Detector.—The detecting system for frequency-modulated signals varies materially from the conventional type. This will be appreciated by careful analysis of the method of transmission. If we go back to Fig. 4 and consider sound waves impinging on the condenser microphone it is readily apparent that the amount the condenser plates of the microphone move is in general proportional to the loudness of the sound waves and consequently the amount of variation of the carrier frequency is proportional to the

intensity of the sound waves. The number of fluctuations per second which the diaphragm executes is obviously the same as the frequency of the audio note impinging on it. This means that the frequency of the carrier will swing back and forth over its range a number of times per second which is the same as the audio frequency being transmitted. Thus the detecting system must be capable of producing audio voltages whose frequencies are proportional to the rate of frequency change of the received R.F. signal; and whose magnitudes are proportional to the amount of frequency change.

There are several types of limiter and detecting circuits which may be utilized, but probably the simplest and most effective is a limiter circuit consisting of a sharp cut-off tube and a resistor in series with the grid of this tube developing a negative bias which is applied to other I.F. amplifier tubes.

For the detecting system, an I.F. transformer somewhat similar to that used for the discriminator of an automatic-frequency-controlled receiver may be readily employed, for the circuit is so arranged that if the intermediate frequency varies, a voltage is developed across a resistor in the cathode circuits of a 6H6 rectifier tube.

The limiter and detecting systems are shown schematically in Fig. 5. It might be pointed out in passing that the adjustment of the I.F. transformer feeding the 6H6 is quite critical if good quality reception is to be obtained.

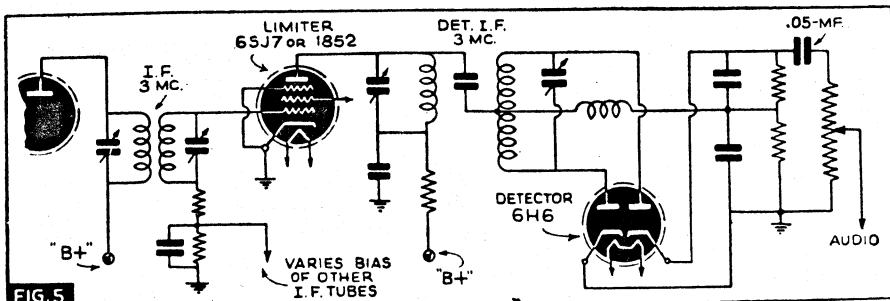

Detailed diagram showing the manner in which the "limiter" is connected to prevent amplitude variations being passed on to the detector circuit.

ALL ABOUT FREQUENCY MODULATION

DYNAMIC RANGE; INTERFERENCE

If a large dynamic range is to be had in frequency modulation transmission, the bandwidth necessary may be 100 kc. or more either side of the carrier. Obviously such bandwidths can not be obtained on present broadcast channels and it is necessary for frequency modulation transmission to resort to high frequencies where there is available space in the ether. Most frequency transmissions are thus around 7 meters (between 39 and 44 mc.).

When listening to frequency modulation transmissions, the *dynamic range* is very apparent. That is, the program may go from the lowest (volume) to the loudest passages of an opera with the same clearness and fidelity. Complete absence of interference is also very apparent especially during times of intense static when shortwave amplitude-modulated stations are completely blotted out. There seems to be very little fading. This may not be entirely due to the method of transmission but partly because of the frequency of transmission. Utilizing a well-designed receiver, a few microvolts signal is all that is necessary for good reception.

There can be no interference from one station to another such as encountered in amplitude-modulated signals! If 2 frequency modulation stations some distance apart were to transmit on the same frequency and if a frequency modulation receiver were gradually moved between the 2 stations, either one or the other would be heard. There might be a "no man's land", so to speak, where the program of one station and then the program of the other station would be heard, but there would be no interference as we know it.

It would appear that frequency modulation will, in the years to come, come into its own and in a large measure supersede the present method of shortwave transmission. It certainly has in its favor program enjoyment which can not be obtained by the older methods.

Technicians may wish to refer to one of the following published articles:

- (1) "A Method of Reducing Disturbances in Radio Signaling by a System of Frequency Modulation," Edwin H. Armstrong, *Proc., I.R.E.*, Vol. 24, No. 5, May, 1936.
- (2) "New Ears for Your Radio Set and New Fortunes in Radio," *Ken*, June 29, 1939.
- (3) "Revolution in Radio," *Fortune*, October, 1939.
- (4) "Science Tunes in a New Kind of Static-Free Radio Service," *Science News Letter*, June 10, 1939.

To complete this reference material for Servicemen the following additional information is given.

I.F. ALIGNMENT

Due to the good stability of components and the wide-band characteristics of the I.F. circuits, alignment should be unnecessary under normal operating conditions. Should I.F. alignment become necessary, it will require a cathode-ray oscilloscope and

a 2.1 megacycle signal generator with a superimposed ± 300 kc. sweep frequency.

This generator may be made by constructing an oscillator with the tank condenser semi-fixed and variable, the variable portion being designed to rotate with a motor and of proper capacity to give ± 300 kc. variation of the 2.1 megacycle mid-frequency.

Connect the vertical plates of the oscilloscope across resistor R10 and align transformers L5, L4 and L3 progressively. A 2 mh. choke should be connected in series with the high side of the oscilloscope.

With the same oscillator and sweep signal as used above, connect the vertical oscilloscope plates across resistors R11 and R12. Align transformer L6 for an x-shaped crossover curve. Proper alignment of C13 is indicated when the curve crosses about midway in the vertical plane. Proper alignment of C12 is indicated when the sides of the curve near crossover are nearest to a straight line.

Note: Keep signal input high enough so that noise limiter is functioning. This point is indicated when an increase in signal input no longer changes the size of the curve.

R.F. ALIGNMENT

Make sure the dial pointer coincides with the first division on the low-frequency end of the dial scale when the gang condenser is completely closed.

(1) Connect a 0-50 or 0-100 microamp. meter in series with the low end of R10. A high-resistance, 0-10 V., D.C. voltmeter may be used instead of the microammeter. Connect the voltmeter across R10 with a 2 mhy. choke in series with the high side.

(2) Apply an unmodulated signal in the region of 43 megacycles to the antenna.

(3) Adjust pointer so it is set to the scale mark of the signal used and peak trimmers C36 and C35, in this order, for maximum meter reading.

BASIC FACTS ABOUT F-M BROADCASTING

THE progress of Frequency Modulation ("F.M.") as with anything that is new and not fully understood—has given rise to a number of common fallacies, widely spread by omnipresent pseudo-experts who do not grasp the picture quite so fully as they believe they do.

Many of these fallacies deal with the capabilities and limitations of F.M.; others seek to anticipate public reaction. Most of them are sheer conversation pieces. All of them bear refutation, in light of the remarkable growth that has attended the new noise-free, full-fidelity method of radio broadcasting during recent months.

Here, for example, are a few representative misconceptions about F.M. that have gained erratic circulation.

(1) *F.M. stations can't be heard more than 50 miles from the transmitter. Therefore they can't begin to service as great an area as the regular amplitude stations. It will take many, many more stations to cover as great a territory as that reached by the major standard stations today.*

This is a common example of misinformation. The coverage area of an F.M. station is based on a combination of 3 factors:

(a) The height of the antenna above the surrounding countryside;

(b) The power used at the transmitter; and,

(c) The type of antenna employed.

Service ranges of 100 to 125 miles from the transmitter are quite possible, and many of the applications now pending before the Federal Communications Commission will be for such service areas. The range of an F.M. station is the same by day and night—an unvarying, unfading signal of remarkable clarity. Very few 50,000-watt stations of the ordinary type reach a greater area with consistency during daytime hours. The night-time coverage is greater, of course, but marred by fading, static and cross-interference beyond the primary coverage area.

(2) *F.M. networks are impossible with the use of telephone wires because these wires won't carry the high-fidelity*

notes that F.M. demands for full-natural quality. Therefore the use of radio-relay—small transmitters placed at intervals across the country to carry programs from network station to network station—is the only answer. This would be very expensive and there is no proof that it might be satisfactory for a coast-to-coast hook-up.

Wrong again. Telephone wires can carry the 30-to-15,000 cycle range of tone demanded by F.M. stations. They can carry even much higher ranges. Such telephone lines do not exist widely at present because there is no great demand for them. But the phone companies stand ready to supply this superior service when the demand is strong enough to warrant the installation of such new facilities.

The development of F.M. networks on a nationwide scale, co-operatively run, is expected to start within another year or two. By that time the telephone companies will probably have the new, full-range wires ready for use.

(3) *The public has a "tin ear." The public can't tell a high note from a medium one. Furthermore, the average hearing doesn't register above 10,000 cycles, so why bother with a lot of fancy equipment to bring in notes as high as*

15,000 cycles? "High fidelity" doesn't mean anything, because the average A.M. set today can't reproduce notes above 5,000 cycles anyway.

This let-well-enough-alone attitude is a poor argument. The public has a so-called "tin ear" only in that it has never known what natural, full-fidelity radio can sound like. Experience shows that average listeners, after hearing F.M. for a period of a few days, are acutely aware of a flatness in standard broadcast reception when they return from F.M. to A.M.

The fact that the average hearing does not go above 10,000 cycles is no indication that the ear does not catch and appreciate the many overtones created in this airy region of the sound spectrum. It is here that the illusion of color, depth, extreme naturalness is created. It is further heightened by

ALL ABOUT FREQUENCY MODULATION

the fact that F.M. has no "carrier noise." There is no rushing sound when voices or music are not present on the wave, as in standard broadcasting. F.M. is completely silent. The faintest innuendoes of tone are not muffled in this everpresent background rush.

(4) *It's proof, say the F.M. scoffers, that the public doesn't want or appreciate high-fidelity, since surveys show so many listeners leave their tone controls on the "bass" position. This cuts out the treble notes that occur up around 8,000 cycles and above.*

Actually it proves nothing of the kind. It merely shows that the average listener is instinctively aware of the background rush in amplitude or "A.M." broadcasting which becomes definitely prominent with the tone control at "treble." By reducing the tone control to "bass" all the highs, badly distorted through the rushing background, are eliminated and the listener has a nearer (albeit lopsided) approximation of the real, natural thing. True "high-fidelity" does not place any emphasis on either bass or treble. High-fidelity reproduces precisely what the microphone hears, with the same proportion of highs and lows.

(5) *Why buy a new F.M. receiver when all the best programs are still on the regular stations? How can anyone expect the average radio listener to have 2 complete receivers in his living room? There are 45,000,000 receivers in this country. Why should they become obsolete overnight?*

Nobody wants them to. There are now companies manufacturing the new F.M. receivers for marketing during the next few months. But—in almost every case—the new F.M. sets also have a band-switch that can turn instantly to standard broadcasts, thus giving you a choice of the old or the new.

In addition, a number of manufacturers are making "adaptors" or "translators" that may be used in conjunction with a standard set to receive F.M. programs. Their use, however, is only recommended with sets that have superior tone—since the F.M. full-fidelity qualities may be easily destroyed by a poor loudspeaker.

America's 45,000,000 radio sets will not be obsolesced overnight. As the public buys new sets, it will be urged to purchase combination A.M.-F.M. receivers. The process

therefore will be one of normal absorption over a period of years.

(6) *F.M. is quite beyond the range of the average pocketbook. F.M. sets will always be much more expensive than the regular type of receiver.*

F.M. sets today are not produced in mass quantities. Consequently their "per unit" cost is greater. Basically there is no important difference between the components used in an F.M. receiver and those of a standard receiver, except that F.M. demands a better loudspeaker and better-quality parts in the audio-frequency section of the set.

F.M. receivers today start at \$70, run up as high as you care to pay for a fancy cabinet and allied gadgets (such as phonograph, automatic record-changer, short-wave bands, etc.). The new adaptors will sell for less than \$50. As the public purchases larger numbers of F.M. sets, the price will naturally tend to decrease.

(7) *Even if you do purchase an F.M. receiver, there are no programs of interest on the air. Most of the F.M. stations will just relay programs of regular stations so that, from an entertainment angle, there's not much sense in getting an F.M. receiver.*

On January 1, 1941 the new F.M. broadcast band will be opened to full F.M. commercial operation on a par with standard broadcasting.

The new F.M. stations realize strongly that they must provide a different program schedule, to a good degree, from that heard over the regular stations. Many of them are already offering a daily schedule that duplicates only the most popular and important broadcasts. The new regulations issued by the Federal Communications Commission require a minimum of 6 hours' operation daily—3 in daylight hours, 3 at night—with at least 1 hour in each period devoted to special F.M. programming. Almost all of the new stations, however, will operate much longer than 6 hours daily, originate far more than merely 2 hours of F.M. shows a day.

Many of the new stations will have no connection with existing broadcasters; their programs, therefore, will naturally have to be special originations. Purchase of a combination F.M.-A.M. receiver is tantamount to opening up a whole new world of radio listening enjoyment . . .

CHAPTER II

CONSTRUCTION

BUILD THIS PRACTICAL F.M. ADAPTER

Complete directions make it easy for any constructor to build and align this Frequency Modulation Adapter.

WITH the advent of Summer, the value of programs over the new frequency-modulated broadcasting stations will become more and more apparent. Our own investigation of this new field bears out the statements which have been made by the engineers of several of the large companies which now have frequency modulation receivers and frequency modulation adapters for use with regular broadcast receivers available.

The claim, of course, which seems most important with Summer and the thunderstorm season coming on, is that frequency-modulated broadcasts can be received through the most severe thunderstorm with no interference whatever.

Here's an interesting story that illustrates this feature, which Frank Gunther, the Chief Engineer of Radio Engineering Laboratories, the organization which has built most of the equipment for Major Armstrong, as well as for many other frequency modulation broadcast stations, told us that one day last Summer.

When a crowd of visitors had climbed the mountain to the location of the Yankee Network's station at Paxton, Mass., a very severe lightning storm came up. The children of the group were obviously frightened. The engineer in charge connected an extra, remote loudspeaker to the F.M. receiver used to pick up the transmissions of the relay station, which was sending onward to Paxton the program from Boston, and raised the output volume of the loudspeakers to a point where it overshadowed the thunder. While the storm was going on, the visitors enjoyed the music and paid little or no attention to the conditions outside, while previous to that time their attention was all on the outside.

CONSTRUCTION

From the accompanying photographs and drawings it will be possible for the experienced constructor to duplicate the Frequency Modulation Adapter which we have built. By comparing the pictures, the circuit diagram and the List of Parts, it should be a simple matter to identify the location of all the component parts. The construction and the circuit are entirely straightforward and adjustment of the completed receiver follows normal practice. It will be observed that a view of the receiver has been made from the bottom, so as to enable the constructor to see those parts which would otherwise be obscured by a portion of the cabinet.

Considerably better performance is provided where an 1852 (6AC7) tube is employed in place of the 6SK7 in the radio frequency stage. The improvement is found in much better gain and results in considerably better limiter action. Another 1852, (6AC7) may be used in place of 6SK7V4 as indicated in the

ALL ABOUT FREQUENCY MODULATION

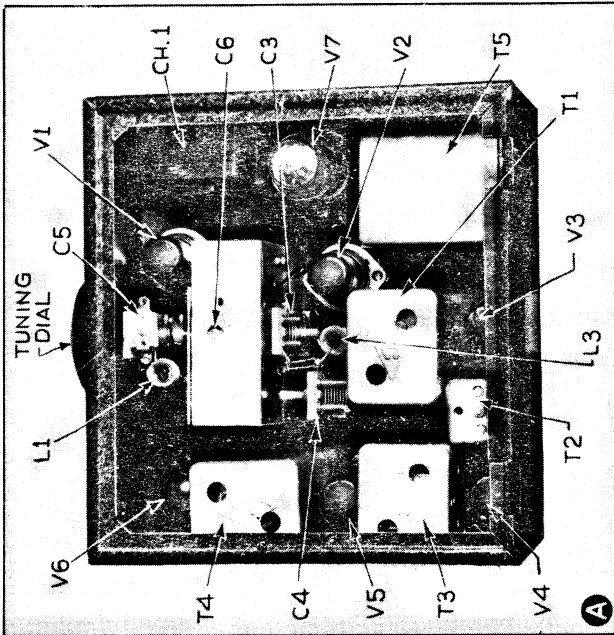

The neat and compact construction of this new F.M. Adapter is illustrated in photo A. Even an underviewer, photo B, will not scare the constructor.

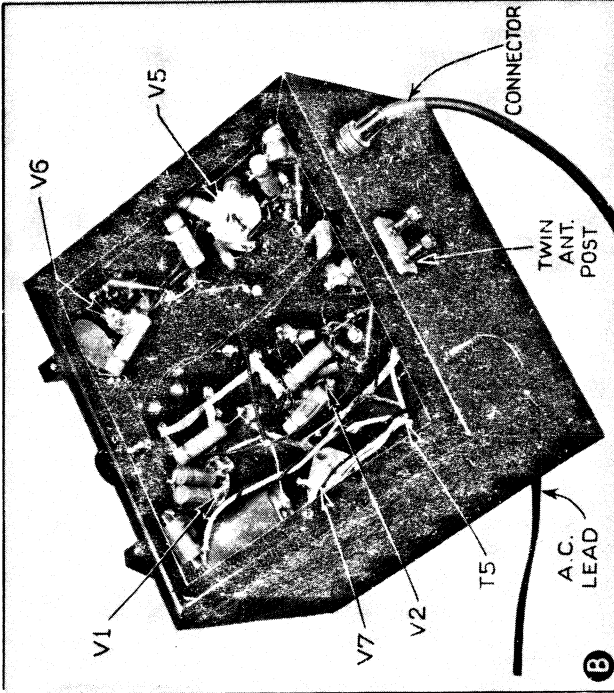

The meter with its series resistor should now be connected to both cathodes of the 6H6. Apply an unmodulated signal to the control-grid of the 6SJ7 and adjust the secondary trimmer of T4 for zero reading on the galvanometer. Rock the oscillator back and forth 100 kc. each side of 2,100 kc. and note that *the galvanometer should show an equal deflection either side of zero* as the frequency is changed. There should be a change of voltage proportionate to the change in frequency either side of the "center" frequency.

Now remove the series resistor and insert a meter in series with R18 at the point marked X. Apply an unmodulated signal to the control-grid of V4. Set the oscillator to 2,150 kc. and adjust the

ALIGNMENT

The materials needed for aligning the completed F.M. Adapter are a service oscillator and a 200-microamp. galvanometer. For aligning the discriminator, T4, a 0.1-meg. resistor must be inserted in series with the meter. With meter and series resistor connected across R23 apply a signal to control-grid of the 6SJ7. Using 2,100 kc. as the frequency of the I.F., and modulating with 400-cycle note, adjust the primary of T4 for maximum reading of the galvanometer.

ALL ABOUT FREQUENCY MODULATION

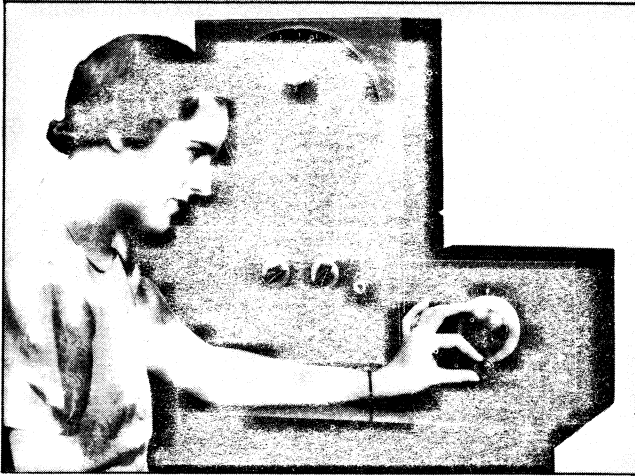

primary trimmer of T3 for maximum deflection of the meter. Next set the oscillator to 2,050 kc. and adjust the secondary trimmer for maximum reading. The oscillator should now be rocked 100 kc. either side of 2,100 kc., and meter readings taken at various positions, to make sure the transformer shows a symmetrical resonance curve. It is not necessary that the transformer have a flat top (of 200 kc.) but that it should be symmetrical. It is desirable that the signal should attenuate rapidly beyond the 2,000 kc. and 2,200 kc. points.

Apply a signal to the control-grid of V3 and proceed as above.

Short the oscillator coil to V2, apply a signal to the control-grid of V2, and adjust

T2 as before. Next disconnect the short on the oscillator coil and apply a modulated, 43-mc. signal to V2 and turn C4 until the meter in the control-grid circuit of V5 registers a reading. Now adjust trimmer C6 for maximum reading. Finally, apply a 43-mc. signal to the antenna terminal and adjust C5 to maximum. The band-width of R.F. is sufficient to pass the broad band.

When using a 6AC7/1852 in place of the 6SK7 more care must be taken in the placement of parts and in the laying of ground wires. Each circuit must be grounded at the socket to chassis and all points on the chassis connected together with ¼-in. braid. It may be desirable to use braid to ground the shield of the tube as wire has a higher R.F. resistance.

It may be necessary to insert a 15- to 25-ohm resistor in series with the control-grid of V2, at point X, to suppress parasitic oscillation.

Coil construction: L1, L2, L3—5 turns, on 9/16-in. form, spaced ⅝-in. and wound with No. 18 tinned wire. Primary—2 turns wound with No. 28 D.S.S. on lower end. Oscillator tapped 1½ turns from bottom. An I.F. of 2.1 mc. is used.

CREDITS

It was our purpose in providing this design to make the advantages of frequency modulation reception available to the more experienced constructor. It will be recognized that the receiver has been designed to use items which will be found in stock in most of the leading radio stores. The Serviceman should find this design extremely interesting because the construction of

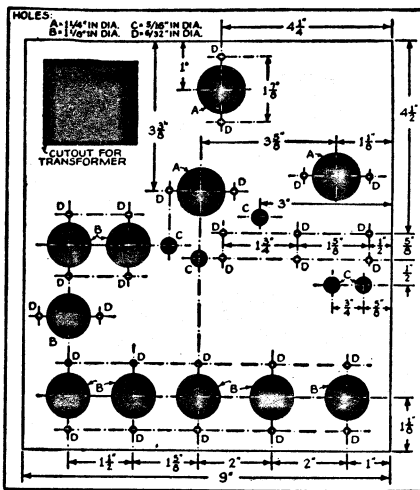

ALL ABOUT FREQUENCY MODULATION

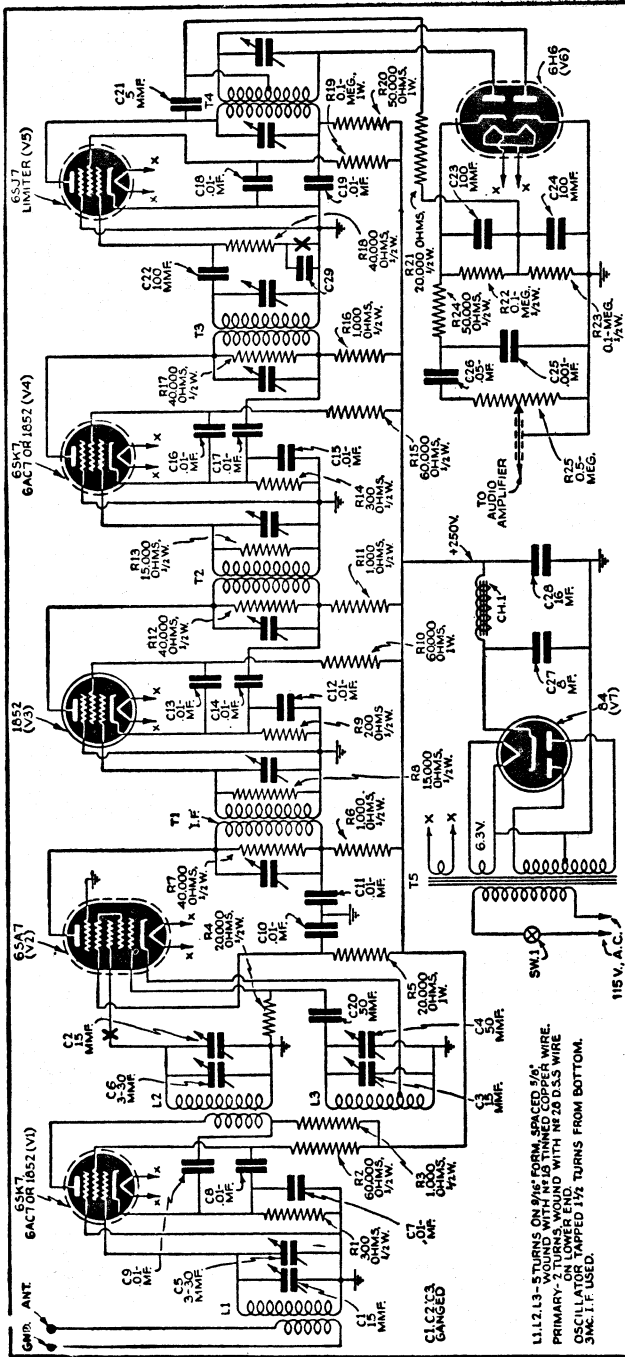

This F.M. Adapter may be used with headphones as a complete receiver; or it may be used to drive the A.F. section of any radio receiver or P.A. system.

such a unit will give him an insight into the operation of the receivers of this nature and will be very beneficial to him in handling service problems on the various F.M. sets now on the market. Connect a doublet antenna to terminals Ant. and Gnd.

The author desires to express appreciation for the assistance given him by Messrs. Shaughnessy, Day and Stiles, of Major Armstrong's laboratory.

The actual building of this receiver was done for the writer by Mr. Anton Schmitt, W2KWY, of the Harvey Radio Company of New York City; and the receiver has been thoroughly tested not only in the laboratory of the National Company at Malden, Mass., but also in the laboratory of Major Armstrong at Columbia University in New York City, and in the Radio Engineering Laboratories, Long Island City, N. Y.

LIST OF PARTS

- CONDENSERS
 Three National Co., type UM-15, C1, C2, C3;
 One National Co., type UM-50, C4;
 Two National Co., type 3-30, C5, C6;
 Fourteen Cornell-Dubilier, type DT-6S1, 0.01-mf., 600 V., C7, to C19 (incl.); C29;
 Two Cornell-Dubilier, type 5W-6Q5, 50

ALL ABOUT FREQUENCY MODULATION

mmf., C20, C21 (*erroneously indicated in diagram as 5 mmf.*);
Three Cornell-Dubilier, type 5W-5T1, 100 mmf., C22, C23, C24;
One Cornell-Dubilier type, 1W-5D1, 0.001-mf., C25;
One Cornell-Dubilier, type DT-4S1, 0.05-mf., 600 V., C26;
One Cornell-Dubilier, type BR-845, 8 mf., 450 V., C27;
One Cornell-Dubilier, type BR-1645, 16 mf., 450 V., C28;

RESISTORS
Two I.R.C., type BT½, 300 ohms, R1, R14;
Four I.R.C., type BT½, 1,000 ohms, R3, R6, R11, R16;
Two I.R.C., type BT½, 20,000 ohms, R4, R21;
Four I.R.C., type BT½, 40,000 ohms, R7, R12, R17, R18;
Two I.R.C., type BT½, 15,000 ohms, R8, R13;
One I.R.C., type BT½, 200 ohms, R9;
Two I.R.C., type BT½, 0.1-meg., R22, R23;
One I.R.C., type BT½, 50,000 ohms, R24;
Three I.R.C., type BT1, 60,000 ohms, R2, R10, R15;
One I.R.C., type BT1, 20,000 ohms, R5;
One I.R.C., type BT1, 0-1-meg., R19;

One I.R.C., type BT1, 50,000 ohms, R20;
One I.R.C. potentiometer, type 13-133, 0.5-meg., R25;

TUBES

One Sylvania or RCA 6SK7, or 1852 (see text), V1;
One Sylvania or RCA 6SA7, V2;
One Sylvania or RCA 1852 (see text), V3;
One Sylvania or RCA 6SK7, or 1852 (see text), V4;
One Sylvania or RCA 6SJ7, V5;
One Sylvania or RCA 6H6, V6;
One Sylvania or RCA 84, V7;

MISCELLANEOUS

Three National Co. I.F. transformers, T1, T2, T3;
One National Co. discriminator transformer, T4;
One United Transformer, A.F. transformer type R-54, T5;
One Thordarson choke, Ch.1;
One Hart & Hegeman roto switch, Sw. 1;
One National Co. steel cabinet, type C5W-3 (the subpanel comes with this cabinet);
One National Co. dial, type 0, with No. 2 scale;
One National Co. dial drive, type ODD;
Two National Co. knobs, type HRP.

CHAPTER III

AUDIO AMPLIFICATION

F.M. AUDIO AMPLIFIER

FOREMOST among problems presented by Frequency Modulation is the design of an amplifier which will not prove to be the "bottle neck" of the entire system. The new standards set by the Federal Communications Commission for designing F.M. transmitters, that should be taken into consideration when designing an audio amplifier for F.M. receivers, briefly follow:

- (1) The transmitter and associated studio equipment shall be capable of transmitting a band of frequencies from 50 to 15,000 cycles within 2 decibels of the level of 1,000 cycles. In addition, provision shall be made for pre-emphasis of the higher frequencies in accordance with impedance frequency characteristics of a series inductance-resistance network, having a time constant of 100 micro-seconds.
- (2) The noise in the output of the transmitter in the band 50 to 15,000 cycles shall be at least 60 decibels below the audio frequency level represented by a frequency swing of 75 kilocycles (100% modulation).
- (3) At any frequency between 50 and 15,000 cycles at a swing of 75 kilocycles the combined audio frequency harmonics generated by the transmitting system shall not be in excess of 2% (root mean square value). This means, simply, that the transmitter should be capable of passing a band of 50 to 15,000 cycles ± 2 db. of the 1,000-cycle reference; it shall have a combined hum and noise level at least 60 db. below full power output; and, it should not generate more than 2% total

harmonics at any frequency within its transmitted band.

F.M. A.F. AMPLIFIER STANDARDS

In setting up standards for an F.M.-receiver audio amplifier the natural reaction would be to use the standards set for the F.M. transmitter. Careful consideration, however, will reveal specific disadvantages for such an arrangement.

It is obvious that for ideal performance, the amplifier at the receiving end should have an effectively flat frequency response, introduce no distortion and have no inherent noise. With such an ideal amplifier, the full benefits of frequency modulation will be obtained.

Any discriminating characteristics inherent within the receiving amplifier will, of necessity, introduce additional detrimental conditions, which are added to existing deficiencies within the transmitter to provide an overall result far below a desirable ideal. For example, let us assume that the transmitter is down 2 db. at 50 cycles. The receiving amplifier (which was built in accordance with the standards set for F.M. transmitters) is also down 2 db. at 50 cycles. The overall result will be a 4 db. loss at this low frequency, which is sufficient to change the character of many types of music. Similarly, an amplifier which introduces 2% distortion (say at an average level of 1 watt) will provide an ultimate program having a combined distortion of more than 2% (which we can assume was produced by the transmitter). It therefore follows that the amplifier should be definitely better than the transmitter.

In addition to this, it is also feasible to assume that additional improvements will be made in F.M. transmitters, and F.C.C. regulations may tighten their specifications. If this occurs, an amplifier which has been built to existing standards may not pass on to the listener all the benefits of future improvements in F.M. transmission. *The present specification covering the width of the audio band is unbalanced,** and it is reasonable to assume that, in time, the lower portion of the band will ultimately be extended to at least 26 cycles to produce a balanced spectrum.

Proof of this line of reasoning can be found in new F.M. transmitters, which are being constructed to exceed the F.C.C.'s F.M. requirements. For example, one of

*See "Balanced Audio Spectrums," *Radio-Craft*, Sept., 1940, pg. 164.

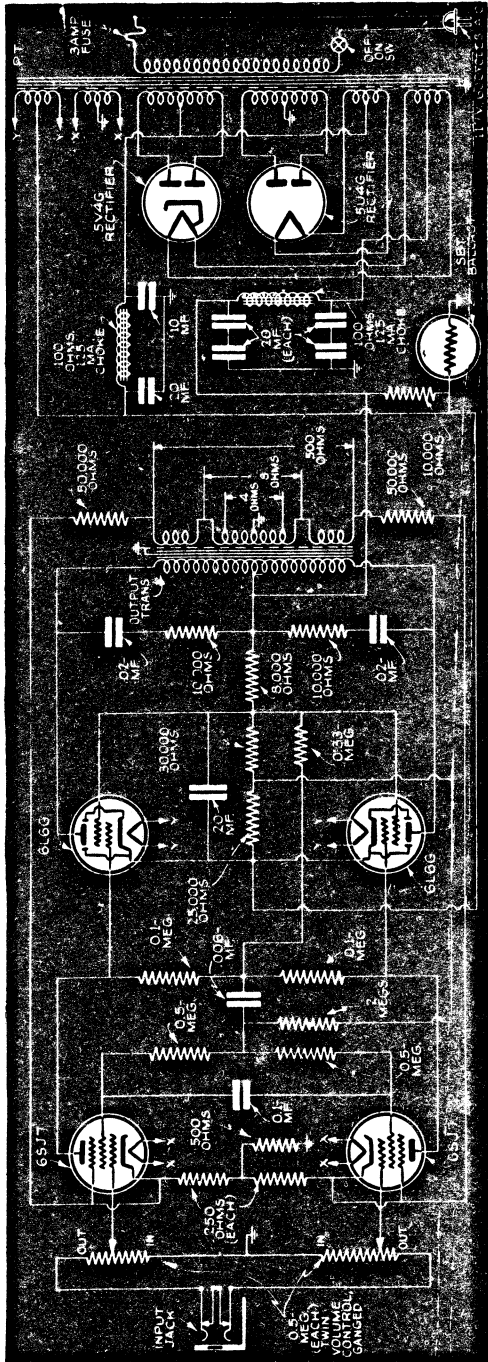

Schematic circuit of the Push-Pull Direct-Coupled Frequency Modulation A.F. Amplifier. It incorporates balanced negative-feedback and novel A.C. and D.C. balancing circuits.

the largest manufacturers of transmitters guarantees the following audio characteristics:

- (1) Frequency Response—Flat ± 1 db. from 30 to 15,000 cycles.
- (2) Noise Level—70 db. below full modulation.
- (3) Distortion—Less than 2%, total harmonics.

It was therefore decided to anticipate a reasonable amount of improvement and design this F.M. amplifier so as to prevent obsolescence. The following tentative specifications were set:

- (1) Frequency Response— ± 1 db. from 13 to 30,000 cycles.

- (2) Noise Level—At least 75 db. below rated power output.

- (3) Distortion—1% (at average working level), total harmonics.

With an amplifier of this type, it was felt no ultimate consumer would ever have to worry about having the "bottle neck" of an F.M. program in his audio amplifier equipment.

Furthermore, reasonable improvements in F.M. transmitters (based on similar improvements which have taken place in A.M. work) will provide direct benefits to the listener.

SELECTING THE FEATURES

The Equalizer

Offhand, it would appear that an F.M. Amplifier should be built to meet ideal requirements and have unvarying characteristics. In other words, the amplifier should be devoid of high-frequency or low-frequency controls. Referring to the requirements set by the F.C.C., it will be noted that provision *must* be made in every F.M. transmitter to pre-emphasize high frequencies. This means that high frequencies will be accentuated during transmission. The purpose of this pre-emphasis is to attenuate residual atmospherics.

ALL ABOUT FREQUENCY MODULATION

As disturbing effects of atmospheric are predominant in the higher audio frequencies, it is logically assumed that accentuation at the transmitter and attenuation at the receiver will ultimately result in a flat overall response and at the same time, materially attenuate atmospheric. This is graphically illustrated in Fig. 1.

If we assume that a high-frequency program signal has a level of +20 VU and it is pre-emphasized to a level of +23, this signal will be received along with an atmospheric disturbance of say +20. Hence, without pre-emphasis, the original program signal and the atmospheric will be of equal intensity. On the other hand, pre-emphasis has already made the program signal appreciably higher than the atmospheric. By attenuation in the receiver, the program signal is brought back to its original level of +20 VU, and the atmospheric is reduced 3 VU. The degree of attenuation of disturbances is a function of the pre-emphasis at the transmitter.

From a casual study of this operating procedure, it would appear that a high-frequency attenuator is the only required control of the receiver. A study of existing deficiencies in present records, however, will

clearly indicate that both the high and low frequencies should be independently controlled, and the control range should provide for both attenuation and accentuation. Another very desirable characteristic in the equalizer circuit is to have it exactly complement the equalizer used at the transmitter or in the recording studio (for recorded programs). The equalizer should not introduce harmonics, hum, or resonant peaks in any portion of the spectrum.

The VU Meter

It was also considered desirable to have a visual monitoring arrangement so as to indicate normal, average, and peak levels of the program. This auxiliary feature is highly desirable when it is required to avoid overload of either the amplifier or the loud-speaker. Low-frequency speaker overload is usually judged from a distortion viewpoint, because the intensity of the signal cannot be accurately judged in view of the fact that the ear is comparatively insensitive to low frequencies. Only critical listeners, therefore, will detect overload at low frequencies. The use of the meter, however, makes it possible for any average individual to adjust the intensity of the program level so as to definitely prevent overload at any frequency. Furthermore, it becomes relatively simple to detect just what actual effect the various settings of the equalizer controls have upon the overall program level.

Dual-Channel Input and Electronic Mixer

In order to extend the usefulness of this Direct-Coupled F.M. Amplifier, it was considered desirable to incorporate an additional input circuit so that phonograph records, in addition to F.M. transmissions, may also be enjoyed.

A dual circuit input could most economically be employed by the use of a change-over switch, but inasmuch as the average volume level of the radio program and the recorded program may be different (and therefore necessitate a continual change), it was thought more desirable to incorporate an electronic mixer. This provides 2 entirely independent input channels with independent controls so that each level may be set for ideal results. Furthermore, the use of the electronic mixer insures complete isolation of both controls, so that they do not affect either the volume or the frequency response characteristics of its associated channel.

Details covering the design of these 3 features will be described in Part II of this article. A block diagram which shows the relative position of the various features is given in Fig. 2.

THE AMPLIFIER

As all of the several 10-, 20- and 30-Watt Direct-Coupled Amplifiers previously described in this magazine have been designed around an effective drift-correcting circuit, no immediate improvement in stability seemed apparent. Subsequent investigation, disclosed that unusual difference in plate resistances of the input tubes affected the performance of direct-coupled amplifiers more than resistance-coupled units. This difference in effect was to be expected to be noticeable because of the increased efficiency, improved response, and lower noise level characteristic of direct-coupled amplifiers. Upon further investigation, it was found that manufacturers of tubes had not set close standards for plate resistance of preamplifier and voltage amplifier tubes.

Although normal variations in tubes produce a measurable difference in the performance of the resistance- and transformer-coupled amplifiers, they have been found to produce another effect in direct-coupled amplifiers. For example, an unbalanced pair of input tubes would unbalance the plate current or the output tubes sufficiently to increase residual hum and require readjustment of the hum-balancing adjustment. It was therefore decided that 2 self-correcting networks would be incorporated in this new amplifier; one to automatically balance for difference in the

ALL ABOUT FREQUENCY MODULATION

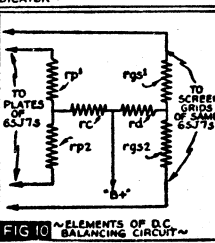
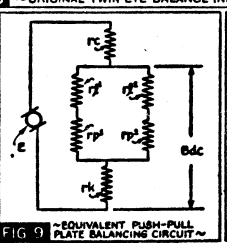
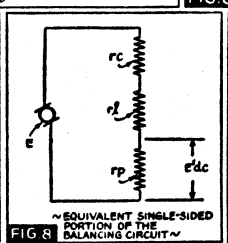
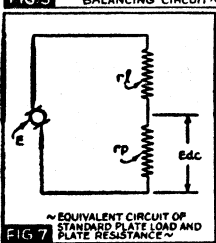
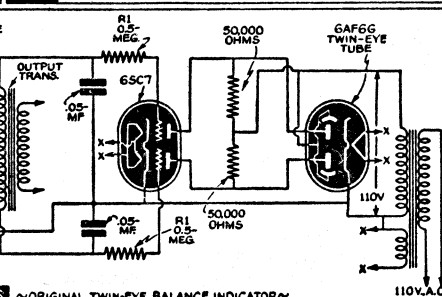
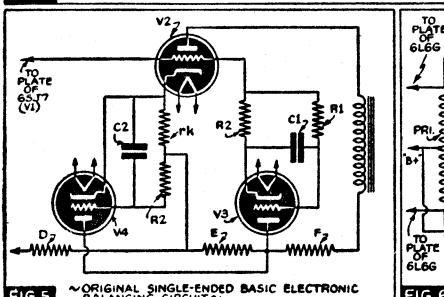
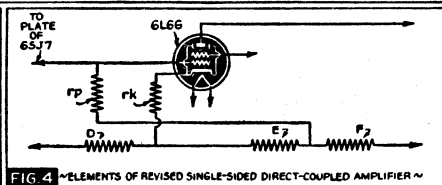
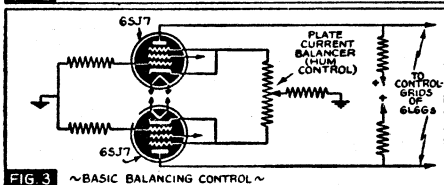
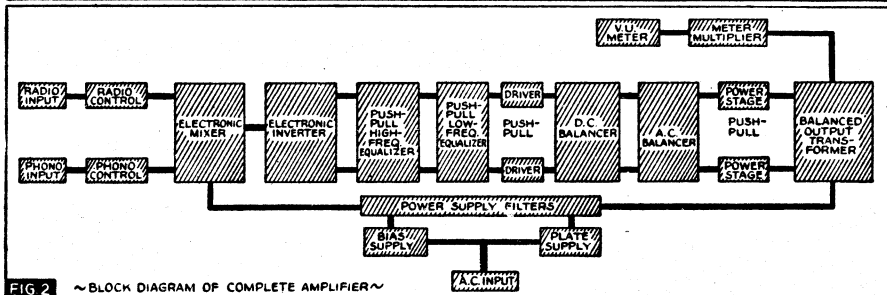
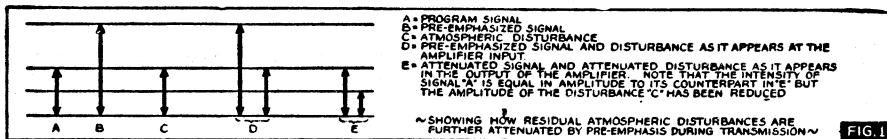

plate resistance of the driver tubes and the other to automatically balance for difference in gain of the driver tubes. As a further requisite, it was decided that these circuits should provide for superior results in the direct-coupled amplifier as compared to a standard resistance-coupled amplifier with a given set of greatly unbalanced (or even defective) tubes.

THE D.C. BALANCING CIRCUIT

During the development of the 30-Watt Direct-Coupled Amplifier,* it was found that a normal variation between tubes could be compensated-for by correcting the bias on the input tubes. The basic portion of this manual balancing circuit is illustrated in Fig. 3.

ALL ABOUT FREQUENCY MODULATION

Fortunately, when an unbalance of more than 10 milliamperes occurred in the output stage, the hum level came up. It therefore became a relatively simple matter to balance the input tubes by adjusting for minimum hum. With a change of input tubes, it was sometimes necessary to readjust the initial setting. It was found, however, that some of the ultimate users of these amplifiers would insert greatly-unbalanced tubes, without attempting to readjust for balance. It was therefore believed highly desirable to provide some automatic means for balancing. The first method of attack which presented itself was to use a tube in place of the load resistance of the voltage amplifier and arrange for automatic compensation for variations in plate resistance of the voltage amplifier. Another tube was to be used to augment the bias of the output tubes, so as to compensate for variations in output plate current.

In Fig. 4, which shows the elements of a revised single-sided direct-coupled amplifier, R_p is the plate resistance of the voltage amplifier and R_k is the partial cathode resistor of the power amplifier.

Figure 5 shows the basic balancing circuit originally conceived to automatically compensate for both variations in plate resistance of the input tube V1 and the output tube V2. It will be noted that V3 is used as a plate load resistor for V1. The bias applied to V3 through R1 depends upon the plate current flowing through its cathode resistor R2. The time-delay constant of R1, C1, prevents signal frequencies from affecting a change in the plate resistance of V3, and limits automatic adjustments only for "steady state" or average conditions; V4 was to be used as a shunt across R_k , so as to keep the bias across R_k constant. This circuit is likewise made responsive only to steady state or average unbalance, by inserting a time lag through the resistor-condenser network R2-C2.

Inasmuch as the final amplifier was to be push-pull throughout, 4 additional tubes would be required for this balancing action. The added expense and complexity of this circuit inspired additional research to produce a simpler and more economical circuit to achieve the desired results.

A side project was started to adapt the use of the twin indicator (6AF6G) through a twin-triode amplifier (6SC7), so arranged as to measure the voltage drop across the balanced primary winding of the output transformer. A special transformer was wound so that both sides of the primary were of equal D.C. resistance (and equal A.C. impedance). The idea behind this development was to provide a partially visual check on the plate current of the output tubes so that should greatly un-

balanced tubes be used, it would become immediately visible, and the tube would provide for readjustment. It was found, however, that the indicator with its associated amplifier was too insensitive for the average user to adjust within a 10-ma. balance. This circuit was therefore abandoned, but it is given in Fig. 6 for the benefit of some readers who may have other applications for this particular type of indicator. The condenser-resistor network R1-C1 provides a time delay to prevent A.C. potentials from having any effect upon the twin-eye indicator. A novel portion of the circuit is that raw A.C. is applied to the plates of the indicator. The flicker is not observed because of the persistence of vision of the eye which will tolerate interrupted images down to about 16 cycles before flicker becomes visible.

The easiest way to understand the action of the final D.C. balancer is to substitute a resistor (r_l) for the plate load and another (r_p) for the plate resistance of the tube. If a D.C. voltage E (as indicated in Fig. 7) is applied across this network, the voltage E_{dc} is the effective voltage applied to the plate of the tube and is dependent upon the voltage drop across r_l . Thus, if r_p is varied from zero to infinity, the voltage will vary proportionately. The ratio of voltage change will depend upon the ratio

of $\frac{r_p}{r_l + r_p}$. If r_l is made large in comparison to r_p , the ratio of change will be small.

If an additional resistor (r_c) is inserted in series with both r_l and r_p , as indicated in Fig. 8, then the effective voltage E'_{dc} would be equal to $\frac{r_p}{r_c + r_l + r_p}$. The push-

pull version of this circuit is indicated in Fig. 9. If we neglect r_k (which is very small) the voltage which appears across $r_l' + r_p'$, is equal to B_{dc} which can be calculated from

$$B_{dc} = \frac{(r_l^1 + r_p^1)(r_l^2 + r_p^2)}{r_p^1 + r_l^1 + r_p^2 + r_l^2} + \frac{r_c}{r_p^1 + r_p^2 + r_l^1}$$

If r_l^1 is 100,000, r_c is 500,000, and r_p^1 varies from 800,000 to 120,000 (which represents a \pm variation of approx. 20%), it will be found that the percentage of change at B_{dc} is 1.9% as compared to a 4% change which would take place under conditions of Fig. 7. In other words, a 50% correction is affected. If the same type of network is applied to the screen-grids of the driver

ALL ABOUT FREQUENCY MODULATION

tubes, as indicated in Fig. 10, still more correction is affected.

The practical value of this self-balancing circuit can best be indicated by referring to laboratory data compiled during its development. A total of 100 average 6SJ7 tubes were checked for the maximum deviation they produced in the output plate circuit of the 6L6G's. Two sets of the worst combination produced the following results:

| <i>Unbalanced Tube Numbers</i> | <i>Output Unbalance</i> |
|------------------------------------|-----------------------------|
| 1 and 2 | 61 ma. |
| 1 and 3 | 68 ma. |

When these same tubes were inserted into the balancing circuit, the following results were noted:

| <i>Unbalanced Tube Numbers</i> | <i>Output Unbalance</i> |
|------------------------------------|-----------------------------|
| 1 and 2 | 8 ma. |
| 1 and 3 | 8 ma. |

As the D.C. balancer becomes an integral part of the A.C. balancer circuit as well, it was necessary to select optimum resistor values which would provide a minimum D.C. unbalance and minimum A.C. unbalance. The design of the A.C. balancer circuit will be discussed in Part II.

F. M. AUDIO AMPLIFIER

PART II

In an effort to surpass the stability of conventional transformer- and resistor-coupled amplifiers, a combined D.C.-A.C. balancing circuit was developed. The *D.C. balancer* provides for automatic audio-drift correction under static conditions. The *A.C. balancer* provides for automatic signal balancing under dynamic conditions.

Stated in other words, the static balancer (D.C. corrector) automatically compensates for a very wide variation in plate resistance characteristics of input tubes. It prevents unbalance in the output stage with change of emission characteristics within the input stage. The dynamic balancer (A.C. corrector) automatically compensates for a very wide variation in voltage amplification of input tubes. It prevents the application of unbalanced signals to the control-grids of the output stage.

THE DYNAMIC BALANCER (A.C. CORRECTOR)

The easiest way to understand the operating principles of this unusually effective circuit is to analyze the basic operating principles of the screen-grid tube. This tube is normally used in a conventional manner, i.e., by applying a control voltage to the control-grid; a "B+" voltage, adequately bypassed to the screen-grid; a "B+" voltage, through the load resistor to the plate; and, its suppressor-grid connected to cathode.

If these elements are viewed fundamentally as diagrammed in Fig. 1, it will be noted that all of the grids are in the electron stream. This means that any one of them can be used as a control-grid. Naturally, the further away the grid is from the emitter (cathode), the less control it has upon the electron stream. If the grids are labelled G1, G2, and G3, in order of their distance from the cathode, these notations will correspond to control-grid, screen-grid, and suppressor-grid, respectively.

Figure 2 shows a standard circuit, wherein the input signal (e) is applied to the control-grid, a signal V_{ae} will appear at the plate. This voltage will be out-of-phase with the input signal. If the screen-grid bypass condenser, C , is disconnected, and the voltage e is applied in series with the condenser, as illustrated in Fig. 3, a voltage $V_{a'e}$ will appear on the plate. V_a may be defined as the control-grid to plate voltage amplification. $V_{a'}$ may also be defined as the screen-grid to plate voltage amplification. It is therefore obvious that the screen-grid can be used as a control-grid. This particular application is important as it plays a prime role in our dynamic balancer.

The suppressor-grid may likewise be used as the control-grid in which case, the voltage which appears at the plate would be equal to $V_{a''}e$ (wherein $V_{a''}$ may be looked upon as the suppressor-grid to plate voltage amplification).

ALL ABOUT FREQUENCY MODULATION

PRINCIPLES OF DYNAMIC BALANCING

With the above phenomenon kept in mind, a review of fundamental balancing circuits will further simplify the operating principles of the dynamic balancer. If an A.C. generator **E** is applied to a series resistive network **R1, R2**, as illustrated in Fig. 4, the voltage (**E**) appearing across **R2** is equal to $\frac{R_2 E}{R_2 + R_1}$.

Expressed mathematically, it becomes
$$e = \frac{R_2 E}{R_2 + R_1}$$

If another identical generator **F** is connected to a similar resistance network **R1, R2**, the voltage (**f**) which appears across **R2** is likewise equal to $\frac{R_2 F}{R_2 + R_1}$. If both

circuits of Figs. 4 and 5 are connected together, so that **R2** becomes a common return, Fig. 6 results. If the generators **E** and **F** are so adjusted as to be equal in potential but opposite in phase, and $R_1 = R_1'$, the following voltage conditions are present:

- (1) The voltage across **E** (**e**) is obviously equal to the voltage across **F** (**f**).
- (2) The voltage across **R1** (**e1**) is equal to the voltage across **R1'** (**e'1**).
- (3) As the voltages are out-of-phase, it is also obvious that the voltages across **R2** will cancel, and equal 0.
- (4) The voltages across **X** and **Y** (**e xy**) will also cancel and be equal to 0.

The above conditions are prevalent only when the generators are opposite in phase and of equal potential. If we assume, however, that one of these generators drops in voltage, let us say to 50%, of its original value, it is apparent that the total difference will be equal to $e - f$ or $e - xy$. With an un-

balance in the generators it is further apparent that complete cancellation will not occur across **R2**. In fact, some of the larger voltage will appear at this point. This voltage ($e' - xy$) is equal to

$$E \frac{R_2}{R_2 + R_1} - F \frac{R_2}{R_2 + R_1} = e' - xy$$

An examination of this formula shows that as **R2** is increased, more of the unbalanced voltage appears across it. If this voltage unbalance ($e' - xy$) is applied back to **F**, so as to increase its voltage output, it is obvious that some balance will automatically be obtained.

THE DYNAMIC PLATE BALANCER

How this is actually done in the amplifier can best be indicated by redrawing Fig. 6 and replacing **E** and **F** by their respective tube circuits, as indicated in Fig. 7. In this circuit, the push-pull generator **EF**, takes the place of the original generators **E** and **F**. **R1** becomes the independent plate loads

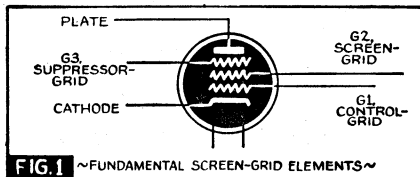

FIG. 1 ~ FUNDAMENTAL SCREEN-GRID ELEMENTS ~

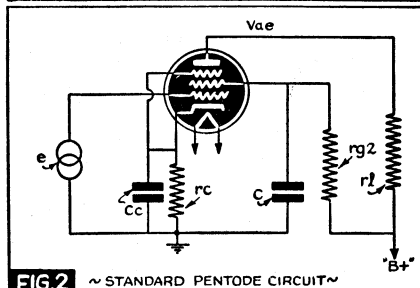

FIG. 2 ~ STANDARD PENTODE CIRCUIT ~

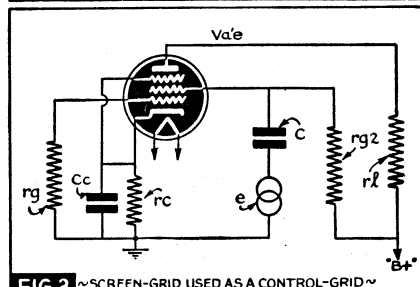

FIG. 3 ~ SCREEN-GRID USED AS A CONTROL-GRID ~

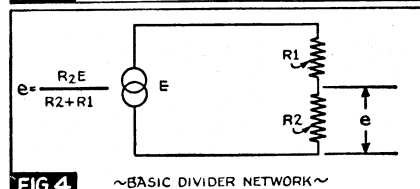

FIG. 4 ~ BASIC DIVIDER NETWORK ~

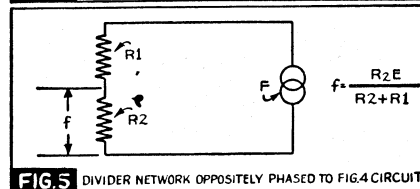

FIG. 5 DIVIDER NETWORK OPPOSITELY PHASED TO FIG. 4 CIRCUIT

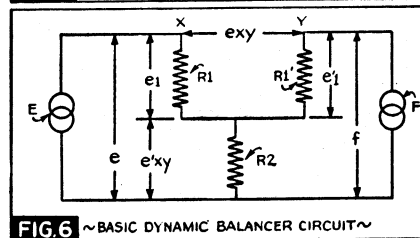

FIG. 6 ~ BASIC DYNAMIC BALANCER CIRCUIT ~

ALL ABOUT FREQUENCY MODULATION

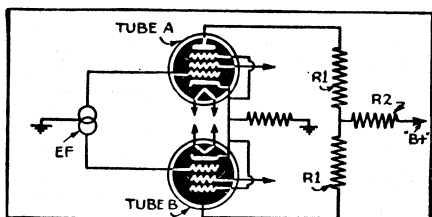

FIG. 7 ~THE DYNAMIC PLATE BALANCER CIRCUIT~

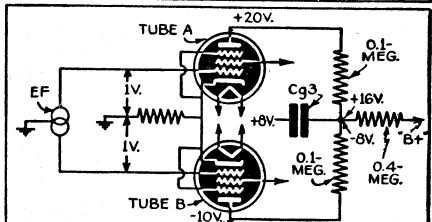

FIG. 8 ~SHOWING THE PORTION OF THE DIFFERENCE VOLTAGE WHICH APPEARS AT Cg3~

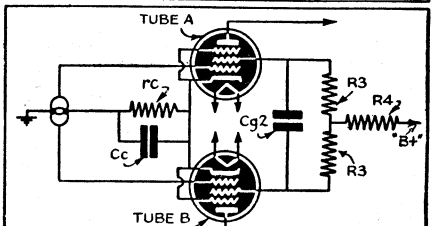

FIG. 9 ELEMENTS OF THE DYNAMIC SCREEN-GRID BALANCER

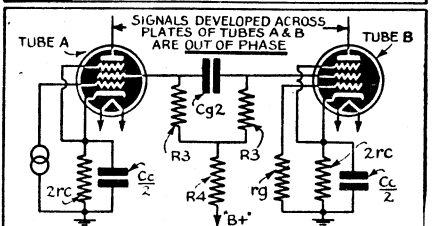

FIG. 10 ~EQUIVALENT CIRCUIT OF FIG. 9 (ONE CONTROL-GRID RECEIVES NO SIGNAL)~

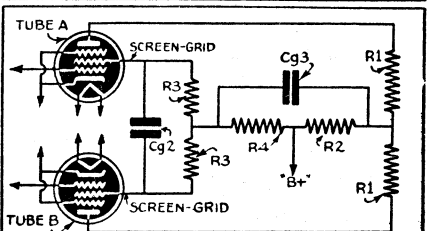

FIG. 11 ~THE AUXILIARY REGENERATIVE EQUALIZER. DIFFERENTIAL VOLTAGE ACROSS R2 DRIVES BOTH SCREEN-GRIDS THROUGH CONDENSER Cg3~

of both tubes, while R2 becomes the common degenerative resistor. If both tubes A and B have identical voltage amplification characteristics, the voltage which appears across R2 will be 0. On the other hand, if A has

twice the voltage amplification of B, then a portion of this difference will appear across R2.

A typical example is given in Fig. 8, wherein the plate load resistors R1 equal 100,000 ohms each, the common degenerative resistor R2 is equal to 400,000 ohms. If we assume that the voltage amplification of one tube (A) is 20, and the other tube (B) is 10, and if a balanced push-pull signal (grid-to-grid of 2 volts) is applied to the input of the circuit, the voltage which appears at the plate of A is equal to say, +20 volts (the voltages indicated are instantaneous A.C. voltages). The voltage which appears at the plate of B is equal to -10 volts. If these signals are out-of-phase, there will be a total voltage difference between both plates of 30 volts (for ideal conditions, there should be a total voltage difference of either 20 volts [if both plates have 10 volts each] or 40 volts [if both plates have 20 volts each]).

The portion of the voltage developed by plate A which appears across the 400,000-ohm resistor, is equal to

$$+ 20 \times \frac{400,000}{400,000 + 100,000} = 20 \times \frac{4}{5} = + 16 \text{ volts}$$

The portion of the voltage developed by plate B which appears across the 400,000-ohm resistor is equal to

$$- 10 \times \frac{400,000}{400,000 + 100,000} = -10 \times \frac{4}{5} = - 8 \text{ volts}$$

The cancellation which occurs across the 400,000-ohm resistor is equal to 16 - 8 or + 8 volts. This instantaneous value of + 8 volts is fed back to the screen-grids of both tubes to affect further automatic connection. Before considering the balancing action of this voltage, let us briefly look into the screen-grid circuit.

THE DYNAMIC SCREEN-GRID BALANCER

The fundamental principles involved in the dynamic screen-grid circuit are virtually identical with those for the plate dynamic balancer. There are, however, 2 important exceptions.

In our conventional circuit of Fig. 2, it will be noted that the screen-grid was bypassed to ground through C. If this condenser is entirely removed, a voltage will appear at the screen-grid, which is equal to $V_{a''e}$ ($V_{a''}$ being the control-grid to screen-grid voltage amplification). If the rest of the circuit of Fig. 2 remains unchanged, it will be found that the voltages V_{ae} and $V_{a''e}$ will be in-phase. The voltage V_{ae} however will be decreased. This is caused by the degenerative action of the voltage which appears at the screen-grid. Its degenerative action can best be analyzed by referring again to Fig. 1. If a positive instantaneous voltage is applied to G1, the electron stream is increased. The increased

ALL ABOUT FREQUENCY MODULATION

current through G2, produces a drop across its supply resistor. This, in turn, decreases the applied potential of C2 to retard the flow of electron streams to the plate. As the control-grid to screen-grid voltage amplification increases, the control-grid to plate voltage amplification decreases. Very large signals can easily be handled by the screen-grid under this condition.

Figure 9 shows the elements of the dynamic screen-grid balancer circuit, arranged to simulate the plate dynamic balancer of Fig. 8. It will be noted, however, that an essential difference is the inclusion of the condenser Cg2. If the control-grid to screen-grid characteristics are identical in both tubes, complete cancellation of the voltages which appear at both screen-grids will take place, as discussed for the conditions illustrated in Fig. 6. Let us assume for a moment however, that the control-grid to screen-grid characteristics of tube B, are lower than that of A. This naturally means that complete cancellation will not take place across both screen-grids and a residual potential will appear at the screen-grid of tube A. This voltage will then drive the screen-grid of B in a very conventional resistance-coupled circuit, which can easily be perceived by redrawing Fig. 9, as indicated in Fig. 10.

Here it will be noted that the screen resistor R3 of tube A acts as an equivalent "plate load". Condenser Cg2 assumes the role of the common coupling condenser. The screen-grid of B acts as the control-grid. The voltage which appears at the plate of B will be out-of-phase with that which appears at the plate of A because of the following reasons: when the control-grid of tube A is being used as a driver, and it becomes instantaneously positive, both the plate and its screen-grid become instantaneously negative. The negative screen-grid of tube A is coupled to drive the screen-grid of tube B negatively. This in turn produces an instantaneous positive potential at the plate B.

With correct selection of values, this circuit may be made to operate as a perfect inverter, and shows how complete balancing may be attained even though the control-grid of tube B is entirely inoperative. In actual practice, however, such a condition is rarely encountered. What usually happens is the control-grid to screen-grid voltage amplification of both input tubes are not always equal. This coupling circuit equalizes the difference within the first stage so that practically equal—but oppositely-phased voltages appear at the push-pull output plates of A and B.

In addition to the dynamic screen-grid balancer and the dynamic plate balancer, there is an auxiliary regenerative balancer which comes into play when the common

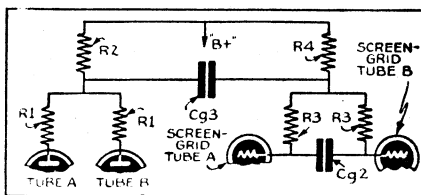

FIG. 12 SIMPLIFIED VERSION OF THE DIFFERENTIAL DRIVER CIRCUIT OF FIG. 11

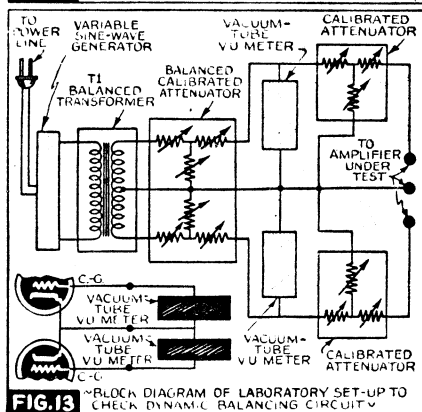

FIG. 13 BLOCK DIAGRAM OF LABORATORY SET-UP TO CHECK DYNAMIC BALANCING CIRCUIT

coupling resistor of the plate supply, R2 is coupled to the common coupling resistor of the screen supply, R4, through condenser Cg3, as indicated in Fig. 11. If we redraw this schematic again so as to take the form of a more familiar coupling circuit, we have Fig. 12. Here, it will be noted, the full potential difference which appears across R2 (400,000-ohm resistor of Fig. 8) is applied through Cg3 and through both R3 resistors directly to the screen-grids of both tubes. If we assume that the control-grid to screen-grid voltage amplification of both tubes is equivalent (for simplicity of explanation), then the residual instantaneous +8 volts of Fig. 8 is applied directly to both screen-grids without any additional cancellation. This instantaneous positive voltage also acts as a driving voltage to the screen-grid of tube B to further increase the negative swing of its plate. In actual practice, circuit values can be adjusted to automatically correct for any desired range of variation between tubes. Laboratory tests, however, simplify the determination of optimum values for maximum D.C. static correction, maximum A.C. dynamic correction and minimum loss of overall gain.

LABORATORY TEST SET-UP

For checking the degree of balance obtainable, the laboratory equipment indicated in Fig. 13 was used. The coupling transformer T1 was used to obtain a push-pull signal. Two vacuum-tube VU meters were

ALL ABOUT FREQUENCY MODULATION

used across each half of the push-pull input signal to enable exact adjustments of input voltages. Individual calibrated attenuators were used to vary the amount of input signal fed into each half of the push-pull stage.

It was found that when full signal was fed into one grid and no signal into the other, a 50% balance occurred. In other words, one output grid developed a voltage 50% of the other and exactly 180° out-of-phase. With a 50% variation in input signal, 80% balancing occurred. In other words, when half as much signal was fed into one

input grid, as compared to the other, its associated output grid had 4/5 of the voltage which appeared on the opposite push-pull output grid. This signal was also exactly 180° out-of-phase. Both of these conditions represent extreme abnormalities. Over 100 combinations of input tubes were checked for variations in voltage amplification. It was found that the greatest variation of tubes produced a difference of less than 5% between both output grids.

How this output grid voltage is further balanced by the action of the feedback circuit will be explained in the next part.

F. M. AUDIO AMPLIFIER

PART III

A NUMBER of questions have been repeatedly asked of the writer since the initial article describing this F.M. amplifier appeared. Among these were: "Why is it necessary to extend the range of the amplifier from 13 to 30,000 cycles?"

"Why is a 24-watt amplifier required for reproduction of phono or F.M. programs in an average home?"

Both of these questions are answered in this article, after the technical description has been completed.

THE BALANCED FEEDBACK CIRCUIT

The voltage which appears in the balanced 500-ohm winding of the output transformer is fed back to the cathode circuit of the 6SJ7 drivers through a bridged circuit. This particular feedback circuit can best be studied by redrawing the original circuit, which appeared in part one, as shown in Fig. 1 herewith.

An analysis of this bridge circuit will show that, under normal conditions, no voltage will appear from cathode to cathode of the input tubes. The A.C. voltage across rk_2 will be equal to 0. If the feedback resistors rb , rb_1 , or the cathode resistors rk , rk_1 , or the feedback windings, are unbalanced, a voltage will be present across rk_2 . As the input tubes are operating in push-pull, the voltage which appears across rk_2 must be in-phase with one of the cathodes, and out-of-phase with the other. It therefore degenerates with the cathode circuit with which

it is in-phase, and regenerates with the circuit with which it is out-of-phase. This action, in turn, tends to further balance the voltage across the plates of the driver tubes. Its overall effect greatly increases the overall dynamic stability of the amplifier.

The advantages of running the feedback loop from the secondary of the output transformer back to the cathodes of the input tubes are as follows:

- (1) By embracing the output transformer, the feedback loop corrects for frequency discrimination.
- (2) Most effective circuit stability is attained by coupling the balanced output feedback circuit directly to the push-pull drivers.

If the feedback voltages were taken directly from the plates of the output tubes, it is apparent that compensation for discrimination within the output transformer would not be effected. During the development of this unit, a tertiary feedback winding was checked, and it was found that a distinct phase shift occurred between the primary of the transformer and the tertiary winding. This latter winding was not always in-phase with either the secondary or the primary. Such a condition naturally results in feedback regeneration at some frequencies. This confirmed a long-standing theory that tertiary windings are not ideal for feedback purposes.

By slight adjustments of feedback resistors, they may be coupled directly to any one of the output taps, so that any varia-

ALL ABOUT FREQUENCY MODULATION

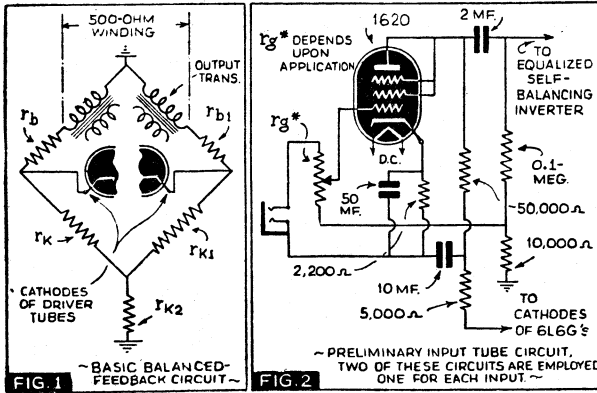

tions in the coefficient of coupling between the used output terminals and the 500-ohm line (if these terminals are not used), will not have any effect upon the desirable action of the feedback loop.

THE EQUALIZED SELF-BALANCING INVERTER

One of the major problems in developing an ideal inverter is to be able to obtain equal voltages (out-of-phase) from each side of the inverter output. Reasonable variations in tubes should not produce objectionable unbalance. A basic circuit for a popular self-balancing inverter is given in Fig. 6. In this circuit, balancing action is obtained by including a common grid-return resistor (r_{g2}) in the push-pull stage following the inverter. Balancing action for variation in the amplification factors of V1 and V2 is obtained by applying the differential voltage which appears across r_{g2} back to the grid of V2. While this action is very effective, it does not provide a perfect balance when V1 and V2 are reasonably matched. In fact, normal operation of this circuit provides an unbalanced signal at

the grids of the output tubes. While this unbalance may not be serious, it nevertheless, introduces distortion. To correct this condition, the equalized self-balancing circuit, illustrated in Fig. 7, was developed. In this circuit, a common plate load resistor is inserted in series with both plate loads of V1 and V2. Any unbalance in output voltage appears across r_2 and is coupled through condenser c_g to the grid of V2. If this unbalance is opposite in phase to the signal being impressed upon the grid of V2 through the dividing network r_g and r_{g1} , then degeneration takes place so as to decrease the output of V2, which in turn, equalizes the signals appearing on the grids of the output stage. On the other hand, if the residual voltage appearing across r_2 , is in-phase with the voltage being impressed to the grid of V2 through the dividing network r_g and r_{g1} , then, regenerative coupling takes place, to increase the output of V2. The great advantage of this equalized self-balancing inverter over the standard self-balancing inverter is that 100% balance is normally attained.

In order to ascertain the relative effectiveness of both circuits, the amplification

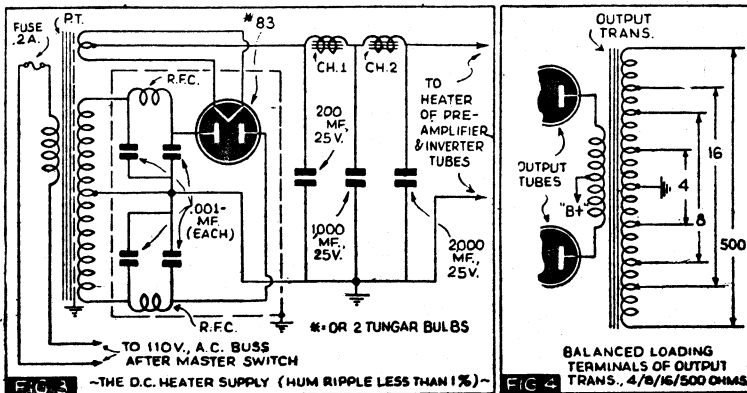

ALL ABOUT FREQUENCY MODULATION

factor of V2 was altered. In one case the output voltage of V2 was normally adjusted to produce twice that of V1, and in the other case, it was adjusted to produce one-half of V1. Both of these adjustments were made without either balancer in the circuit. Then both balancers were incorporated, and the following data tabulated: (In order to evaluate the effectiveness of the balancing actions, the percentage of unbalance is given under various conditions).

| Condition | Percentage of Unbalance at P.P. grids | |
|--------------------|---|---|
| | Self- balancing Inverter | Equalized Self- balancing Inverter |
| Balanced Tubes | 10% | Perfect balance |
| V2 Unbalanced +50% | 20% | 22.5% |
| V2 Unbalanced -50% | 9% | 11% |

It should be noted that while the standard self-balancing inverter provides a slightly better (by 2.5%) balancing action under widely unbalanced tube conditions, the equalized self-balancing inverter provides for better balancing under normal operating conditions. It should be remembered, that the data indicated, was obtained by unbalancing V2 50% in either direction. This represents a far greater change than ever encountered in actual experience.

SELECTION OF THE INPUT TUBES

As the input tubes and their associated circuits determine the residual noise level within the amplifier, it was decided to carefully check all prevailing tubes and standard circuits in an effort to attain a condition which would provide the highest gain-to-noise ratio.

In conducting these tests, a wide variety of tubes were set up in standardized circuits. Both the gain and their noise were measured under a wide range of operating conditions, so as to obtain the optimum gain-to-noise ratio. One of the preliminary acceptable circuits is given in Fig. 2. It will be noted that the type 1620 triple-grid amplifier tubes are used. It is not to be construed, however, that these are the only desirable tubes. As a matter of fact, a number of other types may be used, depending upon the ultimate application of the amplifier.

In checking residual noise, it was found that in many tubes, hum constituted a substantial portion of noise. By substituting a storage battery supply, many "hummy" tubes had their overall noise reduced from 8½ to 10 db. It was therefore decided that a D.C. supply would be incorporated within the amplifier to heat the preamplifier and inverter tubes.

THE D.C. HEATER SUPPLY

By connecting the 1620s in parallel, and then in series with the 6N7s, a 12-volt 600 ma. supply was required. Work done in our laboratory about 2 years ago, utilizing a type 83 to deliver 1A. at 24 V. proved the advisability of building an "A" supply around this tube. Our lab records had shown 1,000 hours' test without any measurable decrease in emission. The "A" supply rectifier system was therefore built around this type of tube circuit, which is illustrated in Fig. 3.

The writer feels that many readers will think that the 83 would be considerably over-worked in this circuit, in view of the fact that its published D.C. output current rating is 225 ma., maximum. Its peak plate current, however, it will be noted, is 675 milliamperes, maximum. This rating, though, is applicable to a 450-volt condition. It appears from empirical data, that when lower voltages are applied to the plates of the 83, such as 30 or 35 volts, a much higher current can be drawn, and still obtain reasonable life from the tube. A number of photocell exciter lamp supplies, incorporating four 83s and delivering 10 volts at 4 amperes, have proven the dependability of this type of circuit. For sceptical readers however, the amplifier can easily be redesigned to accommodate standard tungar bulbs in place of the 83 rectifier.

It will be noted that a pair of R.F. chokes and bypass condensers are employed in the filter circuit to avoid any disturbances from interfering with A.M. tuners, should they be used with this amplifier.

PLATE AND BIAS SUPPLIES

A study of the original power supply circuit will indicate that 2 rectifiers are employed in a tandem power supply circuit. A 5U4G supplies plate voltage to the drivers, preamplifiers, and inverter tubes, while a 5V4G supplies plate voltage to the power output stage. As a 5V4G is a slow-heating rectifier, plate voltage cannot be applied before the full bias appears at the control-grid of the output stage.

Thus by carefully designing the power transformer and its associated filter this circuit affords increased life of power output tubes as compared to circuits employing 2 rapid-heating or 2 slow-heating bias and plate supply rectifiers.

THE BALANCED OUTPUT CIRCUIT

Although the original circuit showed a balanced output transformer equipped with 4/8/500-ohm taps, this transformer can be supplied with any variation of impedances. It has been standardized, however, with 4/8/16/500-ohm windings. The balanced nature of the transformer provides a wide va-

ALL ABOUT FREQUENCY MODULATION

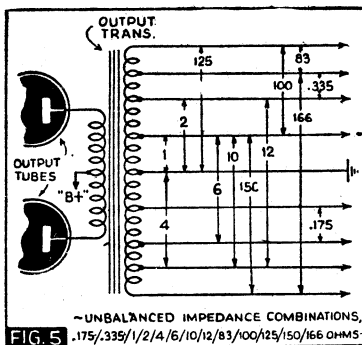

FIG. 5

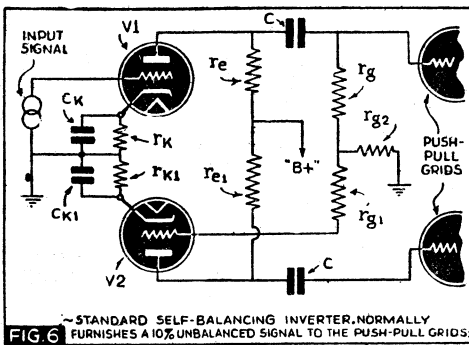

FIG. 6

riety of impedances, which are obtained either by balanced or unbalanced loading. A balanced loading circuit is illustrated in Fig. 4. Figure 5 shows the unbalanced output terminals available, ranging from 0.175-ohm to 166 ohms. It will be noted that a total of 16 impedance combinations are available, ranging from 0.175-ohm to 500 ohms.

Although the transformer may be loaded in an unbalanced fashion, true balanced feedback and push-pull action throughout the driver and power output stage still takes place. An analysis of the unbalanced loading circuit diagram, will clarify this point. Regardless of where the load is applied, the voltage from either terminal of the 500-ohm line to ground, would be identical. If any variation does exist, it would be caused by a difference in the coefficient of coupling from the loading portion of the secondary to the 500-ohm terminal on the same side. It is a relatively simple matter, however, to over-design the output transformer so as to provide a unity coefficient factor under any conditions of normal unbalanced loading.

POWER OUTPUT RATING OF THE AMPLIFIER

In rating the power output of an amplifier used for F.M. applications, the reader should dis-associate himself from conventional P.A. amplifier ratings, as unfair evaluation will take place, if this factor is not taken into consideration.

Ordinarily, a P.A. amplifier can safely be rated up to 5% or 7%. In most P.A. applications, this amount of distortion would not be readily detected. In F.M. work, however, it is imperative that the amplifier be operated at not more than a total of 1% distortion. This precaution must be taken, as originally outlined, to prevent the amplifier from becoming the bottle-neck of distortion in the entire F.M. transmission-reception chain.

Although the amplifier delivers a maximum output of 30 watts, it has been rated at 24 watts for 1% total harmonics. It is intended, however, to be normally operated

at an output level of 12 watts which provides less than $\frac{1}{2}$ of 1% total distortion. These unusually low ratings are advocated so as to virtually eliminate distortion considerations from the amplifier. It should be borne in mind, however, that if the unit is operated at an average level of 3 watts to produce unmeasurable harmonics, transient increases of level of 9 db. will bring the power output up to 24 watts with its intended 1% of total harmonics. Many so-called de-luxe F.M. radio receivers employ relatively low power output stages to effect appreciable economies, particularly when large quantities of receivers are involved.

WIDE-RANGE RESPONSE

The development of an amplifier having a response of from 13 to 30,000 cycles \pm 1 db., obviously increases its overall cost, and sometimes raises the question, "Why should I buy an amplifier with such a wide-range response, when F.M. broadcasts only run from 50 to 15,000 cycles? Furthermore, the average human being can not hear 30,000 cycles."

To answer this question intelligently, we must first acknowledge the fact that the latest findings amongst young listeners with acute hearing clearly indicate that 30,000 cycles CAN be perceived! Furthermore, fundamentals and sub-fundamentals, should be reproduced, in order to avoid destruction of original tone qualities. This can easily be proven by a difference in quality of response of bass drums or organ programs when fundamentals are cut off. In view of the fact that the response range of amplifiers has been continually increasing the writer believes that it is only a question of time before the ultimate amplifier will extend out to the outermost limits of human hearing, and, if this can be accomplished now, why shouldn't the amplifier be removed as a restricting link in the chain of reproduction?

We note that in the past, loudspeaker manufacturers have consoled themselves for

ALL ABOUT FREQUENCY MODULATION

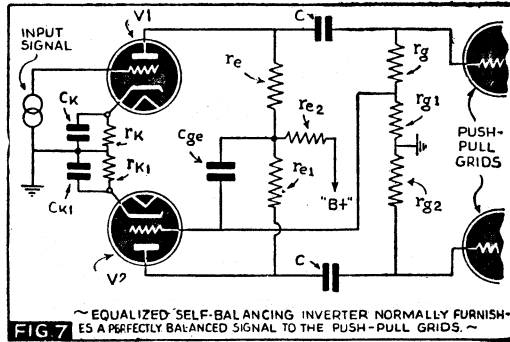

restricted response by contending that no "program or amplifier can reproduce more than 5,000 cycles." Record manufacturers complained that no phono pickup could reproduce more than 6,000 cycles, and pickup manufacturers contended that no amplifier passed more than 8,000 cycles. This vicious circle naturally hindered projected improvements in any one branch.

These illogical assumptions really have no place in modern communication equipment. If F.M. stations are forced by the F.C.C. to provide 50 to 15,000 cycles, the writer believes it is only a question of time before this spectrum will be balanced* and some of the better stations will eventually extend this range to the very outer limits of human hearing.

In providing this extremely wide range within the present amplifier, any possibility of early obsolescence is completely eliminated, for further extension of the range is obviously unnecessary, unless the human race during the process of evolution will acquire an extended hearing range.

* See "Balanced Audio Spectrums," *Radio-Craft*, September, 1940. Page 164.

CONCLUSION

The writer wishes to caution readers not to compare this amplifier with conventional public address units, by checking power output, distortion, hum, or tube components, as a number of essential features have been included in its design, which are highly desirable, in order to attain the full benefits from F.M. broadcasting.

Because of its technical excellence, it can of course, be used in any other application requiring the ultimate in design and performance.

Additional information on the currents and voltages at the outputs of the high-voltage and bias supplies of the F. M. Audio Amplifier are described here.

The normal D. C. out of the 5V4G's filter system (high-voltage supply) is 160 ma. at 590 V. (to ground.) Normal D. C. out of the 5U4G's filter system (bias supply) is 22 ma. at 185 V. (to ground).

CHAPTER IV

F. M. SERVICE

PART I

Antenna Installation and Service

THE advent and increasing popularity of Frequency Modulation receivers have presented new problems to the radio technician. Frequency Modulated receivers require installation and service adjustments somewhat different from standard procedures. Knowledge of these differences is *essential* to develop and apply these new techniques.

From a standpoint of design and circuit arrangement, F.M. receivers are similar to those with which we are already familiar. It is the fact that F.M. receivers operate on ultra-highfrequencies, that new considerations are introduced, considerations involving antenna installation, receiver alignment, oscillator stability, and insulation leakage. To facilitate discussion of the subject, the material herein is presented in 2 installments, Part I—Antenna Installation and Service, and, Part II—Receiver Service.

RECEPTION CONDITIONS ON F.M. BAND

To understand and appreciate the importance of a suitable antenna and its proper installation, a brief explanation of transmission and reception conditions on the 42-50 megacycle band is of consequence.

The strength or signal level and distance over which signals are received at the antenna depends upon several factors: power of transmitter, location and type of antenna, time of day and season of year. The theory of radio wave propagation most generally accepted is that advanced by Professors Kennelley and Heaviside, in which 2 radio waves are radiated from a transmitting antenna, (a) the *ground* or *surface* wave, and (b) the *sky* wave.

The surface wave follows the curvature of the earth and is absorbed by the earth, metallic deposits, steel buildings, hills, trees, and bodies of water. However, the surface wave is steady and reliable in that it

travels an equal distance both day and night. When waves of a high frequency are transmitted, less of the radiated energy is transformed into surface waves (possibly because it is absorbed faster by the earth) and more of the energy is changed into the sky wave. This latter wave does not follow the surface of the earth, but travels in straight lines and behaves much like light and radiant-heat waves.

The sky waves travel out from the earth in all directions and are thought to encounter layers of ionized gas in the earth's atmosphere or ionosphere. These layers of gas reflect and bend a portion of the sky wave back to earth, so that signals may be received at considerable distances far beyond the range of the surface wave. Part of the sky wave is also absorbed or passes directly through into the ionosphere. The amount of reflection and absorption of the sky wave is dependent upon the density and ionization of the gas layers, caused by ultra-violet radiation from the sun, which ionizes the gas molecules and produces free electrons. Since the degree of radiation from the sun and its influence is a variable factor changing with the time of day and season, the density and height of the "Heaviside Layer" above the earth is altered. For this reason, the amount of energy reflected or refracted to earth and the angle to which the waves are bent is likewise a variable factor.

The degree of reflection of the sky wave also depends upon the frequency. The higher the frequency of a propagated radio wave, the farther it penetrates the ionosphere and the less it tends to be bent and reflected to earth. At frequencies as high as 42-50 megacycles, the F.M. transmission band in which we are interested, radio waves are bent so slightly that they seldom return to earth.

Thus, it can be seen that reliable, consistent, and dependable reception of signals

ALL ABOUT FREQUENCY MODULATION

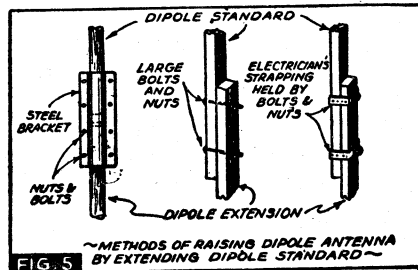
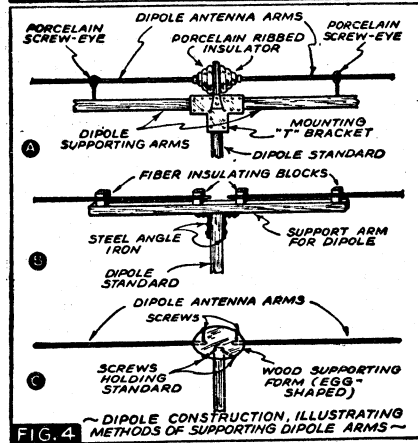
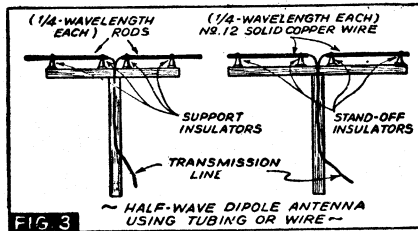
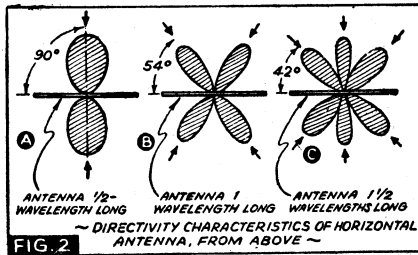
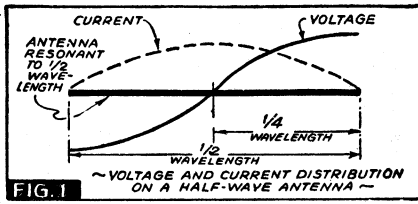

in the F.M. band during both day and night, because of their ultra-highfrequency nature, is limited to the surface wave, or line-of-sight propagation. For all practical purposes, the surface waves may be likened to beams of light traveling straight out from the transmitting antenna to the horizon and beyond into space. To receive these waves, the receiving antenna must be within "seeing" distance of the transmitter. The greater the height of the transmitting and receiving antennas, the greater the horizon range or area over which dependable signals may be received. Although reception of ultra-highfrequencies beyond the horizon range of a transmitter is not impossible and is frequently reported, strength of signals is not constant, and thus unreliable.

F.M. ANTENNA REQUIREMENTS

Probably the 2 greatest advantages possessed by F.M. receivers, when compared with those of conventional standard design or amplitude modulated receivers, are (1) substantial freedom from natural static and "man-made" interference, and (2) extended fidelity and dynamic range of reproduction. Most listeners are more concerned with these aspects of F.M. receiver superiority than with other claims. To derive these benefits, only one requirement must be satisfied, that of adequate signal pick-up, to operate the limiter stage of the receiver. Without sufficient signal to saturate the limiter tube, elimination or clipping of signal peaks will be incomplete, and reception will be generally unsatisfactory, as a result of noise amplification and distortion.

To assure adequate signal pick-up, attention must be directed to the antenna system. Of all factors contributing to strong signal pick-up of F.M. signals, antenna height is the most important. Hundreds of tests have proven conclusively that the strength of the signal picked-up by the receiving antenna is almost directly proportional to the height of an antenna. For example, by doubling the height of an antenna, an increase of 100% in signal level is secured. For every foot the antenna is raised, a proportionate gain results. Of course, there must be a substantial increase in antenna height before a real improvement is noted.

Although the F.M. receiver provides noise reduction by reason of its limiter stage, the range over which the limiter operates is necessarily restricted. For this reason, every precaution and device must be employed to reduce, as much as possible, all noise pick-up by the antenna system. The principal sources of interference are diathermy and X-ray machines, automotive ignition, sign flashers, neon signs, oil burners, high-voltage power transmission lines, electric lighting and power plants, and all electrical

ALL ABOUT FREQUENCY MODULATION

apparatus of a high-frequency nature. This interference may be picked up by both direct and indirect radiation.

Locating the aerial in a noise-free area and utilizing a balanced transmission line to conduct signal voltage to the receiver, is the general approach toward solution of this problem. Increasing the height of the antenna not only serves to increase the signal strength, but aids in lowering the noise level.

LOSSES

At ultra-highfrequencies, the matter of insulation is of considerable importance. Materials such as unglazed porcelain and molded bakelite, which are satisfactory at powerline and broadcast frequencies, are relatively unfit at U.-H.F. because of losses resulting from high power factor and absorption. This is particularly true of the cheap rubber, impregnated-cotton insulated twisted-pair wire so often mistakenly used for transmission lines. Only insulated wire, insulators, terminals, and terminal blocks of the highest quality should be countenanced in the installation of an F.M. antenna to avoid all possible losses and consequent reduction in signal strength.

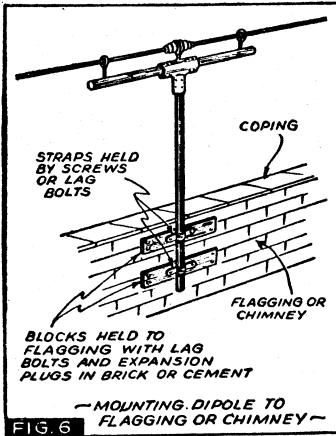

Fortunately, the current and voltage distribution on a half-wave doublet or dipole antenna, which is the most effective and popular type employed for F.M. reception, is such that the voltage at the center of the dipole is theoretically zero. This is shown at Fig. 1. For this reason, and since the 2 sections of the antenna are generally supported at the center, it is not absolutely essential that extremely-low-loss insulators or supports be used for this purpose.

Losses in a twisted-pair transmission line may be high due to high carbon content of the rubber insulation, and absorption of

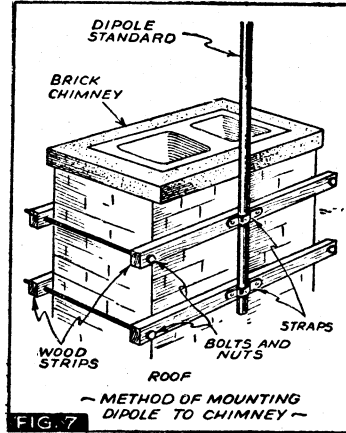

moisture by outer cotton insulation. Only lines that are sufficiently weather-proofed and storm-proofed, and use a high grade of rubber, are acceptable. Ordinary lamp cord is definitely "out" because of lack of weather-proofing. Some manufacturers supply transmission line cable especially suitable for F.M., with a high percentage pure latex rubber insulation on each wire and an outer covering of the same material. Where transmission lines must be run distances exceeding 200 feet, losses become prohibitively high. In such cases, concentric or coaxial line cables are desirable and essential. Concentric cables consist of a solid or stranded conductor, rubber insulated, enclosed in a copper braided shield, with over-all weather-proofed cotton insulation. Coaxial cable is similar with the exception that insulated beads or spacers are used to maintain a fixed clearance between the solid conductor and conducting shield. Of the two, coaxial cable possesses lower losses per foot, but is decidedly more expensive.

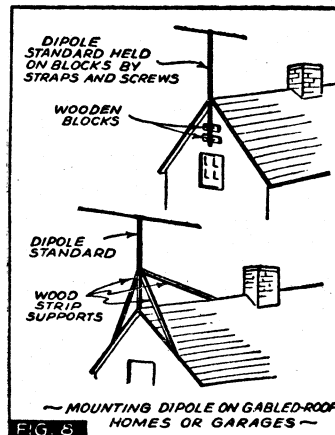

ALL ABOUT FREQUENCY MODULATION

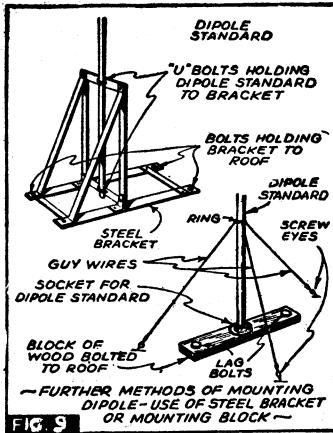

IMPEDANCE MATCHING

When a manufacturer's antenna kit is used, the question of *impedance matching* usually presents no problem, since these kits are available complete with dipole, transmission line, insulators, and matching transformer. The importance of impedance matching between dipole, transmission line and receiver input cannot be over-emphasized. The advantages gained by locating the antenna high in a clear area may be minimized through losses resulting from mismatch.

The impedance at the center of a half-wave antenna in free space is 73 ohms. However, because of the presence of insulators and dielectric material in the vicinity of the antenna, and the height of the antenna above a conducting ground as well as the efficiency of the ground, this value is altered considerably. As a result of these factors, the impedance of the average half-wave antenna may be taken at approximately 100 ohms.

The surge impedance per unit of length of a transmission line consisting of 2 parallel conductors, depends upon the size and spacing of the conductors, and the dielectric constant of the insulation between the conductors. The larger the conductor and the closer the spacing, the lower is the surge impedance. For example, the impedance of a twisted-pair line consisting of No. 14 rubber-covered, cotton-braid insulated wire, similar to that used in house wiring, is approximately 100 ohms. This type of wire, when suitably weather-proofed and connected to obtain an impedance match in a manner to be described later, may be used as a short transmission line. In any event, to obtain the greatest transfer of energy from the dipole to receiver, a line of the correct impedance must be employed. Transmission line of the twisted-pair, concentric and coaxial type, of various stated surge

impedances, are commercially available from large supply sources.

Of equal importance in the matter of impedance matching is that of terminating the transmission line in the correct characteristic impedance. By this is meant that the impedance of the receiver input must match that of the transmission line. Most receivers are designed with antenna inputs whose impedance varies from 100 to 300 ohms, necessitating the use of an impedance matching device in some cases to obtain maximum performance. A description of a simple auto-transformer to serve this purpose is later given.

Because of the short physical length of an F.M. half-wave antenna, and character of the transmission line, swaying in the wind may produce signal variations and noise level changes of large magnitude, sufficiently great to place these variations beyond the control of the leveling action of the limiter stage in the receiver. For this reason, the antenna and transmission line must be rigidly mounted, by whichever means are available and necessary, to prevent possible signal voltage changes and distortion as a result of reception of out-of-phase signals.

POLARIZATION

Most F.M. transmitters employ antennas which are in a horizontal plane and radiate energy which is *horizontally polarized*. To receive this signal, the receiving antenna must also be horizontally polarized to have a maximum voltage induced in it. Some few stations employ *vertical polarization*, thus making a vertical receiving antenna necessary for maximum performance.

The horizontally polarized half-wave antenna is more widely used because of an advantage insofar as noise pick-up is concerned. Since noise originates from nearby sources, and a good part of it, especially automotive ignition interference, is vertically polarized, less of this noise voltage is induced in a horizontally polarized antenna than in one that is vertically polarized.

On the other hand, the horizontal half-wave antenna is directional, the greatest signal voltage being induced when the length of the antenna is placed in a position which is broadside or at right-angles to the signal source.

Antenna polarization is important at distances relatively close to the transmitter. At farther distances, the plane of polarization of U.-H.F. waves has been known to change as much as 90°, so that correct polarization becomes a matter of experimentation to provide best signal pick-up. Tilting the dipole at various angles from the horizontal to the vertical position, and checking receiver response to these changes, will determine which position is best. When an antenna for an F.M. receiver is installed

ALL ABOUT FREQUENCY MODULATION

in areas close to several transmitters, one of which may radiate vertically polarized waves, it may be necessary to utilize both a vertical and horizontal dipole to receive all signals with sufficient signal strength. Or a compromise may be effected whereby one dipole is used at some angle between a horizontal and vertical plane.

A resonant antenna, such as the half-wave dipole, possesses marked frequency discrimination by which signals at other than the resonant frequency of the antenna are sharply attenuated. Since the F.M. band of transmission covers a wide range of frequencies, from 42-50 megacycles, this frequency discrimination would prove undesirable were it not for the fact that the loading of the transmission line produces a broad frequency response. It is customary therefore to cut or design the half-wave antenna to resonate at the center of the F.M. band, at approximately 46 megacycles. It may be advisable, inasmuch as line losses increase with an increase in frequency, to resonate the antenna at 47, or possibly 48 megacycles to compensate for these losses.

DIRECTIVITY

Because of the fact that the horizontal half-wave antenna is bi-directional, this discrimination may prove undesirable when the signals of widely separated transmitters must be received at one location. The directional characteristic of a horizontal half-wave antenna is illustrated in A of Fig. 2.

As a general rule, this situation proves troublesome in urban areas or close to a number of transmitters which lie in various directions, one or more of which may be outside the directional pattern of the antenna. No such problem is presented when the receiver is far removed from this area. As a matter of fact, in the latter instance, attempts are usually made to increase the directivity of the horizontal antenna. One solution to this bi-directional effect is through the use of a vertical half-wave antenna, but this results in a loss of signal strength and an increase in noise pick-up. In some cases, an antenna designed to resonate at a frequency equal to twice or 3 times a half-wavelength, is employed to overcome the bi-directional effect of a horizontal half-wave antenna. The changes in the directional pattern from that of a half-wave are shown at B and C of Fig. 2.

It can be seen that the angle of the null points is decreased thus producing less directional effects, but the maximum signal voltage possible to be induced into the antenna are also less. In addition, the resistance of such an antenna increases considerably, from 25 to 35%, necessitating a transmission line of higher impedance and further impedance matching at the receiver. Another method is that of orientating the horizontal half-wave antenna in some com-

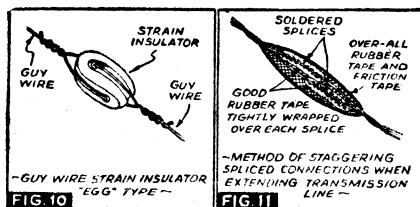

promise position, whereby adequate signal pick-up is obtained in all directions.

As mentioned previously, the half-wave dipole antenna is usually designed to resonate at a frequency in the center of the F.M. band. When calculating the length of a half-wave antenna, it must be remembered that the physical length usually averages 5% less than the electrical length. This is due to *end effects* occasioned by the presence of insulators, and the fact that the antenna has resistance. A simple conversion formula, which considers these end and resistive effects, for computing the physical length of a half-wave antenna, is the factor 467.4 or 468 (which is accurate enough), divided by the desired resonant frequency of the antenna. The figure obtained is the length of the entire antenna in feet. Each half of the dipole or doublet should therefore be cut to half this amount. An antenna with each half of the dipole cut to 5 feet, 1 inch, has been found satisfactory for the reception of signals in the F.M. band.

F.M. ANTENNA TYPES AND INSTALLATION

At locations close to F.M. transmitters and where the problem of adequate signal pick-up and noise pick-up does not exist, any short length of wire will serve as the F.M. antenna. When operating conditions are favorable, an ordinary inverted-L type antenna of 20-100 feet will provide satisfactory reception of F.M. signals. Upon several occasions, an antenna comprising a 20-foot length of wire extending downward from a window was found sufficient to obtain good reception on an F.M. receiver located 25 miles from a number of transmitters. Operating conditions were ideal, however, the noise level being particularly low with the receiver in a home built on a hill with a good line-of-sight. The distance from a transmitter that such an antenna, or one of the inverted-L variety, will provide a signal of sufficient intensity and high signal-to-noise ratio, is a matter of conjecture and must be left to trial. In most instances, an antenna efficient at U.-H.F. must be installed.

The most satisfactory antenna for F.M. reception is the horizontal half-wave dipole. Essentially, this antenna consists of 2 metal-tubular rods or wires placed in line with each other, as shown in Fig. 3. The metal rods may be either copper or aluminum. Solid rods are not recommended. To

ALL ABOUT FREQUENCY MODULATION

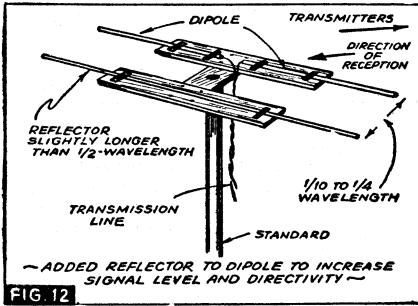

obtain the requisite rigidity, only wire of a heavy gauge, either No. 10 or No. 12, should be used, supported by low-loss insulators. The transmission line must be run at right-angles to the dipole for at least a $\frac{1}{4}$ -wavelength, at least 5 feet, before any bends in the line are made.

ROOF MOUNTINGS

Various methods have been devised to support the dipole arms. These are merely mechanical arrangements and usually have no bearing upon electrical efficiency. The only requirement is substantial construction. Several of these arrangements are shown in Fig. 4.

At A, a 2-piece cast aluminum bracket assembled by means of a number of bolts and nuts, is used to couple the 2 dipole supporting arms and standard. A center supporting insulator of ribbed construction is bolted to the bracket. Glazed porcelain screw-eye insulators serve to support the dipole rods at the far end of the supporting arms. The rods are threaded onto screws emerging from each end of the center supporting insulator. The transmission line is connected to these screws internally. Laminated fibre or hardrubber blocks are used to anchor the dipole rods in position in the arrangement illustrated at B; and, an egg-shaped wood form is employed for the same purpose at C.

In manufactured kits, the standards are supplied in 5 to 6 foot lengths of straight-grained knot-free material, and more than one is used to elevate the dipole as high as possible. These sections are joined by means of a 2-piece sheet-iron or cast-aluminum bracket held by bolts and nuts, screws, and electricians' strap, as shown in Fig. 5.

Methods of anchoring and supporting the antenna vary in each individual case. Generous use is made of expansion plugs, lag bolts, and electricians' strap.

On apartment buildings and private homes, the dipole may be erected as in Fig. 6. The wood blocks are held in position with lag bolts which are fastened in expansion plugs snugly fitted into holes or openings in

the brick, stone, or cement, made by a "star" drill and hammer. The standard for the dipole is mounted by straps and lag bolts. When brick or stone chimneys serve as the "foundation" for the antenna, it is essential that the construction be solid and substantial. Too often, loose bricks and cement prevent firm insertion of the expansion plugs. Also, use of the hammer and "star" drill may dislodge bricks and cement and so weaken the chimney that solid anchoring of the antenna is impossible. The dangers of a weak chimney further burdened by the weight and stress of an antenna in the wind are apparent. When such chimneys offer the only available means of support for the antenna, the construction shown in Fig. 7 has proved safe and substantial, provided suitable guys are employed. It may be seen that 4 lengths of 2 x 4 in. or 2 x 3 in. lumber are held in position by long bolts and nuts. These bolts are procurable from large hardware supply stores or may be ordered from the local blacksmith or iron-works. The dipole standard is held erect by straps and lag bolts.

The problem of installing the dipole on homes with peaked sloping roofs often presents itself. When access to the chimney may be gained without danger of slipping or falling, the construction already shown in Fig. 7 is recommended. Alternative methods of mounting the dipole are illustrated in Fig. 8. When the eaves of the building do not jut out beyond the vertical side walls, the standard of the dipole may be secured directly to the wall. Otherwise, it is necessary to build up or pile up a sufficient number of wood blocks, securely fastened to the wall and to one another, so that the standard may clear the eaves and be erected vertically.

Another method of installing the dipole employs a steel bracket or wood block which serves as the base for the dipole. This is shown at Fig. 9. The bracket is bolted to the roof and the dipole standard held to steel cross-bars by means of threaded U-bolts. The wood block which is a 12-18 ft. length of 2 x 4 in. lumber, is bolted to the roof. The dipole is mounted in a hole or socket made in the wood block. In the latter method, guy wires are absolutely essential, since this is the only means of holding the dipole erect and steady. The methods and manner of erecting the dipole antenna herein described are by no means the only possible arrangements. Others will suggest themselves.

TOWERS

Dipoles which "tower" or rise more than 5 ft. into the air usually must be supported rigidly to prevent swaying. This is done not only to assure good reception but to prevent weakening of supports and excessive strain-

ALL ABOUT FREQUENCY MODULATION

ing of mooring bolts and plugs. For use as guy and supporting wires, No. 10 solid or stranded galvanized-wire "rope" should always be employed to effect a "permanent" installation.

Anchoring of the guy wires may take any number of means. Probably the simplest of all methods is the use of large eye-screws fastened securely to any solid wood mooring or to expansion plugs inserted into brick walls. Turnbuckles should be employed to take up the slack in long cables when the wires cannot be tightened otherwise by hand. Of particular importance at this point is the necessity of breaking up the guy wires by insertion of strain insulators of the "egg" variety to avoid possible resonance effects at the receiving frequency. For our purpose, guy-wire lengths should always be less than 10 feet. This is illustrated at Fig. 10. Although any system which will support the dipole is suitable, the 3-guy-wire arrangement has proved most satisfactory. In any event, the guy wires must be kept out of the field of the dipole.

The generous use of tar compounds and synthetic resins is recommended for weather-proofing lag bolts, straps, supports and dipole standards. When a steel or wood base assembly is bolted to the roof, application of a tar compound is essential to avoid leaks and seepage in inclement weather. This material is available from many supply sources.

TRANSMISSION LINE

The transmission line must be run at right-angles to the dipole for at least 5 ft. Avoid right-angle or all unnecessary bends, and doubling back of the transmission line. Tape up the line where the insulation is slit to make connection to the antenna to prevent entrance of moisture. Although it is best to keep the transmission line in one piece from antenna to receiver, when it is necessary to extend the line, solder and tape the lengths of line, but stagger the connections as shown in Fig. 11. Only high-grade rubber tape may be used at any point in an F.M. installation. Ordinary friction tape introduces high losses at ultra-high-frequencies. Every means must be employed to reduce this possibility of leakage.

Anchoring of the transmission line should be accomplished without danger of snapping. Protect the line from abrasion at all points of contact. Use standoff insulators wherever possible to keep the line clear. Insulators of the "nail-it" knob type should be avoided, since with these there is danger of bruising the insulation of the line. The transmission line may be brought into the building in various manners. The porcelain "feed-through" insulator is practical. When a hole is drilled in the window casement or frame for the line or feed insulator, it should be drilled downward from inside of building to

prevent entrance of moisture. The use of the common lead-in strip should also be avoided as the insulation is usually inadequate and necessitates a break in the transmission line.

Lightning protection and installation as prescribed by National and local Boards of Fire Underwriters, and in accordance with local fire and building department codes, are essential. Technicians should familiarize themselves with these regulations, such as, height of antenna above building, type of lightning arrester and type of ground.

The ground connection for the receiver is important. Although in A.C.-operated receivers, the "ground" is obtained through the line bypass condenser or capacity of the power transformer windings, reliance upon this grounding effect is not advised. Addition of a good ground connection often spells the difference between good satisfactory reception and noisy operation.

ANTENNA SERVICE POINTERS

After the F.M. installation is complete and reception is found satisfactory, no further thought of F.M. antenna requirements is necessary. When operation of the receiver is generally poor and it is known that the receiver is not at fault at the time of installation, we must look to the antenna installation.

The cause for unsatisfactory F.M. reception may be attributed to many factors: inadequate signal pick-up, excessive noise pick-up, incorrect polarization and directivity of dipole, and losses due to impedance mismatch and poor insulation, any or all of which tend to produce weak, noisy and distorted reception.

In areas close to transmitters, the question of adequate signal pick-up does not exist. At remote locations, this consideration is of importance. It is assumed that the dipole was erected as high as possible in the first place. The method generally employed to increase signal pick-up in this case is by the use of a *reflector*.

This is a metal rod, similar to that of the dipole itself, but slightly longer, placed parallel with the dipole from 2 to 5 feet behind it, as shown in Fig. 12. This procedure not only greatly increases signal pick-up from one direction, but increases the directivity of the antenna, since signals approaching from the rear are greatly attenuated. This latter result is especially advantageous when it is desired to reduce noise pick-up from a nearby source. The reflector is used just as often to obtain this effect as to increase signal level. No electrical connection exists between dipole and reflector. In instances where it is necessary to obtain a further increase in signal strength, a *director* is used.

The director is a metal rod slightly smaller in length than the dipole, and placed about 2 to 5 ft. in front of the dipole. This

ALL ABOUT FREQUENCY MODULATION

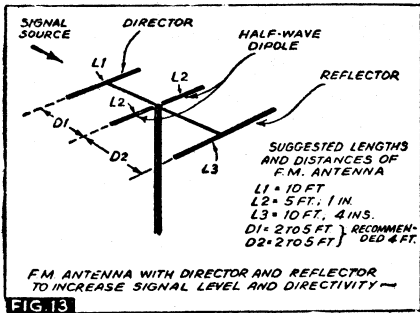

is shown in Fig. 13. Approximate lengths and distances are given.

Before installing a reflector and then a director, it is common practice to rotate the dipole to change its directivity, although it may have been positioned properly (at right-angles) with respect to the transmitter, in order to increase signal pick-up.

INTERPHONE

When 2 men are engaged in the installation of the antenna, a telephone or other means of communication may be rigged up, so that the effect of rotating the antenna to various positions upon reception at the receiver may be ascertained. On a 1-man job, this is more difficult, since checking receiver response to the change in direction must be made after each change. The directivity of a horizontal half-wave antenna is critical, depending upon the distance from the transmitter. Directional changes of only a few degrees are often sufficient to affect signal strength considerably. These facts apply also to polarization of the antenna. The tilted position at which a stronger signal may be received must be checked after each change in polarization, but these changes are not critical.

When a transmission line is used to couple the dipole antenna to the receiver, loss in signal strength is possible due to impedance mismatch, when the surge impedance of the line is not nearly that of the antenna. The loss due to mismatch often has been found to lie with the use of a transmission line whose impedance was higher than that of the antenna. To correct this condition, the ends of the transmission line, where they connect to the dipole, may be fanned out, as shown in Fig. 14. This is possible since the impedance of a half-wave antenna, which is at a minimum at the center, increases toward the outside ends. The distance of the fanned portion of the line from the inside ends of the dipole depends upon the line impedance. It is necessary, therefore, to fan the leads out a little at a time, noting the effects upon reception, until a point is found on the antenna which matches the line impedance. This point of

connection will provide maximum signal voltage transfer.

MATCHING TRANSFORMER

Another cause for loss in signal level is due to mismatch between the transmission line and the receiver input circuit. One method used to effect correct matching of the 2 impedances at this point is through the use of a matching transformer or autotransformer. The construction of such device is relatively simple.

A total of 28 turns of No. 18 enamel- or cotton-insulated wire is wound on a 1-in. form, and tapped every 2nd turn. The center-tap or 14th turn is grounded to the receiver. Referring to all taps with respect to the center-tap, there are 7 pairs of taps which connect to an equal number of turns on the coil. In other words, taps No. 1 are each 2 turns from center-tap, taps No. 2 are both 4 turns from center-tap, etc. By suitably connecting the transmission line and the balanced receiver input to the coupling coil, a correct impedance step-up or step-down match may be obtained.

When the transmission line is of lower impedance than the receiver input, it may be connected across a fewer number of turns than the number across which the receiver input is connected, to provide the step-up ratio. When the line impedance is higher than that of the receiver input, the receiver input is connected across fewer turns than the line. Once the correct impedance ratio is found, the coil may be enclosed in a suitable shield and all leads soldered to the correct taps. The nature of the autotransformer requires a balanced receiver input, wherein neither end of the primary of the antenna coil is grounded. Lack of this balanced condition will unbalance the transmission line and introduce undesirable effects. Fortunately, almost all F.M. receivers have this balanced input.

Poor F.M. reception may be the result of a high noise level, despite adequate signal pick-up. In such cases, it is assumed that the dipole has been erected high in a noise-free zone and a balanced twisted-pair transmission line has been used to connect the dipole to the receiver. Unless the receiver has a balanced input, the advantage or purpose in using a balanced line is lost, and noise voltages induced into the transmission line may be induced into the antenna coil of the receiver. Because the conductors in a twisted-pair line are close, any voltage induced in them, whether it be signal or noise voltage, will be equal and in-phase with each other so that their polarities are always similar. Consequently, the polarity of the ends of the line which connect to the primary of the receiver input transformer are both either positive or negative.

ALL ABOUT FREQUENCY MODULATION

Therefore, no current will flow in the coil since there is no difference of potential, and no noise voltage will be induced because of this inductive relationship. However, some noise voltage is always transferred to the receiver because of capacitive coupling between primary and secondary of the antenna coil.

REDUCING CAPACITY COUPLING

Two methods may be employed to reduce this capacity coupling. One involves the use of an auxiliary transformer in which a grounded Faraday electrostatic shield is interposed between primary and secondary windings of the transformer. This transformer is connected between the transmission line and the receiver, and it is unimportant whether one side of the receiver input is grounded or not. The second method, and one which has been employed with success is the use of a center-tapped coil, such as the impedance matching autotransformer described, connected between the transmission line and receiver. The center-tap of the coil is grounded. The pair of taps to which the receiver input and lines are connected is best determined by trial. In any event the receiver input must be balanced or ungrounded.

Probably the most frequent cause for low signal pick-up is the unwarranted use of transmission line with low-grade rubber insulation. The losses and leakage at U.-H.F. of this type of wire are great enough to practically short-circuit the line and therefore the signal voltage. The use of line with good rubber insulation *must* be stressed. Generally, transmission line rubber insulation which possesses good elasticity and standing "plenty of stretch," may be considered "live" enough for use as a line

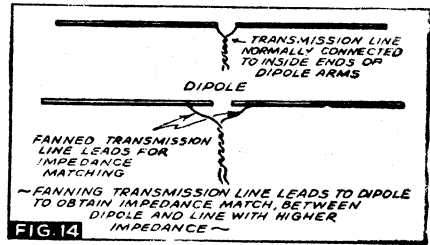

in an ultra-highfrequency antenna system. Wire with rubber insulation which can be torn or peeled easily without stretching is "dead" rubber and usually presents high losses.

Although there is no doubt that the comparative bulk of good transmission line is unsightly from an artistic point of view when used in the interior of a building, twisted or parallel lamp cord, which is certainly more appealing, should never be used to continue the transmission line from the window to the receiver. Ordinary twin lamp-cord conductor offers high losses at F.M. frequencies.

There is much to be written of F.M. installation and service, more than space limitations will permit, but an effort has been made to include most essential requirements and considerations. To sum up briefly, the F.M. antenna system should possess the following characteristics:

- (1) Dipole as high as possible.
- (2) Good low-loss insulation.
- (3) High-grade transmission line.
- (4) Proper directivity and polarization.
- (5) Correct impedance matching.
- (6) Balanced line and receiver input.

RECEIVER ALIGNMENT AND DIAGNOSIS

IN servicing Frequency Modulation receivers, knowledge of the fundamental operating differences between Amplitude Modulation and Frequency Modulation receivers is essential. The subject of *F.M. antenna and installation* was covered as completely as space limitations would permit, in Part I of this discussion on F.M. Installation and Service. It is the purpose of this article (Part II) to discuss *F.M. receiver service requirements and procedures*. We will start off with a brief résumé of *First Principles* and then launch into our discussion of practical F.M.-receiver servicing.

Frequency-modulated signals are obtained by varying the frequency of the carrier signal at an audio or sound frequency rate. The amount the carrier frequency is varied on both sides of the mean or carrier frequency determines the intensity or volume level of the signal. Basically, the F.M. receiver is similar to the A.M. superheterodyne receiver except for 3 major differences. This may be seen in the block diagram of the 2 receiver types pictured in Fig. 1. Both types may have an R.F. stage, the primary intention of which is to provide adequate selectivity and voltage gain. A converter stage, consisting of a single tube functioning as mixer and oscillator, or 2 separate tubes performing these functions is common to both.

THE I.F. AMPLIFIER

Although an I.F. amplifier of one or more stages is also common to each receiver, the I.F. amplifier in an F.M. receiver differs from that of an A.M. receiver by reason of its wide-band characteristics. In an A.M. receiver, the I.F. amplifier is designed to reject a signal more than 10 kc. to 15 kc. from that to which the amplifier is tuned. On the other hand, the I.F. amplifier in an F.M. receiver is designed to pass a signal, without appreciable attenuation, as much as 100 kc. either side of the frequency to which the I.F. transformers are aligned.

Various means are utilized to secure this band-width. In some instances, the primary and secondary windings are over-coupled to broaden-out the response curve. The

General Electric HM 136 receiver and the more recent Pilot FM-12 receivers are examples of this practice.

The majority of F.M. receivers, however, employ shunt resistors, to load up either or both the primary and secondary windings to obtain the required 150 kc. to 200 kc. band-width. The use of such high-gain tubes as the 1852, 1853, 7G7, and 7V7, more than offsets the loss in gain as a result of resistive loading. In the early Pilot FM-12 model, as well as several F.M. adapters, both primary and secondary of the I.F. transformers are shunted by resistors, as shown in Fig. 2. Only the secondary winding of the I.F. transformers in almost all Stromberg-Carlson F.M. receivers, is shunted resistively. The value of these shunt resistors varies with each receiver model, and depends upon transformer design and degree of loading required in each case to secure the band-spread. Resistor values from 10,000 ohms to 50,000 ohms are most commonly used for this purpose.

Early-model F.M. receivers employed an I.F. amplifier tuned to 2.1 megacycles, with a few using 3 mc. Modern F.M. receivers have I.F. amplifiers aligned to 4.3 mc., the standard set down by the Radio Manufacturers Association (R.M.A.). One model manufactured by Zenith has an 8.6 mc. I.F. amplifier.

THE LIMITER

In the block diagram for an F.M. receiver, a limiter stage may be seen. The limiter stage, essentially an I.F. stage, consists of 1 or 2 amplifier tubes so arranged as to deliver constant output despite wide variations in signal input. The tubes employed as limiters are usually pentodes having sharp cut-off characteristics, and operated at low plate and screen-voltages, so that plate current cut-off occurs with relatively small grid bias or signal input.

Normal signal input will swing the grid voltage considerably above and below the linear portion of the tube's characteristic curve. Positive peaks beyond the range of the limiter tube will be clipped by grid-bias limiting, whereas negative signal peaks will be clipped due to plate current cut-off. In

ALL ABOUT FREQUENCY MODULATION

this way, variations in signal voltage delivered to the limiter which are greater than the operating limits of the tube are clipped and have no effect upon plate current.

Since static and noise disturbances, primarily, produce amplitude changes in the signal, as do tube noises, the clipping of the amplitude changes removes the disturbing effects but leaves the frequency-modulated signal unaltered. This action is illustrated at Fig. 3. For complete noise-elimination, it is essential that the signal voltage appearing at the limiter grid be sufficiently great to swing the grid bias to plate current cut-off and saturation points.

Limiter tubes are generally operated at zero bias or with a small bias voltage. The limiter circuit utilized by Stromberg-Carlson, shown at Fig. 4, is representative of many F.M. receivers. The circuit of the General Electric H.M. 136 receiver, at Fig. 5, typifies another method wherein the load resistance is connected in the secondary-return. In this case, the tube is supplied with a small initial negative bias. In the Pilot FM-12 receiver, a low-value resistor is connected in series with the limiter load resistor shown at Fig. 6, so that an indicating meter may be conveniently connected to the receiver for alignment purposes. An example of 2 tubes arranged in cascade or series to operate as more effective limiters is seen in the General Electric JFM 90 receiver, whose limiter circuit is shown at Fig. 7.

THE DISCRIMINATOR

The 3rd major point of difference between an A.M. and F.M. receiver lies with the type of 2nd-detector or demodulator. In the F.M. receiver, a discriminator detector, as shown in Fig. 8, is used. The discriminator consists of a push-pull diode detector in which opposing voltages developed across load resistors are equal and opposite so long as the carrier frequency rests at the intermediate frequency. The resultant voltage across the 2 load resistors, from point A to ground is zero, and no audio voltage is developed.

When the signal impressed upon the discriminator transformer is frequency modulated, due to phase changes as a result of both magnetic and capacity coupling, the voltage drops across the load resistors will be unequal as the frequency varies above and below the intermediate frequency with modulation. The resultant voltage measured across both diode load resistors will then be equal to the difference between the voltages developed across each; and will vary in polarity from point A to ground as the modulation swings the frequency higher and lower than the resting or resonant frequency. The degree of modulation, or frequency swing, determines the magnitude of

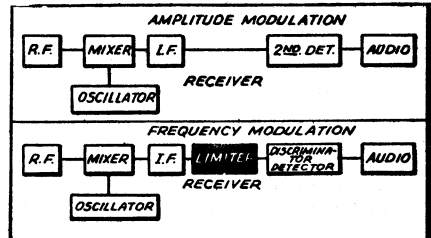

FIG. 1 ~ SIMPLIFIED BLOCK DIAGRAMS SHOWING SEQUENCE OF A.M. AND F.M. RECEIVER STAGES ~

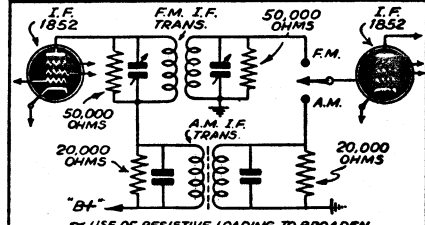

FIG. 2 ~ USE OF RESISTIVE LOADING TO BROADEN RESPONSE CHARACTERISTICS. PILOT FM 12 ~

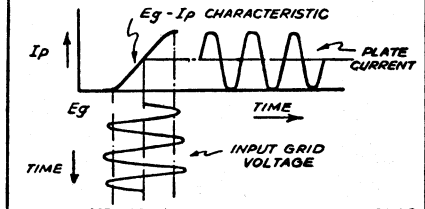

FIG. 3 ~ ACTION OF LIMITER IN CLIPPING MODULATION PEAKS BEYOND LINEAR PORTION OF CHARACTERISTIC ~

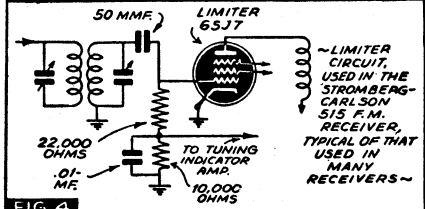

FIG. 4

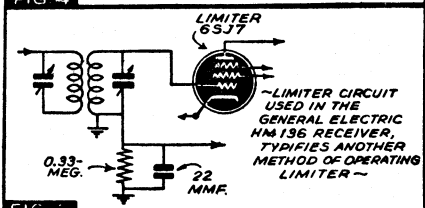
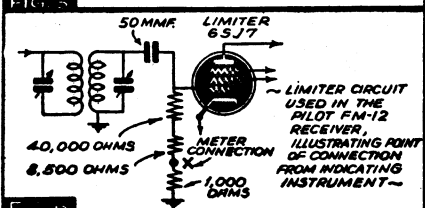

FIG. 5



ALL ABOUT FREQUENCY MODULATION

the voltage; and, the number of times per second, or rate at which the I.F. signal swings above and below the resonant frequency, produces the audio signal.

NEED FOR ALIGNMENT

Although most common troubles encountered with A.M. receivers, such as faulty condensers and resistors, are not foreign to F.M. receivers, and are located in like manner, probably the major difficulty with F.M. receivers is that of alignment. In an A.M. receiver, the result of I.F. stages only slightly misaligned is a loss in sensitivity and selectivity.

The result of misalignment in an F.M. receiver is much more apparent and serious, unless the I.F. stages and discriminator are accurately aligned, not only will loss in sensitivity be experienced, but also the symptoms of distortion and noisy reception will be encountered. The need for precise alignment of the I.F. and discriminator stages cannot be overemphasized. Despite statements to the contrary, new receivers often require realignment, due to changes occurring in shipment and delivery, where adjustment trimmers or circuit leads shift sufficiently to influence alignment. This is so, notwithstanding precautions taken by designers to avoid, by careful packing, bonding, and engineering, the possibility of changes. For this reason, the alignment of F.M. receivers should be thoroughly understood. *It must be remembered, however, that most new receivers reach their final destination in perfect condition, and the impression that all receivers must be realigned is not intended.* Before alignment is attempted, the symptoms displayed during receiver operation must warrant the need for the procedure. Noisy operation and distortion is not always the result of misalignment. More often, it is due to insufficient signal pick-up, the cause of which may be a faulty antenna system, faulty in the sense that the dipole may not resonate at the F.M. band or be properly oriented—transmission line mismatch to the dipole or receiver, or the use of a transmission line with high R.F. losses.

The procedure followed in F.M. receiver alignment is similar in many respects to that employed with A.M. receivers, but with several important differences. In A.M. receiver alignment, a low input signal is used to adjust tuned circuits to prevent excessive action of the automatic volume control (A.V.C.) and thereby circumvent the use of an output indicator. A strong signal is necessary to align F.M. receivers, a signal strong enough to saturate the limiter tube, since this condition is normal during regular operation. The output indicator is no longer a copper-oxide rectifier type of A.C. meter connected to output plate or voice coil circuits.

There are 2 recognized methods of aligning the I.F. and discriminator stages of an F.M. receiver. One is through the use of a wide-band, frequency-modulated signal generator, and oscilloscope, which is called *visual or variable-frequency alignment*, a procedure employed by many manufacturers who claim that this is the only proper way to obtain perfect alignment. A second method, referred to as *fixed-frequency alignment*, makes use of a signal generator and a sensitive milliammeter, such as is used in 20,000 and 10,000 ohms/volt voltmeter instruments.

VISUAL ALIGNMENT

The vertical plates of the oscilloscope are connected to the "high" side of the limiter lead resistor, as shown in Fig. 9, and the ground terminal is connected to ground or chassis of the receiver. The signal generator is connected to the control-grid of the 1st-detector or mixer, and ground, the same ground connection used for the oscilloscope. (In the General Electric F.M. adapter or receiver using 2 1st-detectors, the signal is fed into the 2nd mixer).

The wide-band frequency sweep oscillator may be incorporated within the signal generator or contained in the oscilloscope. In any case, the sweep oscillator is heterodyned with the signal generator *unmodulated* output to produce the specified intermediate frequency signal for the receiver under alignment. Use the widest sweep frequency that is possible with the equipment employed, since correct adjustment is simplified. In some signal generators and oscilloscopes, a sweep frequency as high as 750 kc. is available. In others, a sweep frequency of only 200 kc. to 300 kc. is possible. When the frequency modulator is contained within the oscilloscope, synchronizing is no problem. Otherwise, a synchronizing voltage from the "wobbulator" must be injected into the oscilloscope to obtain a steady pattern. Starting with the limiter input transformer, and proceeding back to the 1st I.F. transformer, adjust trimmers of each I.F. transformer to obtain a symmetrical response curve closely similar to that illustrated at Fig. 10.

In some receivers, a stage-by-stage or progressive alignment, rather than an overall alignment will produce better results. The frequency-modulated signal generator output is connected to the control-grid of the I.F. amplifier preceding the limiter and the limiter transformer is adjusted to obtain a curve with steep sides and wide peak. Each transformer is then adjusted after the signal generator connection is made to the control-grid of the tube preceding that transformer. These I.F. transformers should be adjusted to give *maximum width consistent with maximum vertical deflection*. No

ALL ABOUT FREQUENCY MODULATION

over-all adjustments are made after this stage-by-stage alignment is completed.

A dummy antenna, consisting of a 0.05-mf. or 0.1-mf. condenser, must be used in series with the "high" side of the signal generator and tube control-grid. When the generator is coupled to the grid of the mixer, insufficient output may result due to the low impedance of the R.F. coil in the mixer grid circuit. In this case, it may be necessary to temporarily disconnect the R.F. grid lead from the mixer control-grid, and couple the generator through the dummy antenna directly to the mixer. A resistor, from 10,000 to 25,000 ohms in value, must be connected from tube grid to ground to complete the grid circuit.

To align the discriminator, the oscilloscope is connected across the diode load resistors. The vertical plates are connected as shown in Fig. 11, and the ground terminal to the ground or chassis of the receiver. Without altering or disturbing the frequency setting of the frequency-modulated signal generator, which is coupled to the control-grid of the mixer, adjust the primary and secondary trimmers of the discriminator transformer, referred to as Cp and Cs, to obtain the "S" or "X" trace on the screen of the oscilloscope as shown in Fig. 12.

The type of pattern depends upon whether single- or double-trace alignment is employed. It can be seen that the center part of the single trace is a straight line and is centered and symmetrical with respect to all axes. The double-trace discriminator characteristic must also be centered and symmetrical, as shown, with the crossover at the horizontal and vertical axes. When trimmer Cs (Fig. 11) is adjusted to more than correct capacity, the traces illustrated at Fig. 13 will be obtained. The traces shown at Fig. 14 picture the condition resulting when Cs is adjusted to less than correct capacity. The adjustment of trimmer Cp (Fig. 11) determines the linearity of the center portion of the trace, which must be straight. Incorrect alignment of Cp may provide a trace shown at Fig. 15. Since the adjustment of Cp and Cs inter-lock to some extent, it is usually necessary to readjust Cs again after Cp is aligned. When the "S" or "X" trace seen at Fig. 12 is obtained, the discriminator alignment is complete.

FIXED-FREQUENCY ALIGNMENT

Highly satisfactory and accurate alignment of the I.F. and discriminator stages of an F.M. receiver may be accomplished without a frequency modulator and oscilloscope. For this purpose, a calibrated signal generator and a sensitive D.C. indicating instrument are essential. The indicating instrument may be a D.C. vacuum-

tube voltmeter or a 10,000 or 20,000 ohms/volt volt-ohmmeter combination with several low-current ranges. Stage-by-stage alignment is employed, starting with the limiter stage input transformer.

The signal generator is adjusted to provide an unmodulated output at the correct intermediate frequency for the receiver under alignment, and is coupled to the control-grid of the I.F. amplifier tube preceding the limiter input transformer. A dummy antenna consisting of a 0.1-mf. condenser, connected in series with the high side of the generator to the tube grid, is important. The ground lead or shield of the generator output cable must be properly grounded to the receiver.

Since the current flowing in the grid circuit of the limiter is proportional to the signal, connection of the output indicator is made to the limiter stage. The mode of connection depends upon the type of indicator and limiter. When an electronic or D.C. vacuum-tube voltmeter is employed, it is only necessary to connect it from the control-grid of the limiter tube and ground, or across the load resistor as shown in Fig. 17. Otherwise, a milliammeter is connected in series with the load resistor, shown in Fig. 18.

In some receivers, a low-value resistor of about 1,000 ohms, part of the limiter load, is provided so that the milliammeter may be shunted across the resistor. Inasmuch as the meter resistance is much less than that of the 1,000-ohm resistor, the greater portion of the grid current will flow through the meter. This circuit is shown at Fig. 19. It is advisable to use twisted-pair leads to connect the meter to the circuit.

Each I.F. stage is adjusted to provide maximum deflection or reading on the D.C. electronic voltmeter or milliammeter, coupling the signal generator successively to the control-grid of each I.F. amplifier to the mixer grid. The adjustment will be found to be broad due to the wide-band characteristics of the I.F. transformers. When this procedure is completed, and with the signal generator coupled to the mixer grid, the frequency setting of the generator should be changed 75 kc. or 100 kc. above and below the correct intermediate frequency, noting the reading on the indicating instrument in each case. When the I.F. amplifier is correctly and accurately aligned, the reading on the meter should decrease an equal amount above and below the intermediate frequency. The alignment should be repeated until this condition results. Keep the signal generator output low when adjusting I.F. stages, just below the point where further increase in signal

output produces no change in the meter reading.

To align the discriminator, the signal

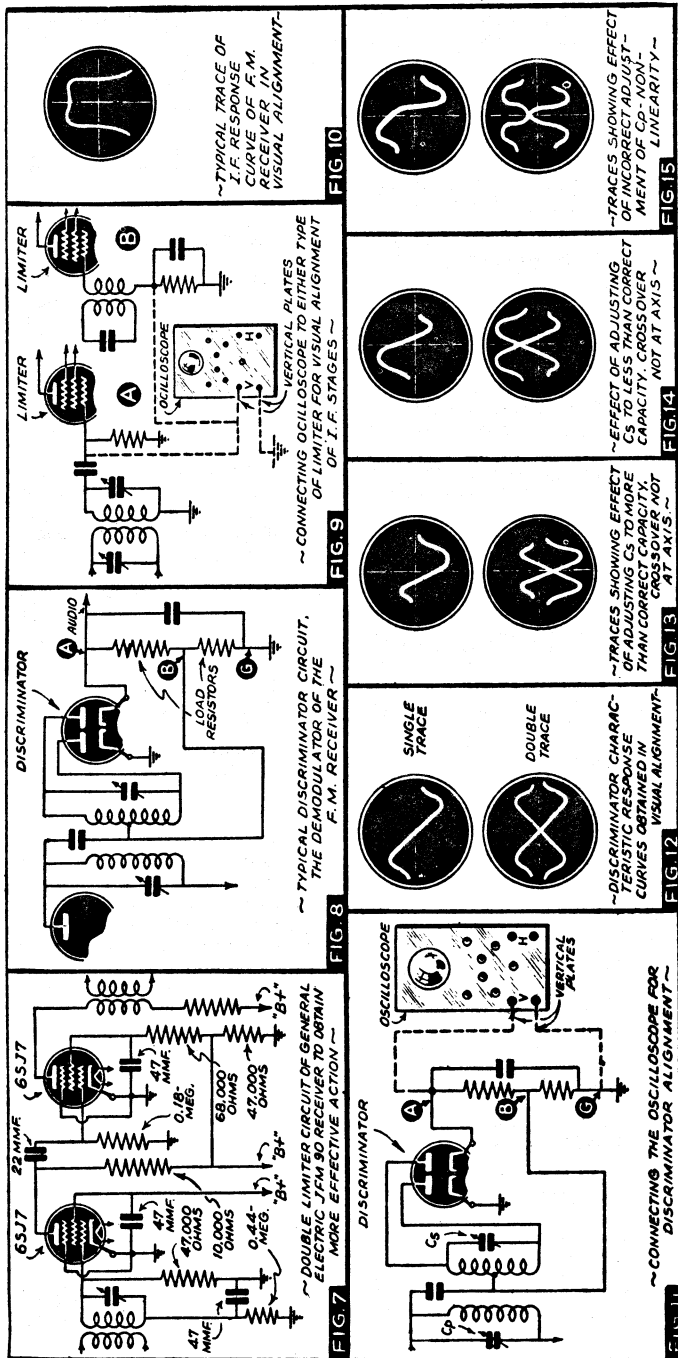

generator is coupled to the limiter control-grid or the mixer grid in accordance with individual manufacturers' instructions. In this instance, a strong input signal is required. The output indicator is connected to the discriminator load resistors as shown at Fig. 20A. When a V.T.V.m. is used, the probe or high side is connected to point A or B, and the ground terminal to the chassis of the receiver. The primary trim-

mer C_p is adjusted for maximum reading on the meter with the probe at B. The secondary trimmer C_s is aligned for zero reading with the probe at A. When a D.C. milliammeter is employed as the output indicator (a zero-center type is advantageous but not entirely essential), it is connected in series with the lower diode load resistor and ground as shown in Fig. 20B. Trimmer C_p is adjusted for maximum

reading and trimmer C_s aligned for zero reading. Care should be exercised when using a microammeter without zero center since the meter will read below scale when the secondary trimmer is adjusted in the other direction.

A high-resistance D.C. voltmeter of 20,000 or 10,000 ohms/volt sensitivity may be used as the indicating instrument and is connected from point A to ground, but the

ALL ABOUT FREQUENCY MODULATION

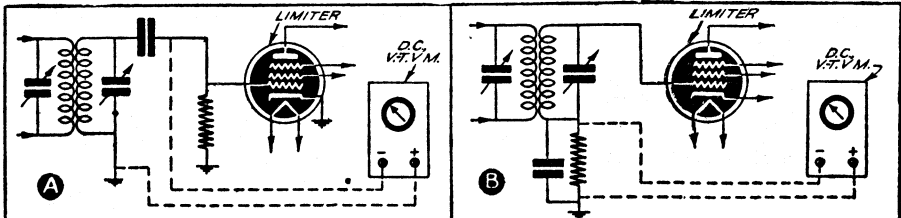

FIG. 17 ~CONNECTING A V.T.V.M. TO EITHER TYPE LIMITER CIRCUIT TO ALIGN I.F. STAGES~

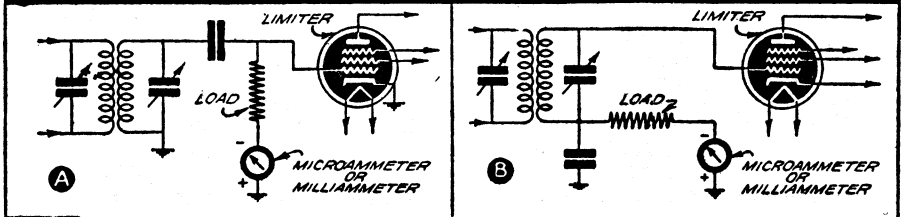

FIG. 18 ~CONNECTING A MICROAMMETER OR MILLIAMMETER TO LIMITER CIRCUIT TO ALIGN I.F. STAGES~

precaution mentioned in connection with meters without zero center must be observed. It is possible to change the zero adjustment of the meter to read up-scale to avoid slamming of the needle off-scale when the secondary trimmer is adjusted.

The following procedure is suggested only as a means of accomplishing I.F. and discriminator alignment when other essential equipment is not available.

Since an audio signal is developed across the limiter load resistor in the circuit shown at Fig. 5, a modulated signal and conventional copper-oxide rectifier type of output meter may be employed to align the I.F. stages in an F.M. receiver. The meter is connected in the usual manner to the output tube plate circuit, and the input of the audio amplifier is connected to the limiter load resistor. The I.F. transformers are then peaked for maximum reading on the meter. The discriminator is aligned by connecting the audio-amplifier input to point B, the junction of the diode load resistors, shown at Fig. 8, and the discriminator transformer trimmers adjusted for maximum indication on the output meter.

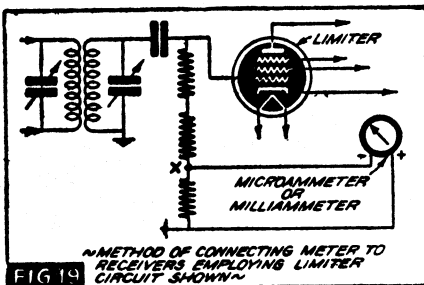

FIG. 19 ~METHOD OF CONNECTING METER TO RECEIVERS EMPLOYING LIMITER CIRCUIT SHOWN~

R.F. AND OSCILLATOR ALIGNMENT

The alignment of the radio frequency and oscillator stages in an F.M. receiver presents no problem and is carried out in conventional manner, similar in all respects to A.M. receiver alignment. Calibration of the high-frequency end of the F.M. band is possible with the oscillator shunt trimmer, but because of the narrow spread or limits of

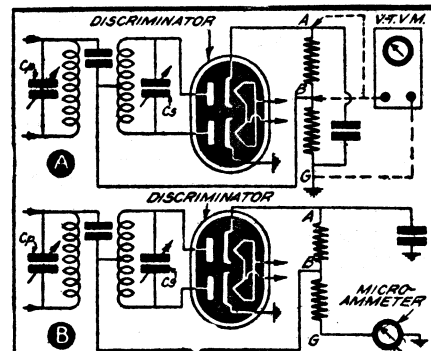

FIG. 20 ~METHOD OF CONNECTING INDICATOR FOR DISCRIMINATOR ALIGNMENT~

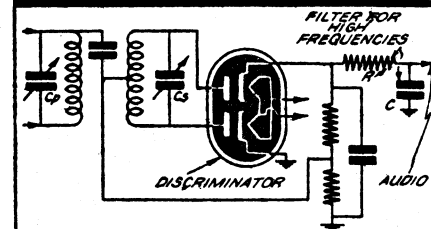

FIG. 21 ~POSITION OF HIGH-FREQUENCY ATTENUATING FILTER IN DISCRIMINATOR-AUDIO CIRCUIT. REDUCTION IN R OR C VALUES WILL INCREASE HIGH-FREQUENCY RESPONSE~

ALL ABOUT FREQUENCY MODULATION

the band, no oscillator padding condenser is provided. When padding of the oscillator circuit to calibrate the low-frequency end of the band is required, an end turn of the oscillator coil may be shifted slightly to effect the alignment.

In connection with oscillator alignment, it must be remembered that the oscillator in an F.M. receiver of conventional design is operated *below* the signal frequency, not above, as in A.M. receivers. This is done to avoid possible image frequency interference from the television channels that lie above the F.M. band, and to secure greater oscillator stability. The dummy antenna for R.F. and oscillator alignment consists of a resistor of 100 ohms value connected across the antenna input to the receiver.

One of the advantages claimed for F.M. receivers is the extended high-frequency range. In some cases, brilliance in reproduction of the high frequencies may be lacking or inadequate, despite correct alignment and operation. It is only necessary to change the constants of the filter circuit, shown in Fig. 21, connected between the discriminator and audio amplifier. This filter, consisting of resistance and capacity, is used to attenuate the high-frequency boost introduced in transmission, thereby

tending to flatten out the overall audio frequency response. Removal of the filter entirely is not recommended, but a change in the time constant, usually 100 microseconds, may be warranted. By reducing the value of the resistance or capacity, an increase in high-frequency reproduction is secured.

On the whole, the radio technician who recognizes and understands the major differences between F.M. and A.M. receivers should have little difficulty in the installation and service of F.M. receivers.

Another common trouble with F.M. receivers is distortion. This condition is caused by any one or more of a number of failures, but principally, incorrect I.F. discriminator alignment. When the discriminator characteristic is not linear, frequency changes in the signal will not be converted into a sine audio voltage. Misalignment of the I.F. amplifier may result in unequal amplification of the wide frequency band essential for correct operation, and consequently a non-linear discriminator response. Both the I.F. amplifier and discriminator must be aligned to the same frequency and the response of the I.F. amplifier must be equal over the required spread on both sides of the intermediate frequency.

PART III

TEST EQUIPMENT FOR F. M. SERVICING

Most Servicemen already realize that their present test equipment will not adequately take care of the requirements of F.M., but there is much confusion and difference of opinion regarding the equipment which will be required. Most of this confusion is due to the fact that few people have had any actual experience with F.M. receivers in order to really know the requirements.

The majority of the present worries have been based upon the problems arising from the wide band of transmissions. Experience will soon show that the band-width is the least of the worries, although it does enter into the picture somewhat. The biggest problem is to get test equipment which will

function at all at 40 to 50 megacycles!

In order to simplify an understanding of the major factors in servicing F.M. radio receivers and adapters the following description is divided into 5 sections identified as follows: (A) I.F. alignment; (B) discriminator adjustments; (C) R.F., detector and oscillator adjustments; (D) locating receiver troubles; and, (E) testing tubes.

TEST UNIT NO. 1:

I.F. SERVICE OSCILLATOR

A.—In aligning F.M. receivers there is no way of controlling the band-width. That has been left entirely to the manufacturer.

ALL ABOUT FREQUENCY MODULATION

Illustrated here are representative, Weston precision instruments suitable for efficient testing and alignment of frequency modulation receivers. They are identified as follows: A, model 776 oscillator; B, model 787 high-frequency oscillator; C, model 669 V.-T. voltmeter.



The Serviceman cannot possibly change the coupling between the coils on intermediate frequency transformers and expect any degree of success. In actual practice all I.F. adjustments are made for peak performance at the intermediate frequency which usually lies between 1 and 5 megacycles, depending upon the individual manufacturer. The transformers cannot be stagger-tuned in an attempt to broaden the band-pass characteristics. Any attempt in that direction will result in all kinds of distortion. The most important point in connection with the I.F. alignment is that all adjustments be made at exactly the same frequency. This requires, therefore, a service oscillator which is free from drift at 1 to 5 megacycles. There is one such oscillator available, designed with a negative feed-back circuit which is referred to as *automatic amplitude control*. This results in remarkable stability at the required frequencies.

TEST UNIT NO. 2:

U.-H.F. SERVICE OSCILLATOR

B.—The only other circuit in F.M. receivers which is particularly annoying to the Servicemen at present is the discriminator circuit. However, if we analyze this portion of the receiver very carefully it will soon be seen that this is exactly the same as similar

circuits which were used for automatic frequency control in A.M. receivers. See Fig. 1. The adjustment of these circuits is exactly the same as shown.

C.—The last adjustment required in the new type of equipment is that of the R.F. detector and oscillator circuit. These adjustments must be carried out using a service oscillator which is capable of accurate tuning at between 40 and 50 megacycles. Such equipment is extremely rare at the present. Any attempt to use harmonics of lower frequencies will be very annoying and confusing. Furthermore, it will be impossible to check the band-width characteristics of the receiver as is often desired. An oscillator using inductive tuning capable of operation from 30 to 150 megacycles is particularly suitable as its tuning characteristics at F.M. frequencies is better than anything else now available. On this unit one division of the dial at 40 megacycles represents only 40 kilocycles, making it convenient to tune through the desired band of 100 to 150 kilocycles.

At the present stage of affairs there has been an expression on the part of some people of the desire for a service oscillator, capable of being 100-kc. F.M. wobbled, to be used in conjunction with an oscilloscope. If such equipment were available it would serve

ALL ABOUT FREQUENCY MODULATION

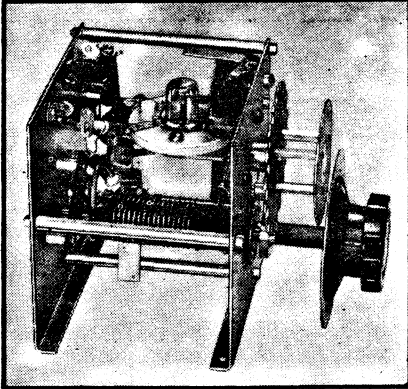

Chassis of the Weston model 787 oscillator tuner, assembled.

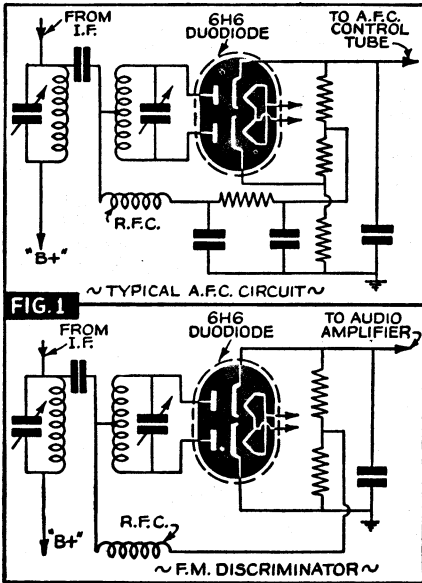

to very little advantage as all adjustments would still have to be made for peak response. The oscilloscope would function as nothing more than a visual type of voltmeter. The various I.F. transformers could not be adjusted any more accurately or quickly with such a setup.

TEST UNIT NO. 3: V.-T. VOLTMETER

D.—In locating the troubles in F.M. receivers, it will once again be necessary to resort to fundamental test equipment such as 20,000 ohms/volt analyzers, vacuum-tube voltmeters, etc. Due to the frequency of operation the many types of so-called signal tracers will be of doubtful assistance as they have all been designed for operation at the present A.M. broadcast frequencies. The most logical instrument for localizing receiver troubles in F.M. equipment will be a vacuum-tube voltmeter capable of measuring the A.C. signal voltages at from 1 to 50 megacycles. There are a few such voltmeters which have been available for some time.

E.—The testing of tubes in F.M. equipment will present quite a problem, as many tubes capable of satisfactory operation at the lower frequencies will fail completely at the F.M. frequencies. Tubes such as the 1852 and 1853 must be used in order to obtain sufficient gain at high frequencies. Those tubes have very small elements closely spaced, and are much more susceptible to leakage and shorts than the other, more common types. Experience has also proven that no commercial tube tester will satisfactorily indicate the quality of a tube which is to be used as an oscillator at 50 megacycles.

Because of the fact that very little work has previously been done at these higher frequencies, it is perfectly safe to prophesy many new and radically different types of tubes during the coming few years. The tube checker picture, therefore, is the only uncertainty in the consideration of suitable test equipment for F.M.

It is hoped that in the excitement and rush resulting from the widening of activity in F.M. the Serviceman will keep his head in the selection of equipment. Do not be too anxious to jump at the purchase of equipment which is represented to be a cure-all.

Above all do not let any one give you the idea that there is anything tricky or complex about F.M. receivers. When it comes right down to reality the circuits and component parts which are used are no different than those already familiar to everyone. The real issue is the operating frequency of 40 megacycles, and the only problem is to get equipment which is designed carefully and accurately enough to reliably operate at that frequency of 50 megacycles.

CHAPTER V

ENGINEERING

The How and Why of Frequency Modulation

THERE is widespread belief that many present-day developments are fundamentally new within the last few years.

On the contrary, the bases of many so-called new developments date back a great number of years. It is true, however, that only recently has it been possible to utilize to fuller advantage the possibilities of many of the ideas passed down to us by early investigators of the Radio Art. New instrumentalities have made it possible to explore these fundamental ideas to much greater extent. Transmission and reception at ultra-short wavelengths, or ultra-high frequencies, is one such outstanding example.

U.-H.F.

The use of the ultra-high frequencies for sound broadcasting offers technical advantages, not only to the broadcaster but to the public, which is much more important. The technical advantages consist of (a) escaping the 10-kc. channel limitation, (b) getting away from static, and (c) eliminating all except spasmodic long-distance interference.

We've known this for years, have experimentally operated low-power U.-H.F. stations since Way Back, and have enjoyed the experience of receiving Clean Stuff from our little ultra-high frequency transmitters when QRN, with devastating wallops, washed out our temporarily musclebound 50 kw. steamrollers. Five years ago the F.C.C. had applications for, or had licensed, over 100 ultra-high frequency transmitting plants and it seemed that a trend was developing toward ultra-high frequency broadcasting, but this trend was not sustained. Interest has been revived in recent months through the promotion of F.M. on the ultra-high frequencies.

WHAT DOES F.M. OFFER?

Frequency Modulation is a weapon against noise, a *sword* if you please, with advantages which can be calculated accurately and simply, as we shall see. But unreasonable powers should not be attributed to it. The pen should not be mightier than the sword.

Your scribe bows low and humbly attempts, with these hesitant strokes, to bring to you gentlemen of the *A.T.E. Journal* what the Lower Classes vulgarly call the Lowdown. A snack of inside dope.

Let's get to the point. What advantages does F.M. really give over A.M.? Using the frequency deviation approved for the industry by the F.C.C., F.M. UNDER THE OPTIMUM CONDITIONS gives (a) an advantage of 20 to 1 in background noise suppression, (b) an advantage of at least 30 to 1 in rejection of shared-channel interference, depending on the beat frequency, and (c) some advantage to the broadcaster in capital expenditures and operating costs. There you have it.

F.M. IN 1902!

One frequently meets laymen who have the mistaken idea that F.M. is a revolutionary new invention. The justly proud father of your profoundly humble scribe bought him his first lace velvet pants in 1902. Most of you were still unborn during that antediluvian era.

It was in that year that a gentleman named Ehret applied for a patent which was issued in 1905 covering the basic method of F.M. for voice and code transmission and reception!

Mr. Ehret proposed to shift the carrier frequency by means of a voice-actuated condenser. He proposed an off-tuned circuit in the receiver for converting the frequency-modulated waves into waves of varying amplitude.

ALL ABOUT FREQUENCY MODULATION

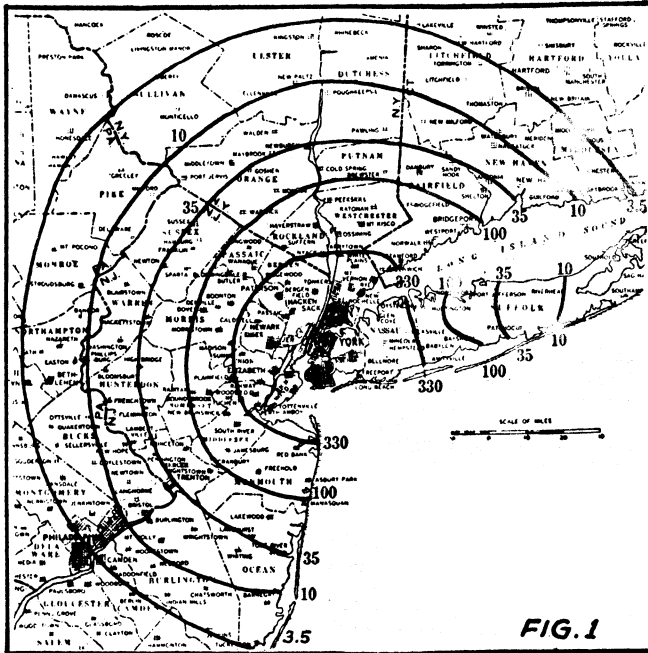

"W2XWG's field intensity pattern in micro-volts/meter (irrespective of the type of modulation). These measurements represent a power of 1,000 W., a transmitting antenna height of 1,300 ft., a receiving antenna height of 30 ft. and an operating frequency of 42.6 megacycles."

With certain improvements these are the methods now used. For code signalling he proposed to key the transmitter inductance or capacity to change the carrier frequency. Before the No. 1 war this method was very widely used for many years on longwave transmitters. Remember how discombobulated one could become by trying to read the backwave when fatigued?

"WIDE SWING" F.M.

Frequency Modulation research has been carried on for over 30 years and, except for 1918, 1920 and 1924, patents have been issued on F.M. methods and devices each year for the last 25 years. They were granted mostly to a number of inventors in the employ of organizations which spend large sums on research, such as G.E., Westinghouse, A.T.&T. and to a few individuals, particularly Major Edwin H. Armstrong who has promoted use of the feature of "wide swing" in F.M.

Other features are important in F.M. such as limiting. Gentlemen named Wright and Smith filed a patent application covering it 15 years ago. Fourteen years ago, and subsequently, patent applications were filed and granted to Westinghouse, A.T.&T. and RCA on balanced, or "back-to-back" F.M. demodulators. The most commonly used discriminator today was patented by S. Seelye of RCA. Frequency multiplication of an F.M. wave to increase the frequency shift is covered in patents issued to West-

inghouse, and G.E., for which applications were filed in 1926 and subsequent years. High frequency pre-emphasis and de-emphasis circuits were patented by S. Seelye and others of RCA. Its introduction to the industry was due in considerable part to the efforts of N.B.C.

At the close of 1939 more than 250 patents had been granted on either Frequency or Phase Modulation, of which more than 160 covered F.M. About 10 years ago R.C.A.C. was trying F.M. on channels between our East and West coasts. About 12 years ago your scribe co-operated with Westinghouse in F.M. tests between New York and Pittsburgh. So you can see F.M. isn't new.

HI-FI A.M.

There is a popular impression that by use of F.M. and "wide swing" the public may only now enjoy high fidelity. The facts are that with ultra-high frequencies the fidelity can be made as good as anyone wants it to be with either frequency or amplitude modulation. Any improved fidelity is made possible by getting away from the 10-kc. channel allocations of the Standard Broadcasting Band and not by using F.M.

Furthermore, to get "high fidelity" in A.M. or F.M. receivers the listener must pay exactly the same high price for high-power, low-distortion audio amplifiers, loudspeakers and acoustical systems. However, the time may come when High Fidelity will receive the widespread recognition it merits.

ALL ABOUT FREQUENCY MODULATION

There is much more interest now in low receiver prices which preclude high fidelity. This is unfortunate but incontestably true regardless of any wishful or idealistic thinking to the contrary.

There is no lack of satisfactory fidelity in present-day transmitters because, if for no other reason, the F.C.C. requires it. The loss of fidelity rests in the home receivers. Medium-priced receivers satisfy the public demand and high fidelity cannot be obtained in those models. The price paid for so-called high-fidelity amplifiers and loud-speakers is in itself more than the cost of most receivers. Possibly 1 person in 6 has a receiver of good fidelity. Many of these listeners normally operate with the tone control adjusted for the lowest degree of fidelity possible with such receivers. It appears that the public is not suffering any lack of fidelity because of the present broadcasting system.

We in N.B.C., and others, have been providing transmission of excellent fidelity for at least 15 years (network lines excepted) and will continue to do so. We believe in it and endorse it. But we have no illusions about the public reaction toward it.*

NOISE THRESHOLD

Frequency Modulation would under favorable conditions, but not all conditions, reduce static about 20 to 1. But what static are we talking about? Static practically doesn't exist on ultra-high frequency. Therefore, isn't its absence mainly due to the shift to the ultra-high frequency band? It is.

Don't think that your humble servant is bearish on F.M. because that would be incorrect. It is cold professional realism, not bearishness. An F.M. station will provide noise-free service to a much greater distance than an A.M. station of equal power because F.M. can suppress receiver hiss noise, auto ignition noise and other ultra-high frequency disturbances about 20 to 1, if the carrier is stronger than the noise and if the receivers have enough gain to make the limiters limit at low field intensities. Some F.M. receivers begin to slack off at about 100 microvolts. To obtain the full benefit of F.M. out to the "noise threshold" limit they should hold up down to 10 microvolts. This noise threshold is strictly an F.M. phenomena; more on this later.

We are all confident that Television has a most brilliant future. We are not entirely clear on the position that Ultra-High Frequency Sound Broadcasting will have with respect to it. Those of us who have lived with television for many years feel that sound is supplemental to sight but definitely second in importance. When television hits its stride, sound broadcasting

may assume the status of silent pictures. Who knows? Nobody does. In any event, sound broadcasting will be with us for many more years and we should give full opportunity to improved methods and devices. F.M. is one of them. N.B.C. has one F.M. station and will build more. F.M. is being given its chance to prove itself.

The N.B.C. has for many years viewed realistically the advantages of the ultra-high frequencies and has been confident that the industry would, in time, do likewise. Five years ago Mr. Hanson and your profoundly humble scribe wrote a long report on the subject forecasting the growth of ultra-high frequency Sound Broadcasting by 6-month intervals and hitting very close. Frequency Modulation had such promising theoretical advantages that we undertook a full-scale field test to determine the extent to which they could be realized in practice.

\$30,000 WORTH OF TESTS

As a result we completed, last year, at a cost of over \$30,000, the most thorough field test of F.M. ever undertaken and we have the information we sought.

It was obtained, not by laboratory work, which had been done before by others, including R.C.A.C., nor merely by operating an F.M. station, but by building special transmitters, receivers, measuring instruments, etc., and then painstakingly making thousands of measurements at distant points over many months and under a variety of conditions.

A special 1,000-watt transmitter was ordered from the R.C.A.M. Company. It had facilities for both A.M. and any degree of F.M. deviation or "swing" desired, with remote control facilities for instantaneously switching to either system. Since the F.M. deviation varies directly with the audio input level, remote controlled pads could be and were used to select the deviation desired.

W2XWG was installed in the Empire State Building. Special authority was obtained from the F.C.C. to use amplitude modulation as well as F.M. on 42.6 mc. for the term of the project. The television video antenna, having a pass band extending from 30 to 60 megacycles, was used for most of the W2XWG transmissions although a special folded dipole was used when the video antenna was transmitting "pictures."

W2XWG was equipped with means for continuous variation of power between 1/10-watt and 1,000 watts, and a vacuum-tube voltmeter for accurately measuring the power.

The modulation conditions selected were A.M./F.M. 15 (deviation of 15 kc., or total swing of 30 kc.), and F.M. 75 (deviation of 75 kc. or total swing of 150 kc.). Tone modulation was used for most measure-

(* See the first item under "SOUND" in the June, '41, issue of Radio-Craft, pg. 715.—Editor

ALL ABOUT FREQUENCY MODULATION

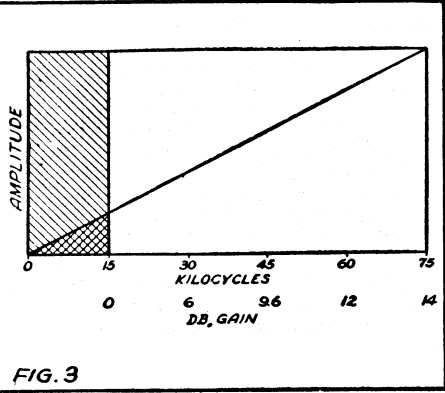
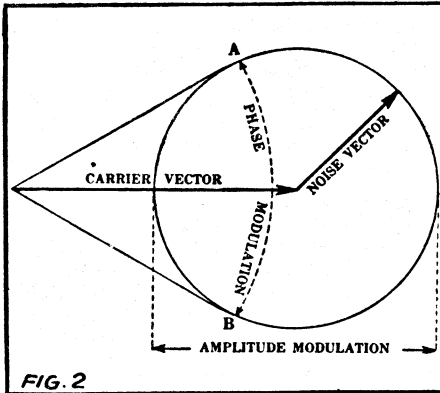

ments. For measuring distortion, or noise levels with modulation present, the tone output of the receivers was cleaned up by passing it through filters and then impressed upon RCA noise and distortion meters.

Four special receivers were built by the R.C.A.M. Company for this project. Each was equipped for instantaneous selection of A.M./F.M. 15 or F.M. 75. Two complete I.F. systems were built-in, one 150 kc. wide and one 30 kc. wide, each having 5 stages, with both A.M. and F.M. detectors. All receivers contained meters, controls, de-emphasis circuits with keys, 8-kc. cutoff filters with keys, separate high-quality amplifiers and speakers, cathode-ray oscillographs, etc. Each receiver had sufficient R.F. gain to give full output with limiting at input levels much lower than required, theoretically doing so with only 1/10-microvolt input. These receivers were made as good as receivers can be built in order that our conclusions on F.M. would not be clouded by apparatus shortcomings. *Sacrificing good receiver design to price will not permit the full gain of F.M., as reported herein, to be realized.*

FIELD INTENSITY

As a part of the project, a field intensity survey was made of the W2XWG transmissions. The map is included herein for 1,000 watts, 1,300 feet antenna height and .7 antenna gain. It is Fig. 1.

Measurements and electrical transcriptions were made under a variety of conditions at the following locations:

| | <i>Miles</i> |
|----------------------------|--------------|
| Collingswood, N. J. | .85 |
| Hollis, L. I. | .12 |
| Floval Park, L. I. | .15 |
| Fort Jefferson, L. I. | .50 |
| Commack, L. I. | .36 |
| Riverhead, L. I. | .70 |
| Hampton Bays, L. I. | .78 |
| Bridgehampton, L. I. | .89 |
| Eastport, L. I. | .65 |

| | |
|-------------------------|----|
| N.B.C. Laboratory | 1 |
| Bellmore, L. I. | 23 |

All above stations are temporary, with the exception of the last two, which are permanent.

Most of the measurements were made at the Bellmore station. For the temporary stations, 2 automobiles were equipped and used, one a Radio Facilities Group measuring car, the other a borrowed R.C.A.C. truck full of recording gear. The receiving stations represented a cross-section of rural and suburban Americana.

Let's next see what theoretical advantage F.M. has in noise suppression and how it is obtained. Later we will see what we measured.

In F.M. the deviation of the carrier frequency can be made as great as desired. If it is 15 kc. and the audio band-width is 15 kc. the deviation ratio is 1, corresponding to the deviation divided by the audio band-width. If the deviation is 30 kc. the deviation ratio is 2, etc.

The advantages of F.M. over A.M. in noise suppression are contributed by 3 factors:

- (1) The triangular noise spectrum of F.M.
- (2) Wide swings, or large deviation ratios.
- (3) The greater effect of de-emphasis in F.M. compared to A.M.

Let us consider them in order.

TRIANGULAR NOISE-SPECTRUM

An F.M. system with a deviation ratio of 1 has an advantage in signal-to-noise ratio of 1.73 or 4.75 db. for hiss or other types of fluctuating noise.

Since the figure 1.73 applies to such noises as *tube hiss*, which is comparatively steady in amplitude, we will consider this type of noise. It differs from *impulse noise* such as is produced by automobile ignition systems.

ALL ABOUT FREQUENCY MODULATION

Tube hiss consists of a great many closely overlapping impulses or peaks. There are so many of them at all audio frequencies, we are concerned with, that the noise has a steady characteristic. When combined with a steady carrier of fixed frequency, the noise peaks beat with the carrier. The noise peaks also beat with each other. When the carrier is considerably stronger than the noise peaks, beats between the noise peaks become negligible in amplitude and the predominating noise is due to the combination of carrier and noise peaks.

Since a combination of 2 carriers differing in frequency produces a similar phenomenon, we will treat both cases at the same time. The effect is most easily shown and understood by means of a simple vector diagram.

The strongest carrier vector continuously rotates through 360° and is indicated on Fig. 2. The weaker carrier, or the "noise voltage," rotates around the carrier vector at a frequency which is equal to the difference between the desired carrier and undesired frequency.

It will be seen that amplitude modulation is produced. If the undesired frequency is 50% as strong as the desired frequency, 50% amplitude modulation results. As the undesired vector rotates around the desired vector, *phase modulation* also is produced between the limits A and B. The faster the undesired vector rotates, or the faster the rate of phase change becomes, the greater becomes the momentary change in frequency and, therefore, the greater the frequency modulation becomes, because Frequency Modulation is a function of the first differential of phase modulation. Therefore, the amplitude of the frequency modulation noise or beat note varies directly with beat frequency. With both frequencies exactly the same there is no amplitude modulation nor

is there any frequency modulation.

Such being the case, the noise frequencies close to the carrier produce little frequency modulation noise but as the noise components further from the carrier combine with it they produce more frequency modulation. Therefore, the higher the noise beat frequency the higher its amplitude. This results in a frequency modulation noise spectrum in which the noise amplitude rises directly with its frequency. In other words, it is a *triangular spectrum*.

In amplitude modulation there is no such effect as this. All noise components combine with the carrier equally. Therefore in amplitude modulation there is a *rectangular noise spectrum*. The ratio of noise voltages in F.M. and A.M. is therefore the ratio between the square root of the squared ordinates of a triangle and a rectangle. This ratio is 1.73 or 4.75 db.

DEVIATION RATIO

For an F.M. System the suppression of *fluctuation noise* is directly proportional to the deviation ratio.

On Fig. 3 the A.M. noise spectrum corresponds to the total hatched area below 15 kc. because the I.F. system would cut off there. The F.M. 75 receiver I.F. system actually accepts noise out to 75 kc. and it has the usual F.M. triangular characteristic. However, the receiver output and the ear responds only to noise frequencies within the range of audibility, around 15 kc., and rejects everything else. Therefore, the F.M. 75 noise we actually hear corresponds only to the small cross-hatched triangle and all the rest is rejected.

The maximum height of this F.M. triangle, corresponding to voltage, is only $1/5$ th of the height of the A.M. rectangle. Such being the case the F.M. 75 advantage is 5 to 1, or 14 db.. Simple?

PART II

HOW AND WHY OF FREQUENCY MODULATION

TRANSMISSION and reception on ultra-short wavelengths is not a new idea—not even sound programs utilizing the technique of Frequency Modulation. The truth of this statement was discussed in Part I of this article

in which it was shown that the basic method of F.M. for voice transmission and reception was the subject of patents issued in 1905. From this general introduction, the writer proceeded to discuss subsequent technical developments culminating

ALL ABOUT FREQUENCY MODULATION

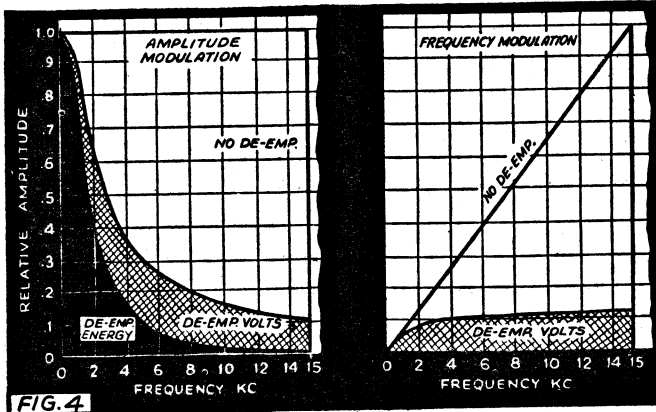

Fig. 4. High-frequency pre-emphasis is used in the transmitter and de-emphasis is used in the receiver to improve the signal/noise ratio. The importance of this characteristic in ultra-H.F. broadcasting and its greater effectiveness in F.M. are illustrated at left. Comparison is on the same scale of relative amplitude.

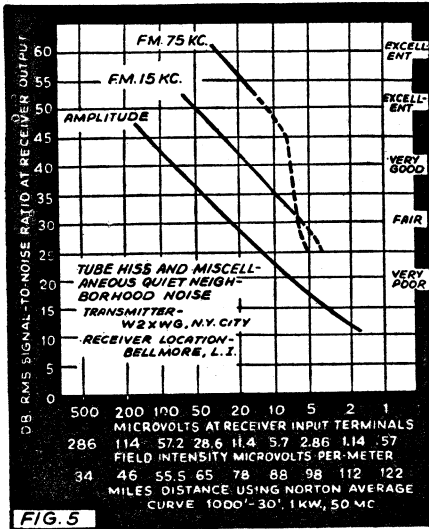

FIG. 5

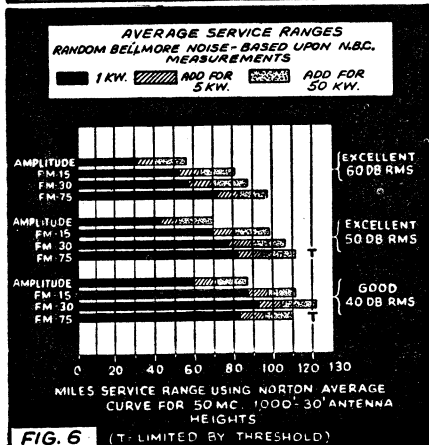

FIG. 6

in the wide-band system of F.M. espoused by Major Armstrong. The pros and cons of such characteristics as fidelity, noise threshold, triangular noise spectrum, deviation ratio, field intensity, etc., upon which tests were made at a cost of \$30,000 by N.B.C., were described.

We now continue with the further details of these tests, including discussion of pre-emphasis, de-emphasis, F.M. noise threshold (the effects of ignition interference, etc.), and the simultaneous operation of 2 F.M. stations on the same channel.

DE-EMPHASIS

When the high frequencies are attenuated in a receiver, the high-frequency noise is, of course, attenuated by the same amount. This may make a noisy signal more pleasant to the ear, but it degrades the fidelity. However, if the high frequencies are increased in amplitude in the transmitter, the overall fidelity will be restored. Nevertheless the noise which comes in at the receiver remains attenuated and therefore a reduction of noise results from this practice.

The use of a 100-microsecond filter to accomplish this purpose has been adopted as standard practice in Television and ultra-H.F. sound broadcasting by the Radio Manufacturers Association and recently by the F.C.C. It has actually been in use for several years. (Italics ours.—Editor) A 100-microsecond filter is a combination of resistance and capacity which will charge to 63% of maximum, or discharge to 37% of maximum in 100 microseconds.

It was shown that in F.M., the noise amplitude decreases as its frequency decreases whereas in A.M. it doesn't. Therefore, de-emphasis is more effective in F.M.

Consider Fig. 4. The full rectangle at the left is the A.M. noise spectrum. The full triangle at the right is the F.M. spectrum. The application of de-emphasis reduces

ALL ABOUT FREQUENCY MODULATION

these areas to those combining the hatched and black sections. Squaring those ordinates gives the black areas, corresponding to power, or energy. Extracting the square root of the ratios of these black areas gives the r.m.s. voltage advantage of F.M. over A.M. It is 4, corresponding to 12 db. Bear in mind that this 12 db. includes the gains contributed by both the triangular noise spectrum and de-emphasis. The spectrum advantage was 4.75 db. Hence the de-emphasis advantage is 12 db. minus 4.75 db. or 7.25 db.

All commercial F.M. receivers include de-emphasis and all F.M. transmitters include pre-emphasis. It's an F.C.C. requirement. (Italics ours.—Editor)

Now let's sum up. We saw (Part I) that the F.M. noise spectrum advantage was 4.75 db., the de-emphasis advantage was 7.25 db. and the deviation ratio of "F.M. 75" was 14 db. Combining these gives us 26 db.

Let's now see what advantage we actually measured as part of the field test project. Your attention is directed to Fig. 5 which has on it a great deal of information.

It actually condenses to one illustration much of the data we sought and obtained. Many pages could be devoted to it. The curves may be extended to the upper-left in parallel lines as far as desired. The actual field intensity of the noise can be determined from the A.M. curve. For instance, for 10 microvolts at the receiver terminals the A.M. signal-to-noise ratio is about 25 db. or 18 to 1. Hence the noise is 1/18 of 10 microvolts, or 0.6-microvolt r.m.s.

The ordinates are identified in receiver input microvolts, microvolts-per-meter and miles distance. Use the one you are most interested in. If you want condensed distance tables refer to the bar chart, Fig. 6.

Compare the measured gains with the calculations we went through. They look to be the same. They are. That means we found that the theoretical gain of F.M. can be and was obtained in practice.

Note the dotted sections of the F.M. curves. They are dotted to indicate that operation is not only below the "noise threshold" but is far enough below it that a noticeable increase of noise results as soon as modulation occurs. The dotted sections represent noise in the unmodulated condition. During modulation they break even sharper than indicated. Since there is no such thing as a noise threshold in A.M. there is no such break. Wherever usable A.M. entertainment service is provided "F.M. 15" is 12 db. quieter and "F.M. 75" is 26 db. quieter.

F.M. NOISE THRESHOLD

An interesting series of events takes place in a Frequency-Modulated system

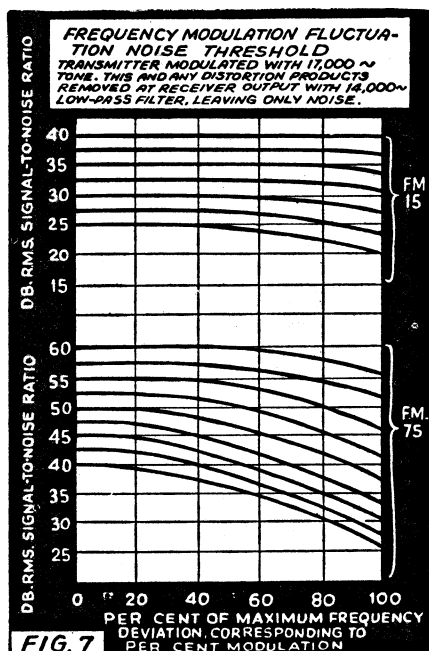

when the noise peaks equal or exceed the peaks of the carrier. The result is a rapid increase of the noise level or decrease of the signal-to-noise ratio with modulation.

In Frequency Modulation wherein the maximum swing is 150 kc. the point where this begins to occur is reached when the unmodulated signal/noise ratio is about 60 db. When the unmodulated signal/noise ratio is less than about 60 db., or 1,000 to 1, the noise level rises with modulation, and as the noise peaks exceed the carrier peaks by a considerable amount, this noise level may go up 20 db., or 10 times. When operating above the threshold limit the noise changes very little as the station is modulated. Below the threshold limit the effect is not unlike harmonic distortion in an overloaded amplitude transmitter.

In Frequency Modulation of a lesser swing, such as 30 kc., a similar effect occurs. In this case, however, the threshold limit occurs at about 35 db. signal/noise ratio. Figure 7 shows the results of some of the measurements we made. In order that the noise would not be confused with the small amount of inherent distortion in a practical F.M. system, the measurements were made in such a manner that the effects of distortion were eliminated. This was done by modulating the transmitter with a 17,000-cycle tone and eliminating at the output of the receiver with a 14,000-cycle low-pass filter, not only the fundamental modulating

ALL ABOUT FREQUENCY MODULATION

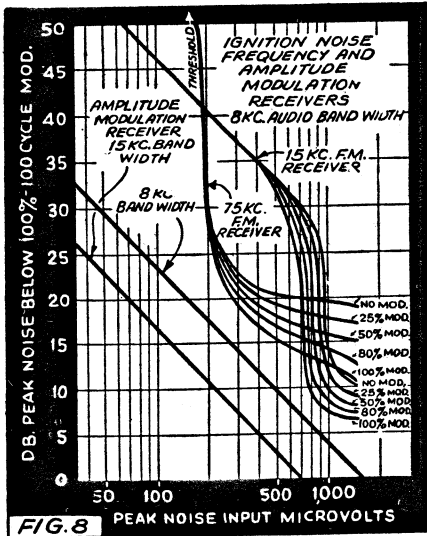

"F.M. 40" system having a total band width of 100 kc. occurs at about 43 db. Since this provides a very good signal/noise ratio and the required band width is only 100 kc., F.M. 40 is believed by many to have more overall merit than F.M. 75 when the comparative gains and limited space in the allocation spectrum are considered.

So far as is known, the data on the F.M. threshold effect presented here, and data published by Murray Crosby of R.C.A.C. constitute the only measured data ever published.

Figure 8 shows ignition noise measurements with peak noise input microvolts plotted against peak signal to noise ratio, based upon the signal resulting from maximum 400-cycle modulation. The "F.M. 15" threshold is shown. The F.M. 75 threshold is not shown because at the time the measurements were made A.C. hum within the system made the accuracy of S./N. measurements in the 60-db. region uncertain.

It should not be assumed that peak S./N. ratios of 20 or 30 db. are unusable when the noise arises from ignition systems because it isn't true. The relative infrequency of ignition peaks produces an audible result which is very deceiving. Ratios as low as 10 db., while distracting, do not entirely ruin service as is the case with fluctuation noise.

It will be noted that the curves of ignition noise threshold flatten off at the bottom. This is to be expected from the character of ignition noise. The impulses are very short in duration, very high in amplitude and (relatively) widely separated. They literally blank-out only small portions of the signal waves, without impairing the remainder. The short, blanked-out intervals of the signal change little over a wide range in noise peak amplitude. Once an ignition peak has risen to the value required to control the receiver and blank-out the signal a further rise in the noise level will not occur until the peak increases in breadth, or duration, or until there is a sufficient rise in certain low-amplitude components of ignition noise having fluctuation noise characteristics.

The peculiar shapes of such curves below the threshold values are due to the wave shapes and crest factors of ignition noise, but they are also influenced by the method of measurements.

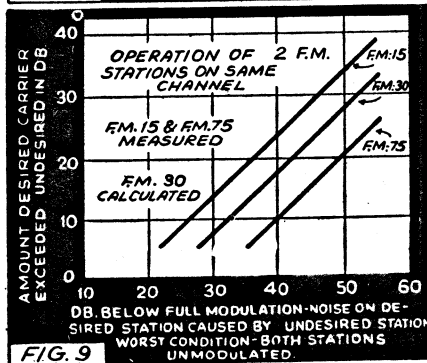

OPERATION OF 2 F.M. STATIONS ON THE SAME CHANNEL

By referring to the section covering noise interference it can be seen that the worst condition of shared-channel operation occurs when both stations are unmodulated and a fixed beat-note, therefore, results. It will also be seen that the higher this beat

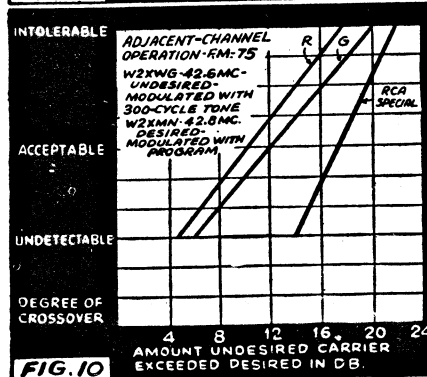

tone but all distortion products, leaving only the noise.

This effect has no doubt been observed by many without being understood. It is inherent in a frequency modulation system.

The noise threshold in the case of an

ALL ABOUT FREQUENCY MODULATION

note the greater will be its amplitude. Figure 9 was made on the basis of the worst conditions, which occur when the difference in carrier frequency reaches approximately 5,000 cycles. Were it not for the effect of de-emphasis in the receiver the beat-note amplitude would rise with frequency. However, de-emphasis of the high frequencies prevents that from happening and the effect may be further understood by referring to the section on pre-emphasis and de-emphasis. It will be noted that the noise on the desired station caused by the undesired station varies inversely with the deviation ratio; F.M. 75 has a deviation ratio of 5 compared with 1 for F.M. 15.

When either of the stations producing the beat-note becomes modulated, the beat-note disappears because one carrier sweeps across the other one. When the desired station is approximately 20 db. stronger than the undesired station, interference and cross-talk effects become unnoticeable. At 12 db. difference they are noticeable but it is the opinion of some engineers that the 12-db. ratio would be tolerable. Frequency Modulation offers a great advantage over Amplitude Modulation in the allocation of stations on the same frequency. In A.M. the

carrier amplitude of the desired station must be 100 times, or 40 db. greater than the undesired carrier amplitude for a 40-db. signal to beat-note ratio. For F.M. 75 it need be only 10 db., or 3 times greater. For F.M. 30 it need be only 17.5 db. or 8 times greater. For F.M. 15, it need be only 24 db., or 10.5 times greater.

The result is that F.M. stations can be located much closer geographically, and therefore many more station assignments can be made per channel. All interference due to sky-wave transmission from distant stations is automatically rejected in F.M. because the interfering signals never reach the high amplitude required. This is not so in A.M. transmission.

Figure 10 shows the results of adjacent-channel measurements using one of the RCA Field Test receivers and 2 commercial models of other manufacture. It should be noted that the undesired station was modulated with fixed tone of uniformly high modulating level. As a result the interference was probably somewhat more severe than would be the case for program transmission in which the average modulating level is rather low.

Theory and Design Considerations of

R. F. AND I. F. COILS IN F. M. RECEIVERS

DURING the last 12 months radio literature has contained a number of articles dealing with the various phases of Frequency Modulation from receiver design to antennas and service. (*) Today the average reader of *Radio-Craft* is on speaking terms with F.M. even though situated in localities not yet having the benefits of F.M. service.

It is our plan not to describe any particular F.M. receiver or the operation of the various circuits in an F.M. receiver since this has been so well covered in the past. The art is new and rapidly progressing; the information which has been printed requires no summary and we shall therefore devote this article to the design and theory of the various coils and I.F. Transformers used in a representative F.M. receiver.

The ability of an F.M. receiver to receive and demodulate commercial wide-band F.M. transmissions depends on the band-width

which the amplifier is able to accept, and since this band-width is determined chiefly by the I.F. characteristics, we shall discuss the I.F. amplifier before turning to the R.F. and Oscillator stages.

THE I.F. STAGE—4.3 MC.

The Radio Manufacturers Association, after considerable deliberation, selected a frequency of 4.3 megacycles as a recommended intermediate frequency for use in F.M. receivers since a frequency above 4 mc. precludes the possibility of image frequency interference within the band of 42-50 mc. An I.F. of 4.3 mc. provides a *guard band* between the amateur 3.5-4 mc. band and the 75 kc. transmitter frequency excursion. Thus the first design factor, the frequency, is already established.

The *ideal overall response* of a perfect I.F. amplifier for use with present transmission standards is shown in Fig. 1, at *a*.

*See listing at end of article.

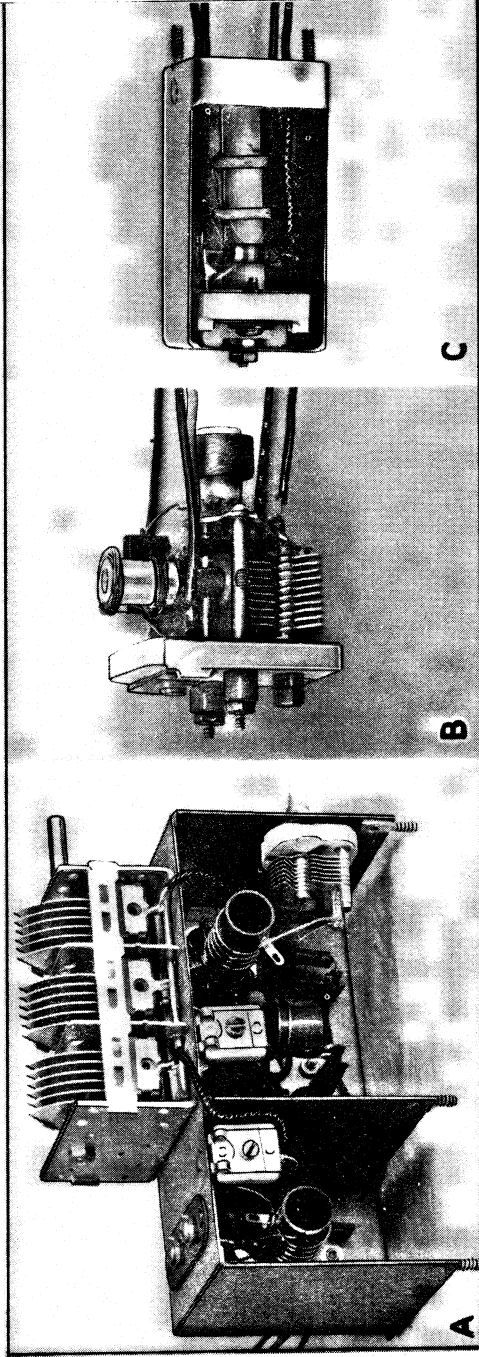

Practical coil arrangements. A—Wired and tested R.F. and oscillator tuning assembly; B—F.M. discriminator transformer, with combined "air and mica tuning"; removed to show ceramic winding forms; C—F.M.-I.F. transformer for 4.3 mc. (can is 2 1/2 ins. long). Carron coils are illustrated.

Fortunately, this curve does not have to be duplicated since the action of the limiter tends to remove all increments in amplitude beyond a certain level as determined in the design of the receiver. The dotted line represents a suitable level of about 4 volts at the limiter grid.

Band-pass.—If then, we design an amplifier having a curve such as *b* in the same figure and depend on the limiter to operate as before, we may retain the ability to align the tuned circuits with an ordinary unmodulated signal at 4.3 mc. and still have essentially the same band-width characteristics as the ideal band-width curve shown at *a*. By using a curve of this shape, maximum band-width is not obtained at full receiver sensitivity, but this sensitivity would

not be usable in any case, since the ability of the limiter to remove all traces of amplitude modulation, static, etc., requires a signal of about 4V. as already stated. In addition, the ability of the limiter to discriminate against amplitude changes increases in proportion to the I.F. signal available at its grid.

Band-pass characteristics such as we require may be obtained by the use of tuned circuits, coupled by a mutual coupling, the value of which determines the pass band. Consulting Fig. 2 and disregarding for the moment the fact that several of the curves have pronounced "double humps," we see that 2 circuits of constant "Q" and having various degrees of coupling designated as *k*, exhibit various band-widths from which

we may make our selection. The value of *k* may be predicted with sufficient accuracy from the formula:

$$(1) \frac{\text{Width of Pass Band}}{\text{Mean Intermediate Frequency}} = k$$

$$(2) M = k \sqrt{L_p \cdot L_s}$$

after which the mutual inductance, *M*, may be set to the proper value from:

In practice this value is set approximately. Final adjustment is made in the actual amplifier, since unknowns in the form of unpredictable capacitive and inductive coupling occur. These may increase or decrease the effective coupling.

Although a satisfactory curve could be

ALL ABOUT FREQUENCY MODULATION

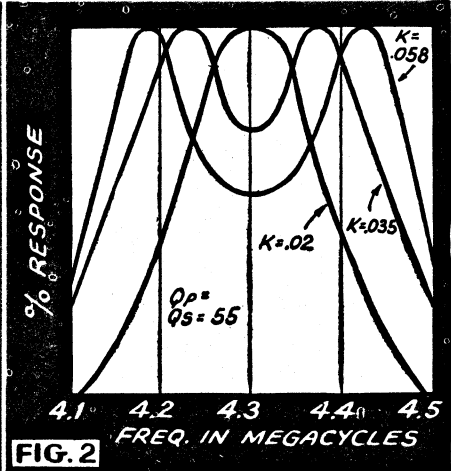
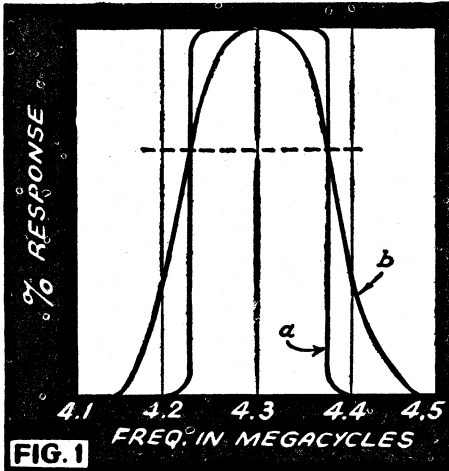

selected from Fig. 2 curve $k = .035$, we find that it has 2 distinct peaks with an area of reduced response between them, a condition entirely unsuitable for F.M. reception. Consult now, curve $Q = 55$ in Fig. 3 which represents 2 tuned circuits having a value of $k = .035$ suitable for our purpose but having the same "double hump" response. If we vary the Q of the coupled circuits, maintaining the coefficient of coupling constant, we may alter the "double humped" response to any intermediate value. Bearing in mind the action of the limiter, and the band-width selected, we find that by employing tuned circuits having a Q of 40 a satisfactory response is secured. This value of Q may be calculated from the formula:

$$(3) \quad \sqrt{Q_p Q_s} = \frac{1.4}{k} \quad \text{or} \quad Q_p = Q_s = 40$$

If we desire the curve to be essentially "flat topped" the formula would read:

$$(4) \quad \sqrt{Q_p Q_s} = \frac{1.5}{k} \quad \text{or} \quad Q_p = Q_s = 42.9$$

Q.—There are several methods of obtaining the required value of Q . The coils may be wound on high-loss cores, wound with high-resistance fine wire, or shunted with a value of resistance to lower the Q from a higher value. In actual practice, either the 1st or 3rd method is preferable, since fine wire usually results in finer insulation and increased distributed capacity, resulting in a lower L/C ratio with consequent reduction of resonant impedance. The author prefers the 3rd method in which the coils may be designed for the most satisfactory winding from a mechanical standpoint. This results in coils of consistent

characteristics, which are symmetrically loaded with shunt resistors across the primary and secondary. These resistors have the two-fold purpose of providing (a) the proper Q and (b) a dissipative circuit which prevents the rapidly changing frequency from setting up transients. The latter may be heard as a "fuzz," particularly on loud, high-frequency passages.

L/C Ratio.—Although treated last in this discussion, the L/C ratio of the tuned circuit inductance to its shunt capacity must be borne in mind all during the design of the I.F. transformers. To provide a reasonable amount of gain at the relatively high frequency of 4.3 mc., we must employ as much inductance as possible compatible with stability. We know that the sum of wiring, tube input and output, and coil dis-

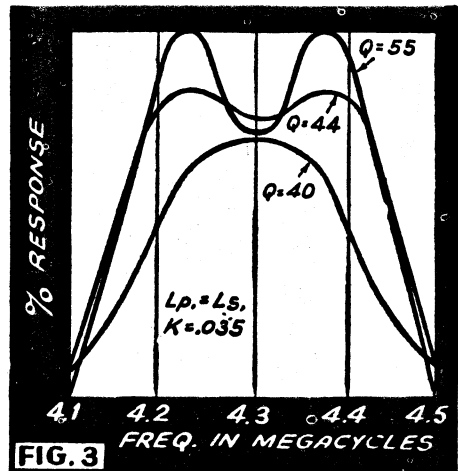

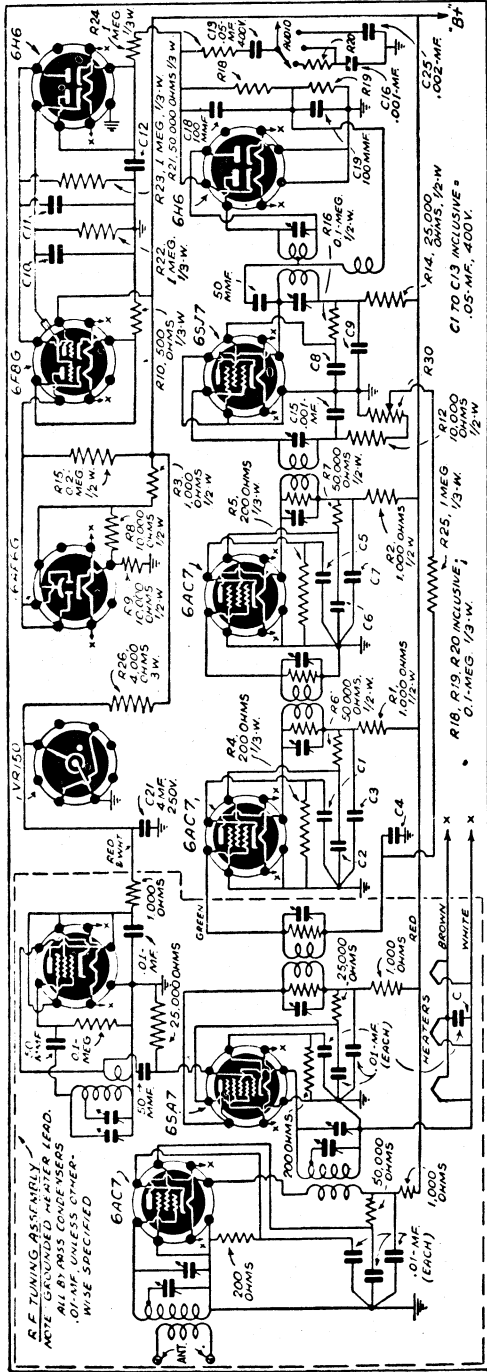

R.F. and I.F. operation of a typical F.M. receiver. Note unit-built R.F. section enclosed within dotted lines. (See NOTE at end of article.)

permeability or air tuning in conjunction with the relatively low Q necessary. Their use would result in unnecessarily increased cost.

So far, we have discussed the I.F. Transformers as a group. Actually we have 3 types: (1) Input/Interstage which are identical, (2) Limiter input, and (3) Discriminator.

The Limiter transformer differs from the Input and Interstage only in that no loading resistor is necessary for the secondary, because it is loaded to a somewhat greater degree by the grid current drawn by the limiter tube. It is permissible to increase the coefficient of coupling in the limiter transformer to maintain the symmetry of the response. The difference in coupling is so

small that it is not practical in production to maintain and is seldom taken into account.

Discriminator-Transformer Design.—Unlike the Limiter, the Discriminator differs considerably from the I.F.s both in mechanical construction and in electrical characteristics. The voltage input to the primary of the Discriminator transformer is practically constant at about 20 volts under usual operation. The voltage delivered to the diode rectifier is not constant, however, and varies with the frequency of the applied signal at any instant. The primary and secondary windings of the discriminator transformer are identical to those of the I.F. transformers. The coupling between the 2 coils is made by means of 2 independent

distributed capacity will be approximately 15 mmf. We have available a midjet trimmer having a mid range or most stable capacity of approximately 50 mmf. This results in a total shunt capacity of 65 mmf. Calculating, we find from substitution in the formula:

$$(5) \quad f = \frac{1}{2\pi \sqrt{LC}}$$

that the required inductance is 21 μH. We then may calculate the approximate mutual inductance between primary and secondary as already mentioned (formula 2). A mica trimmer mounted on a ceramic base is chosen, since no electrical improvement could be obtained from the use of either

ALL ABOUT FREQUENCY MODULATION

dent methods. The coefficient of coupling is selected to give a peak separation of 250 kc. for reasons which will be discussed later. In addition, a capacity is placed between the plate end of the primary and a center-tap on the secondary.

Let us consider the relationship between the voltages in this transformer and their effect on the design. It is necessary for proper discriminator operation that the voltages developed in the 2 halves of the secondary be EXACTLY equal and 180° out-of-phase with each other. This requires an exact electrical center-tap. Even capacities to ground must be equal and a small compensating condenser (a few mmf.) is often placed externally from the ungrounded diode to ground to compensate for the smaller diode capacity of this circuit.

In the operation of the discriminator the secondary is tuned to exact resonance with the mean I.F. Any mis-tuning of this circuit results in phase shift and consequent non-linear operation. Therefore, best design practice dictates that we employ a coil wound on a ceramic form and tuned by means of an air trimmer. The primary winding need not be so exacting since phase shift occurring in this resonant circuit will not affect the operation. For this reason we may use the more economical mica trimmer. The primary must pass the full bandwidth of frequencies from 4,225 to 4,375 kc. with but little frequency discrimination. We will show how this is accomplished. For proper demodulator operation the recovered voltage versus frequency curve should be linear within the frequency deviation encountered.

The response curve of the discriminator, is a combination of the voltages developed across the secondary due to the inductive coupling with the primary, and the primary voltage introduced into the center-tap. In form, it resembles a "double hump" I.F. response curve with one hump reversed to complement the other. This resembles a letter "S" laid on its side. Our object is to make the center of the curve as straight as possible over the range of the frequencies included in the maximum deviation of the transmitter.

Inspection of curve $k = .058$, Fig. 2 will show that the sides of the curve between the mean frequency and 75 kc. are fairly straight. The peak separation in this curve is 250 kc. Using this as a design factor we may construct our discriminator transformer. Although the sides of this curve are not absolutely straight their differences are such that they cancel each other and a linear response vs. frequency results. One other factor, the primary response, affects the shape of the curve. In operation the resistance reflected by the closely-coupled secondary tends to broaden the primary ac-

ceptance band to the full band-width which satisfies the condition mentioned in the beginning of the discussion of the discriminator. No resistance loading is necessary on the secondary as this is provided by the resistance of the diodes and their associated circuits.

R.F. AND OSCILLATOR STAGES

Frequency Modulation transmissions occupy the band between 42 and 50 megacycles. Any experimenter who has built amateur 5-meter receivers is familiar with the small size of the coils and condensers necessary to tune to these frequencies. Several facts, however, are usually overlooked. The length of leads from the coil, size of the variable condenser (length of electrical path), bypass condenser leads, etc., all contribute to the inductance in the circuit. For this reason trouble is usually encountered when gang condenser operation is attempted.

Coil Design in Theory and Practice.—At these frequencies it is ABSOLUTELY IMPOSSIBLE to design a set of coils on paper and expect them to work perfectly. The only method by which perfect results may be obtained is to follow the preliminary design with actual application.

Here the exact circuit and proposed layout are constructed and final inductance adjustment is made. Coils so designed will give the maximum performance in THIS LAYOUT ONLY and any attempt to install them in a similar circuit with a different physical arrangement will give unsatisfactory results. For this reason manufacturers who supply F.M. components in kit form generally furnish the complete R.F. and Oscillator sub-assembly completely wired and tested. Commercial receiver manufacturers are specific in their service notes to the extent of stating: "If it becomes necessary to replace any part be sure to put the replacement part in the exact position occupied by the defective part and use exactly the same lead length originally employed." Bearing these remarks in mind we will proceed with the actual coil design.

Condenser Tuning-Ratio.—As stated, we wish to cover a range of 42-50 mc. If we use a condenser to tune to these frequencies we may employ the formula for inductance, capacity and frequency to determine the tuning ratio of the variable condenser (ratio of total minimum capacity to maximum capacity). To permit a slight space at each end of the dial we assume a range greater than actually required and in the case of F.M. our total range will be 39-51 mc. If the inductance L is held constant we will require a condenser ratio which is equal to the square of the frequency ratio. We will therefore have:

ALL ABOUT FREQUENCY MODULATION

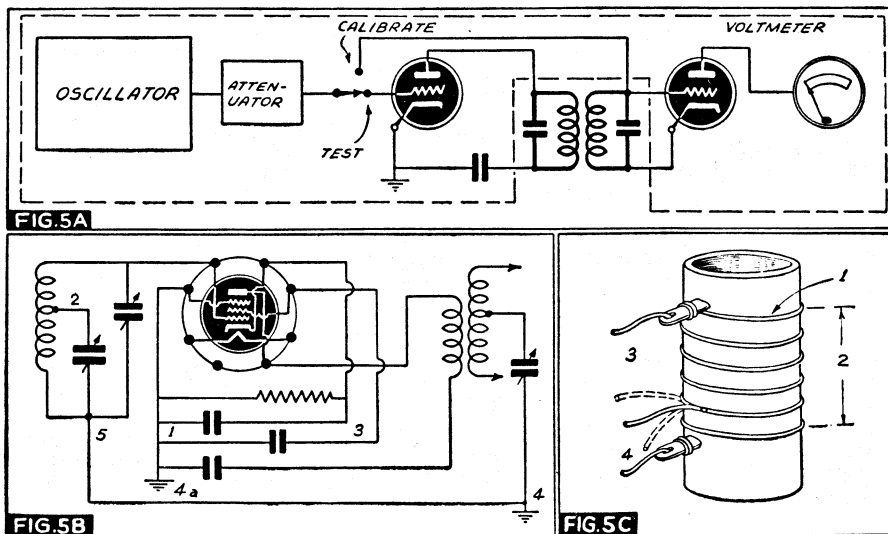

Fig. 5—Testing and applicational circuits. A—Block diagrams of coil-testing setup with which final adjustments are made. Band-width and gain-per-stage may be measured by means of the instrument represented here. B—Diagram showing the introduction of undesired inductance at (1) due to bypassing through a long lead to ground; (2) long lead to tuning condenser; (3) long lead to screen-grid, with regeneration introduced due to the common inductance of the ground path between the gang and ground (4) and bypass ground (4a). Long lead (5) contributes inductances to the tuned circuit but introduces a loss of gain. C—Detail showing how overall inductance may be increased by moving turns as shown by 1, or decreased, 2; or the effective tap position raised, 3, or lowered, 4. Larger changes in tap (tracking) position may be made by moving the position of the turns above and below the tap.

$$(6) \left(\frac{51 \text{ mc.}}{39 \text{ mc.}} \right)^2 = \text{Condenser ratio} = 1.71$$

This value 1.71 is very small and is not ordinarily obtained with any available variable condenser. There are, however, several solutions to this problem:

(1) We may place a large shunt capacity across the coils and use a small variable capacity for actual tuning. This method has the disadvantage that unless the coils are very small, an extremely small variable condenser is required for tuning. If the inductance is reduced the L/C ratio becomes unfavorable, the parallel resonant impedance is lowered and the available gain is small.

(2) A small series condenser (semi-fixed) may be used between the coil and the tuning condenser. From the loss of gain standpoint this method is superior to Method 1. It has several disadvantages such as critical adjustment (stray capacities), and difficulty in obtaining proper tracking between the oscillator and R.F. stages.

(3) A combination of both these systems may be used which will result in retaining the better features of both. This consists of placing a small semi-fixed trimmer directly across the coils to provide alignment at the high-frequency end of the band. A standard small variable tuning condenser

may be tapped down on the coils. This tap has the same effect in limiting the tuning range as the series condenser in Method 2. It has the additional advantage that adjustment of the inductance above and below the tap allows us to vary the tuning ratio and accomplish tracking over the narrow band required.

Its disadvantages lie in a somewhat higher distributed capacity and a tendency to resonate at 2 distinct frequencies. This latter fault is not important in a superheterodyne, since the effect is such that it is impossible for the oscillator to beat with the undesired frequency to produce the I.F. No padding condenser is necessary with this circuit (general high-frequency practice usually eliminates the padding condenser) as this adjustment may be made by as simple a procedure as bending the tap lead where it leaves the coil. By this means its mutual inductance may be added or subtracted from the effective inductance tuned.

Design Example.—For the sake of design let us use Method 3. Connect a small “high-lift low-capacity trimmer” across each coil, assuming a wiring and input capacity, plus trimmer capacity, of 22 mmf. for R.F. and Oscillator circuits. For the time, ignoring the maximum tuning capacity, we can calculate the inductance necessary to resonate at the highest frequency (51 mc). Employing formula (5).

ALL ABOUT FREQUENCY MODULATION

We find the required value to be approximately .44 μ H. This value may be obtained by winding 5 turns of No. 18 bare wire, spaced twice its diameter, on a $\frac{3}{8}$ -in. O.D. bakelite tube. Using this value of inductance we find by again substituting in formula (5) that approximately 37.7 mmf. will be required to tune to 39 mc. Rather than use a small condenser (37.7 mmf. - 22 mmf. = 15.7 mmf.) as a tuning condenser we may choose a condenser several times as large and tap down on the inductance to give the same result. If we select a condenser having a range of about 90 to 100 mmf. we may tap down to about 1/6th of the total inductance. This method of design neglects the minimum capacity of the tuning condenser but due to the impossibility of designing these coils without actual application, this discrepancy may be corrected in the final adjustment. This method permits us to utilize approximately 80% of the condenser rotation to cover the required band, resulting in an easily read dial.

R.F. and Antenna Primaries.—The design of the R.F. and Antenna primaries also represent a compromise, since extreme care must be taken to keep the capacity between the primary and secondary low. One of the most satisfactory methods is to space-wind the primary between the spaced turns of the secondary. Care must also be taken to prevent the R.F. primary from resonating with the tube output and wiring capacity, within the band employed. Since at best, the impedance of the primary as presented to the plate of the preceding tube is far too low to permit a reasonable amount of gain, it is necessary to use as much inductance in the primary as possible, without conflicting with the conditions mentioned. A ratio of 2 primary turns to 3 secondary turns represents a workable value.

The antenna primary is a less critical matter. The impedance reflected into a transmission line from a doublet antenna should be approximately 70 to 100 ohms. The impedance of the primary may be considered as the sum of the impedances of the primary alone plus that coupled into it by the secondary. This coupled impedance is equal to:

$$(7) \quad \frac{(2\pi M)^2}{Z_s}$$

where M is the mutual inductance between primary and secondary and Z_s is the parallel resonant impedance of the secondary.

The condition for maximum transfer of energy is such that the coupled impedance

is equal to the primary impedance and the coupled reactance is equal but opposite in sign to the primary reactance. Formulas have been developed for the calculation of the ideal conditions, but due to their complexity they are seldom used and the same variables as we encountered with the design of the I.F. transformers affect the coupling and alter it from the calculated value.

For our purpose we may calculate the primary impedance based on about $\frac{1}{2}$ the desired impedance and from formula (7) and a knowledge of the effective circuit Q determine the approximate required mutual inductance. We may assume that the coupled reactance will approach the required value and from this starting point the primary may be constructed. On the R.F. coils mentioned above this results in 2 turns interwound with the primary starting $\frac{1}{2}$ -turn outside of the end secondary turn.

Oscillator Coils.—The exact construction of the oscillator coil will depend on the type of circuit employed. Electron-coupled oscillators may be used with the 6SA7 or with a separate electron-coupled oscillator. These circuits require a tapped coil.

The position of the tap should be determined experimentally to give the most suitable amount of feedback. Coupling should be close in any case (interwound if a 6A8 converter is used). The oscillator inductance should be adjusted to a slightly lower value than that used in the R.F. stages and a ceramic-insulated air trimmer should be employed to assure permanence of dial calibration and freedom from drift.

By this time the reader has probably come to the conclusion that the design of tuned circuits for frequencies such as employed in F.M. is a rather haphazard business. This is true to a certain extent. We should remember that the principles involved, are a starting point in the design, and their use at lower frequencies may be made with greater accuracy. At these lower frequencies stray capacity and lead lengths do not represent so large a proportion of the total circuit constants.

Note.—In the bank of 3 condensers which are bypasses for the input 6A7 tube, the unit which bypasses the 1,000-ohm filter resistor to ground should be instead a 0.001-mf. mica condenser.

It may be of interest to note that condenser C which shunts the heaters serves only to reduce the impedance of the heater circuit close to the sockets of the assembly. This is necessary because of the relatively long heater wires which have considerable inductance and which therefore may, under certain conditions, allow a certain amount of feedback between these tubes.

F.M. PHONO PICKUP

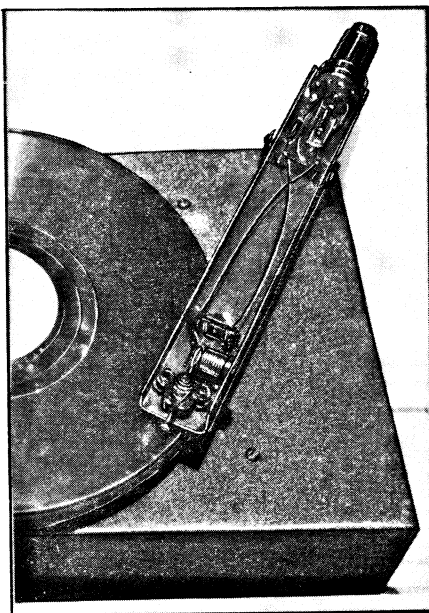

Pictorial illustration of the new F.M. Phono Pickup shown in more detail in Fig. 1.

HARD on the heels of Frequency Modulation broadcasting comes this ingenious development of a Bridgeport, Conn., radio man. Here for the first time in any radio magazine are the complete details for the home construction of this "wireless" *F.M. Phono Pickup*, a unit which bids fair to replace, in time, all other types of pickups. Patent applications have been made by its inventor.

FIDELITY

The most amazing thing about this Frequency Modulation Pickup, developed by Leslie A. Gould, is its extreme simplicity. If this were its only achievement the new instrument would be outstanding; but it goes much further! Its fidelity range—the band of audio frequencies which it is able to transmit—is said to go considerably beyond that of the ordinary crystal and magnetic types. Being a Frequency-Modulated device, its inherent range of frequencies is

limited primarily by the mechanical serrations in the record groove.

What is the frequency range? It must be remembered that this is an experimental pickup. More highly engineered commercial models would undoubtedly exhibit better performance. Therefore it is especially interesting to note that as nearly as the inventor can judge the frequency response of the model here illustrated is approximately 16 to 8,000 cycles. It is expected that with an improved stylus holder it should be quite possible to reproduce up to 15,000 cycles. The latter frequency "top" of course presupposes that the recording extends out to this high frequency.

However the bottle-neck in present-day phono record reproduction is not in the recording but in playback. How does the output voltage compare with crystal and magnetic units? With present models, approximately the same. Whereas formerly, the various types of pickups were used as a means for modulating a carrier frequency generated by any other instrument such as an oscillating tube this unit performs the functions of both. The R.F.-carrier frequency generated by a built-in vacuum tube

is shifted back and forth in frequency, a process which in itself is a form of modulation.

CIRCUIT

Have
YOU
The
Complete
List?

A much better picture of the extreme simplicity of this device may be had by referring to the circuit shown in Fig. 3. Here a type 6C5 is used as an oscillator tube in the simplest type of oscillatory circuit imaginable. To get down to the Frequency Modulation band an oscillator coil consisting of 9 turns of No. 20 enameled wire wound on a ½-in. *lucite* form is used. This coil is mounted at the forward end of the pickup.

Like any other oscillatory circuit, any metal placed in the vicinity of this oscillat-

Read
RADIO-
CRAFT
LIBRARY
BOOK
SERIES

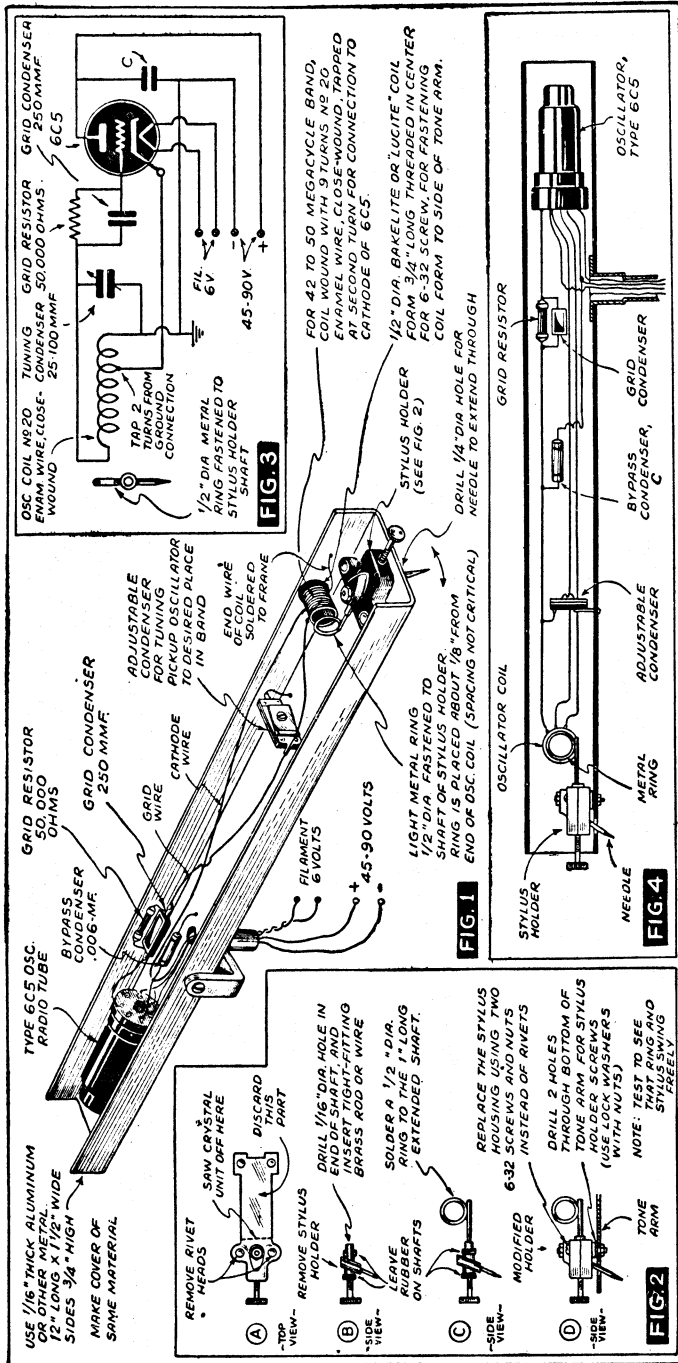

Construction details of the new Frequency Modulation Photo Pickup system. The circuit of the accompanying F.M. oscillator is given in Fig. 3.

ing coil will change the frequency of the circuit. Capitalizing on this phenomenon, Mr. Gould mounts a small metal ring adjacent to this oscillating coil, and since the ring is mechanically fixed to the needle-holding stylus or armature, the vibration of the needle is translated into the

mechanical motion of the metal ring which in turn shifts the frequency of the circuit back and forth over the definite range determined by the recording.

That is the entire unit. Few resonance points, no expensive parts, no complicated electromechanical systems requiring delicate

armatures, and crystals or permanent-magnets.

CONSTRUCTION

Details for the construction of this pickup may be obtained from the various illustrations which accompany this article. These

ALL ABOUT FREQUENCY MODULATION

are explanatory and complete in themselves.

The body of the pickup was made from an old, cast-off crystal pickup. The oscillator tube for shortest possible leads is mounted directly on the pickup arm. The reader may wish to improve upon the method of mounting the stylus and can usually do so. The method shown in the drawings is simple and very effective. However, there is no question but what better methods can be found and employed. It is merely necessary to say that the minimum amount of friction or damping should be used in the mechanical attachment of this stylus to the arm, since the frequency range of the unit is limited mainly by its mechanical system.

The ½-in. ring used in this pickup can be an ordinary brass curtain ring found in most 5c-and-10c stores. These rings, being hollow, and very light and stiff, are ideal for the purpose. When soldering the ring to the stylus shaft use as little solder as possible thereby keeping the stylus as light

in weight as possible which will give the best results on the high-frequency portion of audio reproduction.

"WIRELESS" PHONO-OSCILLATOR

No antenna is necessary. The pickup transmits a Frequency-Modulated wave direct to your F.M. radio receiver up to 50 ft., or above, under usual conditions. If an antenna is desired, a short piece of insulated wire about 6 ins. long can be connected to the cathode terminal of the radio tube socket and allowed to extend through the rear end of the tone arm.

The F.M. signal from this pickup can also be received on a superregenerative type of receiver. It may be necessary in some locations that are noisy to disconnect the regular antenna of your F.M. Receiver and connect in its place a short, 1-wire antenna about 3 to 6 ft. long when tuning-in on this pickup.

List of Articles in Past Issues of *Radio-Craft* on Frequency Modulation

- New Circuits in Modern Radio Receivers (Dept.):
"New Circuit Using 'Electric Eye' as F.M. Tuning Indicator" (Pilot); "Direct-Coupled Limiter Tubes Used in F.M. Receiver" (Zenith), April 1941. "Frequency Modulation Receiver uses 2 Limiters in Cascade" (Scott), Dec. '40. "Supplementary Shadows Indicate F.M. Resonance" (Meissner), Nov. '40. "Pushbutton Amplitude-Frequency Modulation Changeover" (Stromberg-Carlson), Aug. '40. "Same Tuning Indicator Used Both for Amplitude and Frequency Modulation Receiver" (Stromberg-Carlson), "Tuning Indicator for Frequency-Modulation Receiver" (Stromberg-Carlson), March '40.
- Recent Improvements in F.M.-Receiver Design, March 1941.
- A New A.F.-Drift Correcting, Signal-Balancing, Direct-Coupled F.M. 24-Watt Audio Amplifier, Part I, Dec. '40; Part II, Jan. '41; Part III, Feb. '41.
- Circuit Features of the Latest Ultra-H.F. "DX" F.M.-A.M. Receiver, Feb. '41.
- F.M. Servicing Pointers, Jan. '41.
- The ABC of Frequency Modulation, Dec. '40.
- Station WOR Gets F.M. Voice, Dec. '40.
- Present Status of F.M. Broadcasting, Dec. '40.
- F.M. Servicing Procedure, Nov. '40.
- Servicing F.M. Receivers, Oct. '40.
- Servicing F.M. Receivers, Sept. '40.
- Latest 28-Tube DeLuxe High-Fidelity F.M. and A.M. Broadcast Receiver, Sept. '40.
- Build This Practical F.M. Adapter, Aug. '40.
- Choosing an F.M. Antenna, July '40.
- Data Sheets (Dept.): "Stromberg-Carlson, No. 425 Frequency Modulation Receiver and 'Converter'," Feb. '40.
- Frequency-Modulated Programs on Your Present Receiver!—with This Easily-Built F.M.-A.M. Ultra-Shortwave Adapter, Part I, Dec. '39; Part II, Jan. '40.